

AXOR®

hansgrohe

DE	Montageanleitung	2
FR	Instructions de montage	3
EN	assembly instructions	4
IT	Istruzioni per Installazione	5
ES	Instrucciones de montaje	6
NL	Handleiding	7
DK	Monteringsvejledning	8
PT	Manual de Instalação	9
PL	Instrukcja montażu	10
CS	Montážní návod	11
SK	Montážny návod	12
ZH	组装说明	13
RU	Инструкция по монтажу	14
HU	Szerelési útmutató	15
FI	Asennusohje	16
SV	Monteringsanvisning	17
LT	Montavimo instrukcijos	18
HR	Uputstva za instalaciju	19
TR	Montaj kılavuzu	20
RO	Instrucțiuni de montare	21
EL	Οδηγία συναρμολόγησης	22
SL	Navodila za montažo	23
ET	Paigaldusjuhend	24
LV	Montāžas instrukcija	25
SR	Uputstvo za montažu	26
NO	Montasjeveiledning	27
BG	Инструкция за употреба	28
SQ	Udhëzime rreth montimit	29
AR	تعليمات التجميع	30

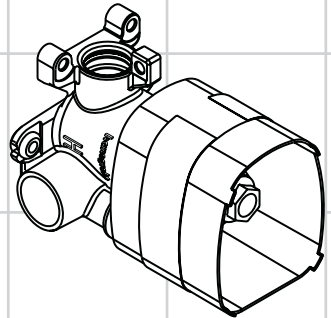

Starck
10754180



Montagewerkzeug/ Montageabfolge



Maße



Technische Daten



Hinweis

Weist das betreffende Personal auf Informationen hin, deren Inhalt wichtig ist und berücksichtigt werden soll.



Wasseranschluss

Warmwasser



Wasseranschluss

Kaltwasser



Elektroinstallateur

Die Installations- und Prüfungsarbeiten sind von einer zugelassenen Elektrofachkraft, unter Berücksichtigung von VDE 0100 Teil 701 u. IEC 60364-7-701, auszuführen.

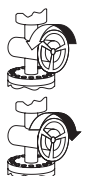

Wasser an / aus



Montageabfolge



Silikon (essigsäurefrei!)



Abgänge abstopfen

Der nicht benötigte Abgang muss mit einem Blindstopfen abgedichtet werden.



Leitungsgefälle

Wasserleitungen für Seitenbrausen mit Gefälle verlegen.

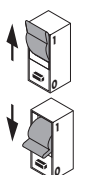

Strom an / aus



Leerrohr EN20

PE Potentialausgleich

N Nullleiter

L Leiter

FI FI-Schutzschalter



Lichtschalter



Transformator



Leuchtmittel



Steckverbindungen



Verstärker für Lautsprecher



Mitte Duschkabine



Wandverstärkung notwendig

In diesem Bereich ist eine Wandverstärkung notwendig.



Prüfzeichen



Anordnung der Module

Die Anordnung der Module den baulichen Gegebenheiten anpassen. (Montagebeispiele siehe Seite 32 bis Seite 51.)

Befestigungsmaterial

Es darf nur geeignetes Befestigungsmaterial verwendet werden! Die beigelegten Schrauben und Dübel sind nur für Beton geeignet.

Spülen

Komplette Installation gemäß DIN 1988 / EN 1717 spülen.

Ablaufleistung

Die Ablaufleistung muss ausreichend dimensioniert werden.

Rückflussverhinderer

Rückflussverhinderer müssen gemäß DIN EN 1717 regelmäßig in Übereinstimmung mit nationalen oder regionalen Bestimmungen (DIN 1988 einmal jährlich) auf ihre Funktion geprüft werden.



Technische Daten

Betriebsdruck:	max. 1,0 MPa
Empfohlener Betriebsdruck:	0,15 - 0,6 MPa
Prüfdruck:	1,6 MPa
Heißwassertemperatur:	max. 80° C
Empfohlene Heißwassertemperatur:	65° C
Anschlüsse	G 3/4
Durchflussleistung bei 0,3 MPa:	
10750180 1 Verbraucher	44 l/min
10750180 2 Verbraucher	55 l/min
10650180	25 l/min
10971180	55 l/min
28486180	50 l/min



Elektroanschluss

Stromversorgung 230V/N/PE/50Hz (Länge: 0,3 m) vorinstallieren. Bei der Elektroinstallation sind die entsprechenden VDE-, Landes- und EVU-Vorschriften in der jeweils gültigen Fassung einzuhalten.

Fehlerstrom-Schutzeinrichtung

Die Absicherung muss über eine Fehlerstrom-Schutzeinrichtung (RCD/ FI) mit einem Bemessungsdifferenzstrom ≤ 30 mA erfolgen.

**Outil de montage/ Ordre du montage****Dimensions****Informations techniques****Remarque**

Attire l'attention du personnel correspondant sur des informations dont le contenu est important et doit être respecté.

**Raccord d'eau**

Eau chaude

**Raccord d'eau**

Eau froide

**Électricien installateur**

Les travaux d'installation et de contrôle doivent être effectués par un électricien agréé en conformité avec les dispositions des normes VDE 0100 partie 701 et CEI 60364-7-701.

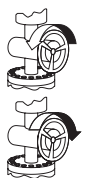
**Eau marche / arrêt****Ordre du montage****Silicone (sans acide acétique!)****Obturer les sorties**

La sortie non utilisée doit être condamnée avec un bouchon laiton.

**Dénivellation des conduites**

La tuyauterie des douchettes latérales à installer avec une pente.

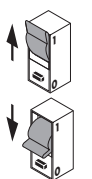
**Courant marche / arrêt****Tube vide EN20****PE Compensation de potentiel****N Neutre****L Conducteur****FI Disjoncteur FI****Interrupteur d'éclairage****transfo****Moyen d'éclairage****Connecteur****Amplificateur pour haut-parleur****Milieu de la cabine douche****Renforcement de la paroi nécessaire**

Le mur n'a pas besoin d'être renforcé à cet endroit

**Classification acoustique et débit****Disposition des modules**

Adapter la disposition des modules aux conditions locales (Exemples de montage aux pages 32 à 51.)

Matériel de fixation

On ne pourra utiliser que des produits de fixation appropriés! Les vis et les chevilles livrées ne conviennent qu'au mur en béton.

Rinçage

Rincer l'installation complète conformément à la réglementation et aux normes.

Débit d'écoulement

Le débit du vidage doit être suffisamment dimensionné.

clapet anti-retour

Les clapets anti-retour doivent être examinés régulièrement conformément à la norme EN 1717 ou conformément aux dispositions nationales ou régionales quant à leur fonction (au moins une fois par an).

**Informations techniques**

Pression de service autorisée:	max. 1,0 MPa
Pression de service conseillée:	0,15 - 0,6 MPa
Pression maximum de contrôle:	1,6 MPa
Température d'eau chaude:	max. 80° C
Température recommandée:	65° C
Raccordement	G 3/4
Débit à 0,3 MPa:	
10750180 1 Consommateur	44 l/min
10750180 2 Consommateur	55 l/min
10650180	25 l/min
10971180	55 l/min
28486180	50 l/min

**Electrical connection**

Préinstaller l'alimentation électrique 230V/N/PE/50Hz (longueur : 0,3 m)
Respecter les consignes VDE, nationale et EVU correspondantes, dans leur version en vigueur.

Dispositif de protection à courant de défaut

La protection par fusibles doit se faire avec un dispositif de protection par courant de défaut (RCD/ FI) avec un courant différentiel résiduel de maximum 30 mA.



Installation tool/ Installation sequence



Dimensions



Technical Data



Note

Points out information to the affected personnel, whose content is important and must be taken into consideration.



Water connection

Warm water



Water connection

Cold water



Electrician

The installation and testing work must be performed by a skilled electrician in observance of VDE 0100 part 701 and IEC 60364-7-701.

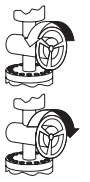

Water on / off



Installation sequence



Silicone (free from acetic acid!)



Plug outlets

Plug the unused outlet.



Pipe decline

Install water pipes for body showers with a gradient.



Electricity on / off



Empty pipe EN20

PE Potential equalisation

N neutral conductor

L conductor

FI FI protective switch



light switch



transformer



Illuminant



connectors



Amplifier for speaker



Middle of shower stall



Area for required wall reinforcement

The wall must be reinforced in this area.



Test certificate



Arrangement of the modules

Adjust the module arrangement to the local conditions (Installation examples see pages 32...51.)

Fastening material

Only suitable fastening material may be used! The enclosed screws and plugs are only suitable for concrete.

Flush piping system

To complete the installation flush out both hot and cold water supply.

Sequence power

The performance of the waste must be of sufficient size.

non return valve

The non return valves must be checked regularly according to DIN EN 1717 in accordance with national or regional regulations (at least once a year).



Technical Data

Operating pressure:	max. 1,0 MPa
Recommended operating pressure:	0,15 - 0,6 MPa
Test pressure:	1,6 MPa
Hot water temperature:	max. 80° C
Recommended hot water temp.:	65° C
Connections	G 3/4
Rate of flow by 0,3 MPa:	
10750180 1 Consumer	44 l/min
10750180 2 Consumer	55 l/min
10650180	25 l/min
10971180	55 l/min
28486180	50 l/min



Electrical connection

Preinstall electrical power 230 V/N/PE/50 Hz (length: 0.3 m)

The current version of the applicable regulations from VDE, local authorities and utility companies must be observed for electric installation work.

Residual current protection system

The system must be protected via a leakage current protective device (RCD/ FI) with a measurement difference current of ≤ 30 mA.

**Attrezzo di montaggio/ Sequenza di montaggio****Ingombri****Dati tecnici****Indicazione**

Rimanda il personale in oggetto a delle informazioni, dove il loro contenuto è importante e che deve essere considerato.

**Allacciamento acqua**

Acqua calda

**Allacciamento acqua**

Acqua fredda

**Installatore elettricista**

I lavori di installazione e di controllo vanno eseguiti da un elettricista specializzato autorizzato, in considerazione della normativa VDE 0100 Parte 701 e IEC 60364-7-701.

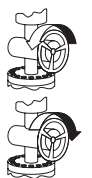
**Acqua ON / OFF****Sequenza di montaggio****Silicone (esente da acido acetico!)****Tappare le uscite**

Chiudere con un tappo l'uscita non utilizzata.

**Pendenza tubi**

Posizionare i tubi alle doccette laterali con una leggera pendenza.

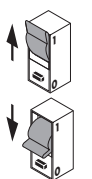
**Corrente ON / OFF****Tubo vuoto EN20****PE Compensazione di potenziale****N conduttore neutro****L conduttore****FI interruttore di sicurezza per correnti di guasto interruttore luce****trasformatore****Lampada****collegamenti a spina****Amplificatore per altoparlante****Centro cabina doccia****Campo rinforzo necessario della parete**

In questa zona è necessario un rinforzo della parete.

**Segno di verifica****Disposizione dei moduli**

Adattare la disposizione dei moduli alle circostanze architettoniche.

(Esempi di montaggio vedi da Pagina 32 a Pagina 51.)

Materiale di fissaggio

Usare esclusivamente del materiale di fissaggio adatto. Le viti ed i tasselli inclusi sono adatti solo per calcestruzzo.

Lavaggio della tubazione

Eseguire il lavaggio della tubazione come suggerisce la normativa DIN 1988 / EN 1717.

Portata di scarico

Lo scarico deve essere sufficientemente dimensionato.

valvola antiriflusso

La valvola di non ritorno deve essere controllata regolarmente come da DIN EN 1717, secondo le normative nazionali e regionali (almeno una volta all'anno).

**Dati tecnici**

Pressione d'uso:	max. 1,0 MPa
Pressione d'uso consigliata:	0,15 - 0,6 MPa
Pressione di prova:	1,6 MPa
Temperatura dell'acqua calda:	max. 80° C
Temp. dell'acqua calda consigliata:	65° C
Raccordi:	G 3/4
Potenza di erogazione a 0,3 MPa:	
10750180 1 Utenza	44 l/min
10750180 2 Utenza	55 l/min
10650180	25 l/min
10971180	55 l/min
28486180	50 l/min

**Allacciamento elettrico**

Preinstallare l'alimentazione elettrica di 230V/N/PE/50Hz (lunghezza: 0,3 m). Per l'installazione elettrica vanno rispettate le corrispondenti prescrizioni VDE, del Paese e EVU nella rispettiva versione valida.

circuito di sicurezza per correnti di guasto

Per protezione bisogna installare un circuito di sicurezza per correnti di guasto (RCD/ FI) con una corrente differenziale nominale di ≤ 30 mA.



**Herramienta de montaje/
Secuencia de montaje**



Dimensiones



Datos técnicos



Nota

Instruye al personal en cuestión sobre temas cuyo contenido es importante y debe tenerse en cuenta.



Conexión de agua

Agua caliente



Conexión de agua

Agua fría



Instalador eléctrico

Las tareas de instalación y prueba únicamente pueden ser realizadas por personal electricista cualificado, respetando las reglamentaciones de las normas VDE 0100, parte 701, e IEC 60364-7-701.

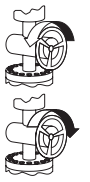

Agua on / off



Secuencia de montaje



Silicona (libre de ácido acético)



Llenar salidas

La salida que no se utiliza debe ser tapada.



Pendiente de la conducción

Tubería hacia las duchas laterales con pendiente.



Corriente on / off



Tubo vacío EN20

PE Protección equipotencial

N Conductor neutro

L Conductor

FI Conmutador de protección FI



Interruptor de luz



Transformador



Luces



Uniones insertables



Amplificador para altavoces



Centro cabina de ducha



Área refuerzo necesario de la pared

En este sector es necesario un refuerzo del muro.



Marca de verificación



Disposición de los módulos

Adaptar la disposición de los módulos a las condiciones constructivas. (Para ejemplos de montaje ver las páginas 32 a 51.)

Material de fijación

¡Usar exclusivamente el material de fijación adecuado! Los tornillos y tarugos incluidos son solamente apropiados para hormigón.

Purga de la tubería

Purgar la instalación según la normativa DIN 1988/ EN 1717.

Capacidad de desagüe

La tubería de desagüe ha de tener una dimensión suficiente.

Válvula antirretorno

Las válvulas anti-retorno tienen que ser controladas regularmente según la norma DIN EN 1717, en acuerdo con las regulaciones nacionales o regionales (una vez al año, por lo menos).



Datos técnicos

Presión en servicio:	max. 1,0 MPa
Presión recomendada en servicio:	0,15 - 0,6 MPa
Presión de prueba:	1,6 MPa
Temperatura del agua caliente:	max. 80° C
Temp. recomendada del agua caliente:	65° C
Racores excéntricos	G 3/4
Caudal a 0,3 MPa:	
10750180 1 Consumidor	44 l/min
10750180 2 Consumidor	55 l/min
10650180	25 l/min
10971180	55 l/min
28486180	50 l/min



Conexión eléctrica

Instalar previamente el suministro eléctrico 230V/N/PE/50Hz (longitud: 0,3 m). Para la instalación eléctrica deben respetarse las disposiciones correspondientes VDE, de cada país, y EVU en su versión vigente.

Dispositivo diferencial residual

La conexión debe establecerse a través de un dispositivo de protección de corriente residual (RCD/ FI) con un interruptor diferencial de corriente ≤ 30 mA.



Montagegreedschap/ Montagevolgorde



Maten



Technische gegevens



Aanwijzing

Wijst het betrokken personeel op informatie waarvan de inhoud belangrijk is en in acht genomen moet worden.



Wateraansluiting

Warm water



Wateraansluiting

Koud water



Electro-installateur

De installatie- en controlewerkzaamheden moeten uitgevoerd worden door een geautoriseerde electricien die rekening houdt met de normen VDE 0100 Deel 701 en IEC 60364-7-701.

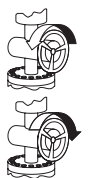

Water aan / uit



Montagevolgorde



Silicone (azijnzuurvrij!)



Aftappunt afsluiten

De niet benodigde uitgang moet met een blindstop worden afgedicht.



Leidingsafloop

Waterleidingen voor zijdouches aflopend plaatsen.

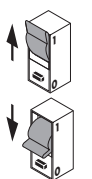

Stroom aan / uit



Legge buis EN20

PE Potentiaalvereffening

N Nulgeleider

L Geleider

FI FI-veiligheidsschakelaar



Lichtschakelaar



trafo



Verlichtingsmiddel



Steekverbinding



Versterker voor luidsprekers



Midden douchecabine



Wandversterking noodzakelijk voor montage

In dit bereik is een wandversterking noodzakelijk.



Keurmerk



Rangschikking van de modules

De rangschikking van de modules moet aan de bouwtechnische omstandigheden worden aangepast (Montagevoorbeelden zie pagina 32 t/m 51)

Bevestigingsmateriaal

Er mag alleen geschikt bevestigingsmateriaal worden gebruikt! De bijgevoegde schroeven en pluggen.

Spoelen

De complete installatie overeenkomstig DIN 1988/ EN 1717 spoelen.

Afvoercapaciteit

De afvoercapaciteit moet voldoende gedimensioneerd worden.

terugslagklep

Keerklappen moeten volgens DIN EN 1717 regelmatig en volgens plaatselijk geldende eisen op het functioneren gecontroleerd worden. (Tenminste een keer per jaar).



Technische gegevens

Werkdruk: max.	max. 1,0 MPa
Aanbevolen werkdruk:	0,15 - 0,6 MPa
Getest bij:	1,6 MPa
Temperatuur warm water:	max. 80° C
Aanbevolen warm water temp.:	65° C
Aansluitingen	G 3/4
Doorvoercapaciteit bij 0,3 MPa:	
10750180 1 Verbruiker	44 l/min
10750180 2 Verbruiker	55 l/min
10650180	25 l/min
10971180	55 l/min
28486180	50 l/min



Elektrische aansluiting

Stroomvoorziening 230V/N/PE/50Hz (lengte: 0,3 m) vooraf installeren. Bij de elektrische installatie moeten de overeenkomstige VDE-, nationale en EVU-voorschriften in de geldige versie in acht genomen worden.

Aardlekschakelaar

Deze moet middels een 2-polige FI-schakelaar met 30mA afgezekerd worden.



Monteringsværktøj/ Monteringsrækkefølge



Målene



Tekniske data



OBS

Henviser personalet til oplysninger, som er vigtige og som der skal tages højde for.



Vandtilslutning

Varmt vand



Vandtilslutning

Kold vand



El-installatør

Installeringen og afprøvningen skal gennemføres af en godkendt el-installatør iht. VDE 0100 part 701 og IEC 60364-7-701.

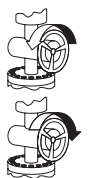

Vand til / fra



Monteringsrækkefølge



Silikone (eddikesyre-fri)



Proppe afløb

Afgangen, der ikke benyttes, skal afproppes.



Ledningsfald

Vandledningerne til sidebruserne med fald.

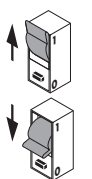

Strøm til / fra



Tomt rør EB20

PE Potentialudligning

N Nulleder

L Leder

FI FI-beskyttelseskontakt



Lyskontakt



Transformere



Lyskilde



Stikforbindelser



Forstærker til højtalere



Med bruserkabine



Område nødvendigvægforstærkning

I dette område er en forstærkning af væggen nødvendig.



Godkendelse



Rangschikning van de modules

Tilpasse modulernes arrangement til bygningssituationen.
(Monteringseksempel se side 32 til side 51.)

Bevestigingsmateriaal

Anvend kun egnet befæstigelsesmateriale. De vedlagte skruer og rawplugs er kun egnet til beton.

Gennemskylning

Den komplette installation skal gennemskylnes efter DIN 1988 / EN 1717.

Afløbskapacitet

Afløbet skal være i en tilstrækkelig størrelse.

Kontraventil

Ifølge DIN EN 1717 skal gennemstrømningsbegrænsere i overensstemmelse med nationale regler afprøves regelmæssigt (mindst en gang om året).



Tekniske data

Driftstryk:	max. 1,0 MPa
Anbefalet driftstryk:	0,15 - 0,6 MPa
Prøvetryk:	1,6 MPa
Varmvandstemperatur:	max. 80° C
Anbefalet varmvandstemperatur:	65° C
Tilslutninger	G 3/4
Gennemstrømningsydelse ved 0,3 MPa:	
10750180 1 Forbruger	44 l/min
10750180 2 Forbruger	55 l/min
10650180	25 l/min
10971180	55 l/min
28486180	50 l/min



El-tilslutning

Strømforsyning 230V/N/PE/50Hz (længde: 0,3 m) allerede installeret.
Ved el-installeringen skal der tages hensyn til branchens forskrifter og de tilsvarende gældende nationale love og forskrifter.

Fjelstrømsbeskyttelses

Sikringen skal køre over en fejlstrømsikring (HFI) med en fejlstrømsdifference ≤ 30 mA.



**Ferramenta de montagem/
Sequência de montagem**



Medidas



Dados Técnicos



Aviso

Adverte os funcionários para informações, cujo conteúdo é importante e tem que ser considerado.



Ligação da água

Água quente



Ligação da água

Água fria



Electricista de construção civil

Os trabalhos de instalação e de controlo devem ser efectuados por um técnico electricista devidamente autorizado e especializado, tendo em consideração as normas VDE 0100 Parte 701 e IEC 60364-7-701.

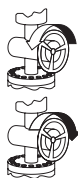

Água ligada/desligada



Sequência de montagem



Silicone (sem ácido acético)



Tapar saídas

Tamponar a saída não utilizada.



Inclinação da tubagem

Instalar os tubos para os chuveiros laterais com ligeira inclinação.

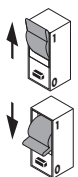

Electricidade ligada/desligada



Tubo vazio EN20

PE Ligação equipotencial

N Condutor neutro

L Condutor

FI Interruptor FI



Interruptor de luz



Transformador



Lâmpada



Tomadas de ligação



Amplificador para altifalante



Centro da cabina de duche



Área reforçada necessária da parede

Nesta zona é necessário um reforço na parede.



Marca de controlo



Disposição dos módulos

Adaptar a disposição dos módulos às características locais.
(Exemplo de montagem, ver página 32 até 51.)

Material de fixação

Apenas deve ser utilizado material de fixação compatível. Os parafusos e buchas incluídos são apenas adequados para betão.

Purgar as tubagens

Para completar a instalação purgar as tubagens da água quente e da água fria.

Capacidade de escoamento

A capacidade de escoamento deve ser devidamente dimensionada.

Válvula anti-retorno

As válvulas anti-retorno devem ser verificadas regularmente de acordo com a DIN EN 1717 segundo os regulamentos nacionais ou regionais (pelo menos uma vez por ano).



Dados Técnicos

Pressão de funcionamento:	max. 1,0 MPa
Pressão de func. recomendada:	0,15 - 0,6 MPa
Pressão testada:	1,6 MPa
Temperatura da água quente:	max. 80° C
Temp. água quente recomendada:	65° C
Ligações	G 3/4
Caudal o 0,3 MPa:	
10750180 1 Consumidor	44 l/min
10750180 2 Consumidor	55 l/min
10650180	25 l/min
10971180	55 l/min
28486180	50 l/min



Ligação eléctrica

Pré-instalar a alimentação eléctrica 230V/N/PE/50Hz (comprimento: 0,3 m).
Na instalação eléctrica deve ser cumprida a versão válida das prescrições VDE, nacionais e EVU.

Dispositivo de protecção para corrente de fuga

A ligação deve estar protegida por um diferencial magneto-térmico bipolar (RRCB) com uma corrente residual ≤ 30 mA.



Narzędzia do wykonania montażu/ Przebieg montażu



Wymiary



Dane techniczne



Wskazówka

Zwraca odpowiedniemu personelowi uwagę na informacje, których treść jest istotna i które należy uwzględnić.



Podłączenie wody

Ciepła woda



Podłączenie wody

Zimna woda



Elektryk instalator

Prace instalacyjne i kontrolne mogą być przeprowadzane jedynie przez wykwalifikowanego elektryka, przestrzegając przepisów z VDE 0100 część 701 i IEC 60364-7-701.

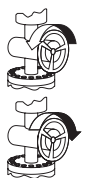

Wł. / wył. wodę



Przebieg montażu



Silikon (neutralny)



Odblokowanie odprowadzeń

Niewykorzystany wylot należy zakorkować dołożonym w dostawie korkiem.



Spadek przewodów

Przewody doprowadzające do pryszniców bocznych położyć z nachyleniem.



Wł. / wył. prąd



Rura osłonowa do prowadzenia przewodów EN20



PE Wyrównanie potencjału

N Przewód zerowy

L Przewód

FI Wyłącznik różnicowoprądowy FI

Wyłącznik oświetleniowy



Transformator



Źródło światła



Połączenia wtykowe



Wzmacniacz do głośnika



Środek kabiny prysznicowej



Niezbędne wzmocnienie ścian

W tym obszarze konieczne jest wzmocnienie ściany.



Znak jakości



Rozmieszczenie modułów

Dopasować rozmieszczenie modułów do warunków budowy. (Przykłady montażu, patrz strony 32 do 52.)

Materiał mocujący

Dopuszczalne jest wykorzystanie tylko odpowiedniego materiału mocującego. Umieszczone w dostawie śruby i kołki rozporowe są przeznaczone tylko do betonu.

Płukanie

Przepłukać całą instalację zgodnie z normą DIN 1988 / EN 1717.

Wydajność odpływu

Odpływ musi mieć wystarczające wymiary.

Zabezpieczenie przed przepływem zwrotnym

Działanie zabezpieczeń przed przepływem zwrotnym, zgodnie z normą DIN EN 1717 i miejscowymi przepisami, musi być kontrolowane (DIN 1988, raz w roku).



Dane techniczne

Ciśnienie robocze:	max. 1,0 MPa
Zalecane ciśnienie robocze:	0,15 - 0,6 MPa
Ciśnienie próbne:	1,6 MPa
Temperatura wody gorącej:	max. 80° C
Zalecana temperatura wody gorącej:	65° C
Przyłącza	G 3/4
Wydajność przepływu przy 0,3 MPa:	
10750180 1 Odbiornik	44 l/min
10750180 2 Odbiornik	55 l/min
10650180	25 l/min
10971180	55 l/min
28486180	50 l/min



Przyłącze elektryczne

Zasilanie prądem 230V/N/PE/50Hz (długość: 0,3 m) zainstalować wstępnie. Przy instalacji elektrycznej należy przestrzegać odpowiednich przepisów krajowych i europejskich w obowiązującej wersji.

Urządzenie ochronne prądowe

Zabezpieczenie instalacji musi mieć miejsce przy użyciu zabezpieczenia różnicowego (RCD/ FI) z różnicą pomiarów wynoszącą ≤ 30 mA.



Montážní nářadí/ Postup montáže



Rozměry



Technické údaje



Upozornění

Upozorňuje dotyčný personál na informace, jejichž obsah je důležitý a je třeba ho zohlednit.



Připojení vody

Teplá voda



Připojení vody

Studená voda



Elektroinstalatér

Instalační práce a přezkoušení musí být provedeno autorizovaným elektrotechnickým odborníkem za zohlednění směrnic VDE 0100, část 701 a IEC 60364-7-701.

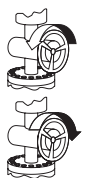

Voda ZAP / VYP



Postup montáže



Silikon (bez kyseliny octové!)



Utěsnit odpady

Nepoužitý vývod musí být utěsněn zaslepovací zátkou.



Spád potrubí

Vodovodní potrubí pro boční sprchy nainstalovat se spádem.



Elektrický proud ZAP / VYP



Ochranná trubka EN20



PE Vyrovnání potenciálů

N Nulový vodič

L Vodič

FI Ochranný spínač FI



Spínač světla



Transformátor



Osvětlovací prostředek



Konektorová spojení



Zesilovač pro reproduktory



Střed sprchového koutu



nutné vyztužení stěny

V této oblasti je potřebné zesílení stěny.



Zkušební značka



Uspořádání modulů

Uspořádání modulů přizpůsobte stavebním podmínkám. (Příklady montáže viz strana 32 až strana 51.)

Upevňující materiál

Použít se smí jen odpovídající upevňovací materiál! Příložené šrouby a hmoždinky jsou vhodné pouze do betonu.

Propláchnutí

Propláchnout kompletní instalaci podle DIN 1988 / EN 1717.

Výkon odtoku

Propustnost odpadu musí být dostatečně dimenzována.

zpětný ventil

U zpětných ventilů se musí podle DIN EN 1717 v souladu s národními nebo regionálními předpisy testovat jejich funkčnost (alespoň jednou ročně).



Technické údaje

Provozní tlak:	max. 1,0 MPa
Doporučený provozní tlak:	0,15 - 0,6 MPa
Zkušební tlak:	1,6 MPa
Teplota horké vody:	max. 80° C
Doporučená teplota horké vody:	65° C
Připoje	G 3/4
Průtokové množství při 0,3 MPa:	
10750180 1 Spotřebič	44 l/min
10750180 2 Spotřebič	55 l/min
10650180	25 l/min
10971180	55 l/min
28486180	50 l/min



Elektrické připojení

Předinstalujte elektrické napájení 230V/N/PE/50Hz délka: 0,3 m)
Při elektroinstalaci musíte dodržet příslušné předpisy VDE a místní předpisy energetických podniků, vždy v platném znění.

Ochranné zařízení chybového proudu

Přívod musí být chráněn proudovým chráničem pro chybový proud (RCD/ FI) s mírným rozdílovým proudem ≤ 30 mA.



Montážne náradie/ Postup montáže



Rozmery



Technické údaje



Upozornenie

Upozorňuje dotyčný personál na informácie, ktorých obsah je dôležitý a má byť zohľadnený.



Pripojenie vody

Teplá voda



Pripojenie vody

Studená voda



Elektroinštalatér

Inštalácie a skúšobné práce musí vykonávať len autorizovaný elektrikár pri zohľadnení noriem VDE 0100, časť 701 a IEC 60364-7-701.

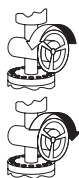

Zap./vyp. vodu



Postup montáže



Silikon (bez kyseliny octovej!)



Utesniť odvody

Nepoužitý vývod musí byť zaslepený zátkou.



Sklon vedenia

Vodovodné potrubie pre bočné sprchy vyspádovať.



Zap./vyp. prúd



Ochranná rúra EN20



PE Vyrovnanie potenciálov

N Nulový vodič

L Vodič

FI FI ochranný spínač



Svetelný spínač



Transformátor



Osvetľovací prostriedok



Konektorové spojenia



Zosilovač pre reproduktory



Stred sprchového kútu



Potrebné zosilnenie steny

V tejto oblasti je potrebné zosilnenie steny.



Osvedčenie o skúške



Usporiadanie modulov

Usporiadanie modulov prispôbajte stavebným podmienkam.
(Príklady montáže vid' na strane 32 až strane 51.)

Upevňujúci materiál

Použiť sa môže len zodpovedajúci upevňovací materiál! Priložené skrutky a hmoždinky sú vhodné iba do betónu.

Prepláchnutie

Kompletná inštalácia podľa DIN 1988 / EN 1717.

Výkon odtoku

Priepustnosť odpadu musí byť dostatočne dimenzovaná.

obmedzovač spätného nasatia

Pri spätných ventiloch sa musí podľa DIN EN 1717 v súlade s národnými alebo regionálnymi predpismi testovať ich funkčnosť (aspoň raz ročne).



Technické údaje

Prevádzkový tlak:	max. 1,0 MPa
Doporučený prevádzkový tlak:	0,15 - 0,6 MPa
Skúšobný tlak:	1,6 MPa
Teplota teplej vody:	max. 80° C
Doporučená teplota teplej vody:	65° C
Pripojenie	G 3/4
Prietokové množstvo pri 0,3 MPa:	
10750180 1 Spotřebič	44 l/min
10750180 2 Spotřebič	55 l/min
10650180	25 l/min
10971180	55 l/min
28486180	50 l/min



Elektrické pripojenie

Predinštalujte zásobovanie elektrinou 230V/N/PE/50Hz (dĺžka: 0,3 m)
Pri elektroinštalácii je nutné dodržiavať príslušné predpisy VDE, krajiny a EVU v príslušnom platnom vydaní.

Ochranné zariadenie chybného prúdu

Prívod musí byť chránený prúdovým chráničom (RCD/FI) pre chybový prúd s merným rozdielovým prúdom ≤ 30 mA.



装配工具/ 装配顺序



大小



技术参数



指示说明

向相关人员指出其内容的重要性并应加以考虑。



水连接

热水



水连接

冷水



电气安装人员

安装和检查工作由有资质的电气专业人员按照德国电气工程协会VDE 0100标准中第701项和国际电工委员会IEC 60364-7-701标准执行。

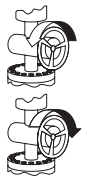

水 接通/断开



装配顺序



硅胶（不含醋酸）



堵塞支路

插入不使用的插座。



管道梯度

安装水管，用于带有梯度的淋浴器。



电流 接通/断开



空管EN20

PE

电位均衡

N

零线

L

导线

FI

FI保护开关



照明开关



变压器



灯具



插座连接



扬声器放大器

X

淋浴室中心



墙壁必要加强的区域

该区域需要一个加固边壁。



检验标记



模块布置

按照构造的实际情况布置模块。（安装范例参见第32页至第51页。）

固定材料

仅可使用合适的紧固材料！附带的螺丝和木钉仅适用于混凝土。

冲洗管系统

要完成安装，冲洗冷热水供水管。

流出功率

废水管的性能必须具有充足的尺寸。

单向阀

单向阀必须在符合国家或当地的法律的情况下按照DIN EN 1717定期检查（至少一年一次）。



技术参数

工作压力:	max. 1,0 MPa
推荐工作压力:	0,15 - 0,6 MPa
测试压强:	1,6 MPa
热水温度:	max. 80° C
推荐热水温度:	65° C
连接管线	G 3/4
流量 钟0,3 MPa:	
10750180 1 用户	44 l/min
10750180 2 用户	55 l/min
10650180	25 l/min
10971180	55 l/min
28486180	50 l/min



电气连接

预安装供电电缆230V/N/PE/50Hz（长度0.3米
在进行电力安装的过程中，遵守有效的德国电工规范以及本国的电力危险防护规定。

缺陷电流保护装置

保险装置必须是额定电流 ≤ 30 mA的故障电流保护装置。



**Монтажный инструмент/
Порядок монтажа**



Размеры



Технические данные



Указание

Соответствующий персонал знакомит с важной информацией, которую необходимо соблюдать.



Подключение воды

Теплая вода



Подключение воды

Холодная вода



Электромонтер

Установочные и проверочные работы проводятся специалистами-электриками, имеющими допуск к работе, с соблюдением VDE 0100, часть 701, и IEC 60364-7-701.

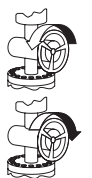

Вода вкл. / выкл.



Порядок монтажа



Силикон (не содержит уксусной кислоты!)



Заглушить отходящие линии

Ненужный выход необходимо уплотнить с помощью заглушки.



Напор провода

Водопроводы для боковых душей прокладывают под наклоном .

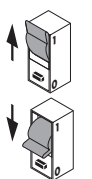

Ток вкл. / выкл.



Пустая труба EN20

PE Выравнивание потенциалов

N Нулевой провод

L Провод

FI Защитное реле FI



Выключатель освещения



трансформатор



Осветительное средство



Штекерные соединения



Усилитель для динамиков



Х Середина душевой кабины



Необходимо усиление стены

В этой области требуется укрепление стены.



Знак технического контроля



Расположение модулей

Подогнать расположение модулей в соответствии с конструктивными параметрами. (См. примеры монтажа на стр. 32-51.)

Крепежный материал

Используйте только специальный крепежный материал! Приложенные винты и дюбели предназначены для работ по бетону.

Промывка

Промывайте все установленное оборудование, согласно DIN 1988 / EN 1717.

Перерабатывающая способность

Слив должен иметь достаточную производительность.

Защита обратного тока воды

Защита обратного тока должна регулярно проверяться (минимум один раз в год) по стандарту DIN EN 1717 или в соответствии с национальными или региональными нормативами



Технические данные

Рабочее давление:	max. 1,0 MPa
Рекомендуемое рабочее давление:	0,15 - 0,6 MPa
Давление:	1,6 MPa
Температура горячей воды:	max. 80° C
Рекомендуемая темп. гор. воды:	65° C
Подключение	G 3/4
Расход при 0,3 МПа:	
10750180 1 Потребитель	44 l/min
10750180 2 Потребитель	55 l/min
10650180	25 l/min
10971180	55 l/min
28486180	50 l/min



Электроподключение

Электропитание 230V/N/PE/50Hz (длина: 0,3 м) установить заранее. При электромонтаже следует соблюдать соответствующие предписания Союза немецких электротехников (VDE), государственные нормы и предписания Европейского объединения исследований несчастных случаев (EVU) в действующей редакции.

Неисправность электрооборудования и защитных приспособлений

Требуется организовать защиту с помощью устройства защитного отключения (выключателя дифференциального тока) с уставкой дифференциального тока ≤ 30 мА.



Szerelési szerszám/ Szerelési sorrend



Méretet



Műszaki adatok



Megjegyzés

Az érintett személyzetet olyan információra figyelmezteti, amelynek tartalma fontos, és figyelembe kell venni.



Vízcsatlakozás

Melegvíz



Vízcsatlakozás

Hidegvíz



Elektromos szakember

Az installációs és ellenőrző munkákat jóváhagyott elektromos szakembernek kell elvégezni, a VDE 0100 701. része és az IEC 60364-7-701, figyelembevételével.

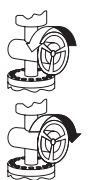

Víz be / ki



Szerelési sorrend



Szilikon (ecetsavmentes!)



Kimeneteket lezárni

A fölösleges kimenetet vakdugóval kell lezárni.



Vezeték esése

Az oldalzuhanyokhoz a vízvezeték lejtéssel ajánlott beszerelni.



Áram be / ki



EN20 üres cső



PE Potenciálkiegyenlítés

N Nullavezető

L Vezető

FI FI-védőkapcsoló



Világításkapcsoló



Trafó



Világítás



Dugaszoló csatlakozások



Erősítő a hangszóróhoz



Zuhanykabin közepe



Szükséges a fal megerősítése

Ezen a területen a fal megerősítésére van szükség.



Vizsgajel



A modulok elrendezése

A modulok elrendezését az építési adottságokhoz kell igazítani.
(A szerelési példát lásd a 32.-51. oldalon.)

Rögzítő anyag

Kizárólag erre a célra való rögzítő anyagokat szabad felhasználni! A mellékelt csavarok és tiplik csak betonhoz használhatók!

Átöblítés

A DIN 1988 / EN 1717 szerint öblítse át a komplett installációt.

Lefolyási teljesítmény

A kifolyási teljesítményt megfelelően kell dimensionálni.

Visszacsapószelep

A visszafolyásgátlók működése a DIN EN 1717 szabványnak megfelelően, a nemzeti vagy területi rendelkezésekkel összhangban, évente egyszer ellenőrizendő!



Műszaki adatok

Üzemi nyomás:	max. 1,0 MPa
Ajánlott üzemi nyomás:	0,15 - 0,6 MPa
Nyomáspróba:	1,6 MPa
Forróvíz hőmérséklet:	max. 80° C
Forróvíz javasolt hőmérséklete:	65° C
Csatlakozás	G 3/4
Átfolyási teljesítmény 0,3 MPa:	
10750180 1 Felhasználó	44 l/min
10750180 2 Felhasználó	55 l/min
10650180	25 l/min
10971180	55 l/min
28486180	50 l/min



Elektromos csatlakozás

Áramellátást 230V/N/PE/50Hz (hosszúság: 0,3 m) előre telepíteni.

Az elektromos szerelés közben a mindenkor érvényes keretek között be kell tartani a megfelelő VDE, országspecifikus, és EVU előírásokat.

Hibaáram-védőberendezés

A biztosítást egy hibaáram-mentesítő (RCD/ FI) útján, egy 30 mA-nál kisebb hálózati váltóáram segítségével kell megvalósítani.



Asennustyökalu/ Asennusjärjestys



Mitat



Tekniset tiedot



Huomautus

Osoittaa asiaankuuluvalla henkilökunnalle tietoja, jotka ovat tärkeitä ja joita tulee noudattaa.



Vesiliitäntä

Lämmin vesi



Vesiliitäntä

Kylmä vesi



Sähköasentaja

Hyväksytyn sähköammattilaisen on suoritettava sähköasennus- ja tarkastustyöt VDE 0100 osa 701 ja IEC 60364-7-701 mukaisesti.

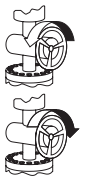

Vesi auki / kiinni



Asennusjärjestys



Silikoni (etikkahappovapaa!)



Poistokohdat tukitaan

Käyttämätön lähtöliitin on suljettava sulkutulpalla.



Putkien kaltevuus

Vie sivusuihkujen syöttöputket alaspäin laskevasti.



Sähkö päällä / pois päältä



Asennusputki EN20



PE Potentiaalitasaus

N Nollajohdin

L Johdin

FI FI-suojakytkin



Valokytkin



Muuntaja



Valonlähde



Pistokeliitäntä



Kaiuttimien vahvistin



Suihkukomeron keskiosa



Seinän vahvistus on tarpeen

Tässä kohdassa seinää on vahvistettava



Koestusmerkki



Moduulien järjestys

Moduulien järjestys sovitetaan rakenteellisten vaatimusten mukaan.
(Asennusesimerkki katso s. 32 - s. 51.)

Kiinnitysmateriaali

Käytä vain seinän rakenteeseen soveltuvaa kiinnitysmateriaalia! Mukana olevat ruuvit ja kiinnitystulpat soveltuvat betoniin.

Huuhtelu

Huuhtele koko asennus DIN 1988 / EN 1717 mukaisesti.

Poistoteho

Poistovirtausteho on mitoitettava riittävän suureksi.

Vastaventtiili

Vastaventtiilien toiminta on tarkastettava säännöllisesti paikallisten ja kansallisten määräysten mukaisesti (DIN 1988, kerran vuodessa).



Tekniset tiedot

Käyttöpaine:	max. 1,0 MPa
Suosittelut käyttöpaine:	0,15 - 0,6 MPa
Koestuspaine:	1,6 MPa
Kuuman veden lämpötila:	max. 80° C
Kuuman veden suosituslämpötila:	65° C
Liittimet	G 3/4
Läpivirtausmäärä 0,3 MPa paineella:	
10750180 1 Kuluttaja	44 l/min
10750180 2 Kuluttaja	55 l/min
10650180	25 l/min
10971180	55 l/min
28486180	50 l/min



Sähköliitäntä

Tehonsyöttö 230V/N/PE/50Hz (pituus: 0,3 m) esiasennetaan.
Sähköasennuksessa on noudatettava voimassa olevia, asiaa koskevia VDE-, EVU- ja paikallisia määräyksiä.

Vikavirtasuojakytkin

Varmistus on tehtävä vikavirtasuojalaitetta (RCD/ FI), jonka vikavirta-asetus on ≤ 30 mA, käyttäen.



Monteringsverktyg/ Monteringsföljd



Måtten



Tekniska data



Hänvisning

Gör personalen uppmärksam på viktig information som måste beaktas.



Vattenanslutning

Varmvatten



Vattenanslutning

Kallvatten



Elinstallatör

Installations- och kontrollarbeten ska utföras av behörig elektroinstallatör, enligt VDE 0100 del 701 o. IEC 60364-7-701.

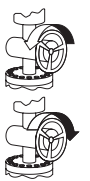

Vatten på / av



Monteringsföljd



Silikon (fri från ättiksyra!)



Plugga igen avlopp

Det utlopp som inte behövs måste tätas med en blindstopp.



Ledningsfall

Drag vattenledningar till sidoduschar med fall.



Ström på / av



Ihålligt rör EN20



PE Potentialutjämning

N Neutralledare

L Ledare

FI Jordfelsbrytare



Strömbrytare



Transformator



Glödlampa



Stickanslutning



Förstärkare till högtalare



Mitt i duschkabin



Väggförstärkning nödvändig

Šioje zonoje būtinas sienos sutvirtinimas



Testsigill



Modulernas placering

Anpassa modulernas placering till de förutsättningar som gäller på platsen. (Se sidan 32 till 51 för monteringsexempel.)

Monteringsmaterial

Endast passande monteringsmaterial får användas! Medföljande skruvar och plugg är endast avsedda för betong.

Spola

Spola igenom hela installationen enligt DIN 1988 / EN 1717.

Tömningskapacitet

Tömningskapaciteten måste vara tillräcklig.

Backventil

Backventilers funktion måste kontrolleras regelbundet enligt nationella eller regionala bestämmelser (DIN 1988 en gång per år) i enlighet med DIN EN 1717.



Tekniska data

Driftstryck:	max. 1,0 MPa
Rek. driftstryck:	0,15 - 0,6 MPa
Tryck vid provtryckning:	1,6 MPa
Varmvattentemperatur:	max. 80° C
Rek. varmvattentemp.:	65° C
Anslutningar	G 3/4
Flödeskapacitet vid 0,3 MPa:	
10750180 1 Förbrukare	44 l/min
10750180 2 Förbrukare	55 l/min
10650180	25 l/min
10971180	55 l/min
28486180	50 l/min



Elektrisk anslutning

Förinstallera strömförsörjning 230V/N/PE/50Hz (längd: 0,3 m).

Vid elinstallationen ska gällande föreskrifter från VDE [branchorganisation Verband der Elektrotechnik, Elektronik und Informationstechnik e.V.Bestimmungen], land- och EVU [elbolag- Elektrizitätsversorgungsunternehmen] i aktuell utgåva följas.

Felströms-skyddsanordning

Säkringen måste ske via en felströms-skyddsanordning (RCD/ FI) med en differensström på ≤ 30 mA.



Montavimo prietaisai/ Montavimo eiga



Išmatavimai



Techniniai duomenys



Nuoroda

Kai atitinkamas personalas nurodo informaciją, kurios turinys yra svarbus ir į jį būtina atkreipti dėmesį.



Vandens prijungimas

Šiltas vanduo



Vandens prijungimas

Šaltas vanduo



Elektromontuotojas

Instaliavimo ir tikrinimo darbus gali atlikti tik kvalifikuoti elektrikai pagal VDE 0100, 701 d. ir IEC 60364-7-701 standartų reikalavimus

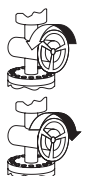

Vanduo įj./ išj.



Montavimo eiga



Silikonas (be acto rūgšties!)



Užkimšimas atliekomis

Nenaudojamą išėjimą užaklinti.



Slėgis vamzdyne

Privesti vamzdžius šoniniams purkštukams.

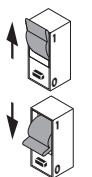

Srovė įj./ išj.



Tuščias vamzdelis EN20

PE Potencialų išlyginimas

N nulinis laidas

L laidas

FI FI apsauginis jungiklis



elektros jungiklis



Transformatorius



Šviesos šaltinis



kištukinės jungtys



Garsiakalbio stiprintuvas



Dušo kabinos vidurys



Būtinasis sienos sutvirtinimas

Šioje zonoje būtinas sienos sutvirtinimas



Bandymo pažyma



Modulių išdėstymas

Modulių išdėstymas pritaikomas prie esamų techninių sąlygų.
(Montavimo pavyzdžius žr. 32 - 51 psl.)

Tvirtinimo medžiaga

Gali būti naudojamos tik tam tinkamos tvirtinimo medžiagos! Komplektuojami varžtai ir kaištukai pritaikyti tik betonui.

Išplaukite

Išplaukite pagal DIN 1988 / EN 1717.

Išėjimo reikšmė

Vandens išleidimas privalo būti pakankamo dydžio.

atbulinis vožtuvas

Atbulinio vožtuvo apsauga privalo būti tikrinama reguliariai (mažiausiai kartą per metus pagal DIN 1988) pagal DIN EN1717 arba pagal galiojančias nacionalines arba regionines normas.



Techniniai duomenys

Darbinis slėgis:	max. 1,0 MPa
Rekomenduojamas slėgis:	0,15 - 0,6 MPa
Bandomasis slėgis:	1,6 MPa
Karšto vandens temperatūra:	max. 80° C
Rekomenduojama karšto vandens temperatūra:	65° C
Prijungimas	G 3/4
Vandens pralaidumas, esant 0,3 MPa slėgiui:	
10750180 1 Vartotojas	44 l/min
10750180 2 Vartotojas	55 l/min
10650180	25 l/min
10971180	55 l/min
28486180	50 l/min



Elektros prijungimas

Iš anksto įrengtas el. maitinimas 230V/N/PE/50Hz (ilgis 0,3 m).
Montuodami elektros įrangą, laikykitės galiojančių Vokietijos elektrotechnikos asociacijos (VDE), žemės ir - energijos tiekimo įmonės reikalavimų.

Apsaugos nuo gedimo prietaisai

Apsauginis įrenginys (RCD / FI) apsaugo nuo nebalanso srovės, kai srovių skirtumas ≤ 30 mA .



Alat za montažu/ Redosljed montažnih radova



Mjere



Tehnički podaci



Uputa

Odgovarajućem osoblju ukazuje na informacije čiji je sadržaj bitan i treba se uvažiti.



priključak na dovod vode

Topla voda



priključak na dovod vode

Hladna voda



elektroinstalater

Električne instalacijske i ispitne radove smiju obavljati samo certificirani električari uz uvažavanje odredaba VDE 0100 dio 701 i IEC 60364-7-701.

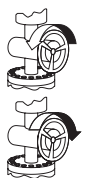

Voda uklj. / isklj.



Redosljed montažnih radova



Silikon (ne sadrži kiseline)



Odčepijavanje odvoda

Potrebno je ostaviti zatvoren izlaz koji se ne koristi



Nagib cijevi

Položite vodovodne cijevi za bočni tuš s nagibom



Struja uklj. / isklj.



Prazna cijev EN20



PE Izjednačenje potencijala

N Multi vodič

L Vodič

FI FI-sklopka



Prekidač za svjetlo



transformator



Rasvjetno tijelo



Utični spojevi



Pojačalo za zvučnik



Sredina kabine za tuširanje



neophodno ojačanje zida

U ovom je području potrebno ojačanje zida.



Oznaka testiranja



Raspored modula

Raspored modula prilagodite uvjetima koji vladaju na mjestu postavljanja. (Za primjere montaže vidi stranice 32 do 51.)

Pričvrсни materijal

Smije se koristiti samo prikladni pričvrсни materijal! Priloženi vijci i moždanici prikladni su samo za beton.

Ispiranje

Kompletnu instalaciju treba isprati sukladno DIN 1988 / EN 1717.

Protok vode

Potrebna je optimalan protok vode

nepovratni ventil

Ispravnost nepovratnog ventila mora se redovito provjeravati prema standardu DIN EN 1717 i u skladu sa važećim propisima (najmanje jednom godišnje).



Tehnički podaci

Najveći dopušteni tlak:	max. 1,0 MPa
Preporučeni tlak:	0,15 - 0,6 MPa
Probni tlak:	1,6 MPa
Temperatura vruće vode:	max. 80° C
Preporučena temperatura vruće vode:	65° C
Spojevi	G 3/4
Protok vode uz tlak od 0,3 MPa:	
10750180 1 Trošilo	44 l/min
10750180 2 Trošilo	55 l/min
10650180	25 l/min
10971180	55 l/min
28486180	50 l/min



Električni priključak

Prethodno instalirajte električno napajanje 230V/N/PE/50Hz (duljina 0,3 m). Prilikom provedbe električnih instalacijskih radova treba se pridržavati odgovarajućih, trenutno važećih propisa strukovne udruge elektrotehničara (u Njemačkoj: VDE), državnih propisa te propisa lokalnog poduzeća za distribuciju električne energije.

Nadstrujna zaštitna sklopka

Vod se mora osigurati nadstrujnom zaštitnom sklopkom (RCD/FI) s nazivnom diferencijalnom strujom ≤ 30 mA.



Montaj takımı/ Montaj sırası



Ölçüleri



Teknik bilgiler



Bilgi

İçeriği önem taşıyan ve dikkate alınması gereken bilgiler konusunda ilgili personelin dikkatini çeker.



Su bağlantısı

Sıcak su



Su bağlantısı

Soğuk su



Elektronik montajcısı

Kurulum ve kontrol çalışmaları, VDE 0100 Bölüm 701 ve IEC 60364-7-701'i dikkate almak suretiyle, elektronik konusunda uzman yetkili bir kişi tarafından gerçekleştirilmelidir.

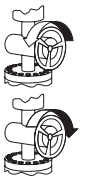

Su açık / kapalı



Montaj sırası



Silikon (asetik asit içermeyen)



Çıkışları kapatma

Kullanılmayan çıkış bir kör tapayla izole edilmelidir.



Hat eğimleri

Yan duşların su hatlarını eğimli şekilde döşeyin.



Akım açık / kapalı



Boş boru EN20



PE

Potansiyel dengelemesi

N

Sıfır iletken

L

İletken

FI

FI koruma şalteri



Işık şalteri



Trafo



Ampul



Soket bağlantıları



Hoparlör için güçlendirici



Duş kabininin ortası



Duvar takviyesi gereklidir

Bu alanda duvarın kalınlaştırılması gereklidir.



Kontrol işareti



Modüllerin düzeni

Modüllerin düzenini yapı özelliklerine uyarlayın. (Montaj örnekleri için bkz. Sayfa 32 ile Sayfa 51 arası.)

Tespit malzemesi

Sadece uygun sabitleme malzemesi kullanılmalıdır! Ekteki vidalar ve dübelller sadece beton için uygundur.

Yıkama

DIN 1988 / EN 1717'ye göre komple tesisatı yıkayın.

Çıkış gücü

Çıkış kapasitesi yeterli miktarda boyutlandırılmış olmalıdır.

Çek valf

DIN EN 1717 ve ulusal standartlar doğrultusunda Çek valfler düzenli olarak kontrol edilmelidir. (en az yılda bir kez)



Teknik bilgiler

İşletme basınca:	max. 1,0 MPa
Tavsiye edilen işletme basınca:	0,15 - 0,6 MPa
Kontrol basınca:	1,6 MPa
Sıcak su sıcaklığı:	max. 80° C
Tavsiye edilen su ısısı:	65° C
Bağlantılar	G 3/4
0,3 MPa'daki debi:	
10750180 1 Tüketici	44 l/min
10750180 2 Tüketici	55 l/min
10650180	25 l/min
10971180	55 l/min
28486180	50 l/min



Elektrik bağlantısı

Elektrik beslemesi 230V/N/PE/50Hz (Uzunluk: 0,3 m) ön montaj.
Elektrik montajı sırasında güncel sürümdeki ilgili VDE, ülke ve EVU talimatlarına uyulmalıdır.

Hatalı akım koruma donanımı

Emniyete alma, ≤ 30 mA ölçüm farkı akımı olan bir hatalı akım koruma tertibatı (RCD/FI) üzerinden gerçekleşmelidir.



Sculă pentru montaj/ Ordine de montare



Dimensiuni



Date tehnice



Observație

Atrageți atenția personalului asupra informațiilor importante și care trebuie respectate.



Racord de apă

Apă caldă



Racord de apă

Apă rece



Electrician

Lucrările de instalare și de verificare trebuie efectuate de către electricieni specializați, ținând cont de VDE 0100 Partea 701 și IEC 60364-7-701.

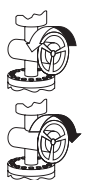

Apă pornită / oprită



Ordine de montare



Silicon (fără acid acetic!)



Astupați orificiile de evacuare

Racordurile neutilizate trebuie acoperite cu dop etanș.



Înălțimea de sarcină a conductei

Montați conductele de apă înclinate (în cădere) pentru dușurile laterale.

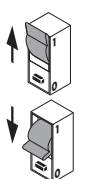

Curent pornit / oprit



Tub gol EN 20

PE Egalizare de potențial

N Fir neutru

L Conductor

FI Întreprător de protecție FI



Întreprător de lumină



Transformator



Lumină



Conexiuni



Amplificator pentru microfon



Mijlocul cabinei de duș



Este nevoie de consolidarea pereții.

În această zonă este nevoie de întărirea peretelui.



Certificat de testare



Poziția modulelor

Adaptați poziția modulelor condițiilor constructive.
(Exemplele de montaj vezi de la pag. 32 până la pag. 51.)

Material de fixare

Utilizați numai materiale de montare corespunzătoare! Șuruburile și diblurile livrate sunt potrivite pentru ziduri de beton.

Clătire

Clătiți toată instalația conform DIN 1988 / EN 1717.

Capacitate de evacuare

Debitul de golire trebuie să fie suficient de mare.

Supapă de rețineră

Supapele de reținere trebuie verificate regulat conform DIN EN 1717 și standardele naționale sau regionale (anual conform DIN 1988).



Date tehnice

Presiune de funcționare:	max. 1,0 MPa
Presiune de funcționare recomandată:	0,15 - 0,6 MPa
Presiune de verificare:	1,6 MPa
Temperatura apei calde:	max. 80° C
Temperatura recomandată a apei calde:	65° C
Racorduri	G 3/4
Debit de apă la 0,3 MPa:	
10750180 1 Consumator	44 l/min
10750180 2 Consumator	55 l/min
10650180	25 l/min
10971180	55 l/min
28486180	50 l/min



Conexiune electrică

Instalați în prealabil sistemul de alimentare cu curent 230V/N/PE/50Hz (lungime: 0,3 m). La montarea instalației electrice trebuie respectate prescripțiile VDE (Verband Deutscher Elektrotechniker = Asociația Electrotehnicienilor din Germania), prescripțiile din țara respectivă și prescripțiile EVU (Elektrizitäts-Versorgungs-Unternehmen = Într

Dispozitiv de protecție împotriva curentului rezidual

Instalația trebuie asigurată printr-un dispozitiv de protecție împotriva curentului rezidual (RCD/ FI) pentru curent rezidual măsurat de ≤ 30 mA.



**Εργαλεία συναρμολόγησης/
Σειρά εργασιών
συναρμολόγησης**



Διαστάσεις



Τεχνικά Χαρακτηριστικά



Σημείωση

Υποδεικνύει στο προσωπικό πληροφορίες με σημαντικό περιεχόμενο, που πρέπει να ληφθούν υπόψη.



Παροχή νερού

Ζεστό νερό



Παροχή νερού

Κρύο νερό



Ηλεκτρολόγος εγκατάστασης

Οι εργασίες εγκατάστασης και ελέγχου πρέπει να διενεργούνται από έναν εγκεκριμένο ηλεκτρολόγο, λαμβάνοντας υπόψη τις οδηγίες VDE 0100 Μέρος 701 και IEC 60364-7-701.

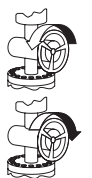

Νερό on / off



**Σειρά εργασιών
συναρμολόγησης**



Σιλικόνη (δίχως οξικό οξύ!)



Ταπώστε τις απορροές

Τα περιττά στόμια εξόδου πρέπει να στεγανοποιηθούν με ένα τυφλό πώμα.



Κλίση σωλήνα

Εγκαταστήστε τους αγωγούς νερού του καταιονιστήρα σώματος με κλίση.

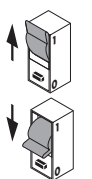

Ρεύμα on / off



Κενός σωλήνας EN20

PE Εξίσωση δυναμικού

N Ουδέτερος

L Αγωγός

FI Διακόπτης προστασίας FI



Διακόπτης φωτισμού



Trafo (μετασχηματιστής)



Φωτιστικό



Ηλεκτρικοί συνδετήρες



Ενισχυτής για μεγάφωνο



Μείση καμπίνας ντους



Απαραίτητη ενίσχυση τοίχου

Σε αυτήν την περιοχή είναι απαραίτητη μία ενίσχυση του τοίχου.



Σήμα ελέγχου



Διάταξη των στοιχείων

Προσαρμόστε τη διάταξη των στοιχείων στις επιτόπου συνθήκες (βλ. παραδείγματα συναρμολόγησης Σελίδα 32 έως Σελίδα 51.)

Υλικό στερέωσης

Επιτρέπεται η χρήση μόνο κατάλληλων υλικών σταθεροποίησης! Οι συνημμένες βίδες και στυλίσκοι είναι κατάλληλοι μόνο για σκυροκονίαμα (μπετόν).

Καθαρισμός

Καθαρισμός πλήρους εγκατάστασης σύμφωνα με το πρότυπο EN 1717.

Απόδοση απορροής

Η κατανάλωση νερού πρέπει να έχει επαρκείς διαστάσεις.

Βαλβίδα αντεπιστροφής

Οι βαλβίδες αντεπιστροφής πρέπει να ελέγχονται τακτικά ως προς τη λειτουργία τους, σύμφωνα με τις οδηγίες DIN EN 1717, σε σχέση με τους ισχύοντες εθνικούς ή τοπικούς κανόνες (το ελάχιστο μια φορά το χρόνο, σύμφωνα με το πρότυπο DIN 1988)



Τεχνικά Χαρακτηριστικά

Λειτουργία πίεσης:	max. 1,0 MPa
Συνιστώμενη λειτουργία πίεσης:	0,15 - 0,6 MPa
Πίεση ελέγχου:	1,6 MPa
Θερμοκρασία ζεστού νερού:	max. 80° C
Συνιστώμενη θερμοκρασία ζεστού νερού:	65° C
Συνδέσεις:	G 3/4
Κατανάλωση νερού στα 0,3 MPa:	
10750180 1 Κατανάλωση	44 l/min
10750180 2 Κατανάλωση	55 l/min
10650180	25 l/min
10971180	55 l/min
28486180	50 l/min



Ηλεκτρική παροχή

Προεγκατάσταση παροχής ρεύματος 230V/N/PE/50Hz (Μήκος: 0,3 m).

Στην ηλεκτρική εγκατάσταση πρέπει να τηρούνται οι αντίστοιχες προδιαγραφές της εκάστοτε ένωσης ηλεκτρολόγων, της εκάστοτε χώρας και εταιρείας ηλεκτρικού ρεύματος στην εκάστοτε έγκυρη έκδοση

Ρελέ προστασίας ρεύματος διαρροής

Η ασφάλιση θα πρέπει να πραγματοποιείται μέσω διάταξης προστασίας ρεύματος διαρροής (RCD/ FI) με παραμένον ρεύμα ≤ 30 mA.



Montažno orodje/ Montažno zaporedje



Mere



Tehnični podatki



Remarque

Opozaraja dotično osebje na informacije, katerih vsebina je pomembna in jo je treba upoštevati.



Vodni priključek

Topla voda



Vodni priključek

Mrzla voda



Elektroinštalater

Instalacijo in preizkuse mora izvesti pooblaščen elektro strokovnjak, pri čemer mora upoštevati VDE 0100 Del 701 in IEC 60364-7-701.

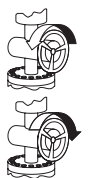

Voda odprta / zaprta



Montažno zaporedje



Silikon (brez ocetne kisline)



Odmašitev odvodov

Izhod, ki ga ne potrebujete, zatesnite s čepom.



Nagib vodovoda

Položite vodovodne cevi za stranske šobe z naklonom.

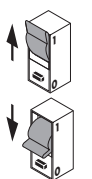

Tok vklop / izklop



Prazna cev EN20

PE Potencialna izenačitev

N Ničelni vodnik

L Vodnik

FI Zaščitno tokovno stikalo



Stikalo za luč



Trafo



Svetilo



Vtične povezave



Ojačevalnik za zvočnike



Sredina kabine za prho



Potrebno je ojačanje stene

V tem območju je potrebno ojačanje stene.



Preskusni znak



Razporeditev modulov

Razporeditev modulov priagodite gradbenim okoliščinam.
(Primere montaže glejte na straneh 32 do 51.)

Pritrditveni material

Uporabi se lahko le primeren pritrditveni material! Priloženi vijaki in mozniki so primerni le za beton.

Izpiranje

Kompletno instalacijo imperite v skladu z DIN 1988 / EN 1717.

Odtočna zmogljivost

Zmogljivost odtoka mora biti ustrezne velikosti.

Protipovratni ventil

Delovanje protipovratnega ventila je potrebno v skladu z DIN EN 1717 in skladno z državnimi in regionalnimi določili (DIN 1988 enkrat letno) redno testirati.



Tehnični podatki

Delovni tlak:	max. 1,0 MPa
Priporočeni delovni tlak:	0,15 - 0,6 MPa
Preskusni tlak:	1,6 MPa
Temperatura tople vode:	max. 80° C
Priporočena temperatura tople vode:	65° C
Priključki	G 3/4
Pretok vode pri 0,3 MPa:	
10750180 1 Porabnik	44 l/min
10750180 2 Porabnik	55 l/min
10650180	25 l/min
10971180	55 l/min
28486180	50 l/min



Električni priključek

Najprej instalirajte oskrbo s tokom 230V/N/PE/50Hz (dolžina: 0,3 m).
Pri električni instalaciji je treba upoštevati ustrezne VDE, nacionalne in EVU predpise v aktualno veljavni izdaji.

Zaščita pred okvarnim tokom

Zaščita se mora izvesti preko zaščitnega tokovnega stikala (RCD/ FI) z izračunanim diferenčnim tokom ≤ 30 mA.



**Monteerimistöriist/
Montaazijärjestus**



Mõõdude



Tehnilised andmed



Märkus

Juhtige asjasse puutuva personali tähelepanu teabele, mis on oluline ja mida tuleb järgida.



Veeühendus

Soe vesi



Veeühendus

Külm vesi



Elektrimontöör

Paigaldustööd ja kontroll laske viia läbi sertifitseeritud spetsialistil vastavalt VDE 0100 osa 701 ja IEC 60364-7-701 eeskirjadele.

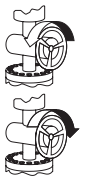

Vesi sees / väljas



Montaazijärjestus



Silikoon (äädikhappeta!)



Sulgege äravooluavad

Mittevajalik väljavool tuleb sulgeda korgiga.



Torustiku langus

Paigaldage kehaduši jaoks vajalikud veetorud kaldega.



Elektrivool sees / väljas



Paigaldustoru EN20



PE Potentsiaali tasakaalustamine

N neutraaljuhe

L juhe

FI kaitse



valgusüliti



transformaator



Valgusti



pistikühendused



Kõlarite võimendi



Dušikabiini keskkoh



Vajalik seinatugevdus

Selles alas tuleb seina tugevdada.



Kontrollsertifikaat



Moodulite paigaldus

Kohandage moodulite asendit paigaldusoludega sobivaks.
(Paigaldamisnäited lk 32 kuni 51.)

Kinnitusvahendid

Kasutage ainult sobivat kinnitusmaterjali! Kaasas olevad kruvid ja kinnitid sobivad vaid betoonile.

Äravoolu süsteem

Paigalduse lõpetamiseks uhuge läbi sooja ja külma vee varustus.

Äravooluvõimsus

Äravoolu jõudlus peab olema piisav.

tagasilöögiklapp

Tagasilöögiklappide toimimist tuleb kooskõlas riiklike ja regionaalsete määrustega regulaarselt kontrollida vastavalt standardile DIN EN 1717 (DIN 1988 - kord aastas).



Tehnilised andmed

Töörõhk	max. 1,0 MPa
Soovitatav töörõhk:	0,15 - 0,6 MPa
Kontrollsurve:	1,6 MPa
Kuuma vee temperatuur:	max. 80° C
Soovitatav kuuma vee temperatuur:	65° C
ühendused	G 3/4
Läbivool, kui rõhk on 0,3 MPa:	
10750180 1 Tarbija	44 l/min
10750180 2 Tarbija	55 l/min
10650180	25 l/min
10971180	55 l/min
28486180	50 l/min



Elektriühendus

Eelinstalleerige toide 230V/N/PE/50Hz (pikkus: 0,3 m).
Elektriinstallatsiooni juures tuleb järgida vastavaid Saksa elektrotehnikute liidu VDE, riiklike ja energiafirma eeskirju nende kehtivas versioonis.

Rikkevoolu kaitseeadis

Kaitse peab toimuma rikkevoolu kaitseeadisega (RCD/FI) nominaal-jääkvooluga ≤ 30 mA.



**Montāžas instruments/
Montāžas secība**



Izmērus



Tehniskie dati



Norāde

Atbilstošais personāls norāda uz informāciju, kuras saturs ir svarīgs un jāņem vērā.



Ūdensvada pieslēgvietā

Siltais ūdens



Ūdensvada pieslēgvietā

Aukstais ūdens



Elektromontieris

Instalācijas un pārbaudes darbus jāveic sertificētam speciālistam saskaņā ar DIN VDE 0100 701. d. un IEC 60364-7-701.

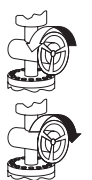

Ūdens padeve ieslēgta / izslēgta



Montāžas secība



Silikons (etiķskābi nesaturošs!)



Noslēdziet atveres

Neizmantojot izteku aizbāzīt ar aizbāzni.



Caurules kritums

Montēt ūdens cauruļvadus sānu (ķermeņa) dušām ar atbilstošu slīpumu.

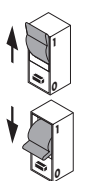

Strāva ieslēgta / izslēgta



Tukša caurule EN20

PE Potenciāla izlīdzināšana

N nulles vads

L vads

FI drošinātājs



gaismas slēdzis



Transformators



Apgaismes ķermeņis



spraudkontakti



Pastiprinātājs skaļrunim



Dušas kabīnes vidus



Nepieciešama sienas stiprināšana

Šajā zonā ir nepieciešams pastiprināt sienu.



Pārbaudes zīme



Moduļu izkārtojums

Moduļu izkārtojumu pielāgojiet ēkas apstākļiem. (Montāžas piemērus skatīt 32. līdz 51. lappusē.)

Nostiprināšanas materiāls

Drīkst izmantot tikai piemērotus stiprinājuma materiālus! Komplektā esošās skrūves un dibelji ir piemēroti tikai betonam.

Skalošana

Izskalojiet visu instalāciju atbilstoši DIN 1988 / NE 1717.

Aizplūdes iespējas

Noplūdei jānodrošina pietiekama ūdens caurplūde.

Pretvārsts

Regulāri jāpārbauda pretvārsta funkcija saskaņā ar DIN EN 1717 saistībā ar nacionālajiem vai vietējiem noteikumiem (DIN 1988 vienreiz gadā).



Tehniskie dati

Darba spiediens:	max. 1,0 MPa
Ieteicamais darba spiediens:	0,15 - 0,6 MPa
Pārbaudes spiediens:	1,6 MPa
Karstā ūdens temperatūra:	max. 80° C
Ieteicamā karstā ūdens temperatūra:	65° C
Pieslēgumi	G 3/4
Caurteces intensitāte pie 0,3 MPa:	
10750180 1 Patērētājs	44 l/min
10750180 2 Patērētājs	55 l/min
10650180	25 l/min
10971180	55 l/min
28486180	50 l/min



Elektroapgādes pieslēgvietā

Iepriekš instalējiet elektroapgādi 230V/N/PE/50Hz (garums: 0,3 m). Izveidojot elektroinstalāciju, jāņem vērā attiecīgie VDE (Vācijas elektrotehnikas savienības), valsts un energoapgādes uzņēmumu noteikumi attiecīgi spēkā esošajā redakcijā.

Drošinātājs

Jānodrošina noplūdes strāvas aizsargsistēma (RCD/ FI) ar izmērīto strāvas starpību ≤ 30 mA.



Montažni alat/ Redosled montažnih radova



Mere



Tehnički podaci



Napomena

Ukazuje odgovarajućem osoblju na informacije čiji je sadržaj važan i treba da se uvaži.



priključak za vodu

Topla voda



priključak za vodu

Hladna voda



elektroinstalater

Instalaciju i ispitivanje smeju obavljati isključivo sertifikovani električari uz uvažavanje odredaba VDE 0100 deo 701 i IEC 60364-7-701.

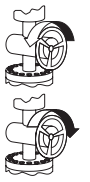

Voda uklj. / isklj.



Redosled montažnih radova



Silikon (ne sadrži sirćetnu kiselinu!)



Odčepljivanje odvoda

Izlaz koji se ne koristi, mora se zatvoriti slepim čepom.



Nagib cevi

Položite vodovodne cevi za bočni tuš s nagibom.



Struja uklj. / isklj.



Šuplja cev EN20

PE Izjednačenje potencijala

N Multi provodnik

L Provodnik

FI FI-sklopka



Prekidač za svetlo



transformator



Svetiljka



Utični spojevi



Pojačalo za zvučnik



Sredina kabine za tuširanje



neophodno ojačanje zida

U ovoj oblasti je potrebno ojačanje zida.



Ispitni znak



Raspored modula

Raspored modula prilagodite građevinskim uslovima na mestu postavljanja. (Za primere montaže vidi strane 32 do 51.)

Pričvrtni materijal

Sme se koristiti samo prikladni pričvrtni materijal! Priloženi vijci i tiplovi prikladni su samo za beton.

Ispiranje

Kompletnu instalaciju treba isprati u skladu s DIN 1988 / EN 1717.

Kapacitet odvoda

Mora se predvideti dovoljan kapacitet odvoda.

Nepovratni ventil

Ispravno funkcionisanje nepovratnog ventila se mora redovno proveravati prema standardu DIN EN 1717 i u skladu s važećim nacionalnim ili regionalnim propisima (DIN 1988 jednom godišnje).



Tehnički podaci

Radni pritisak:	max. 1,0 MPa
Preporučeni radni pritisak:	0,15 - 0,6 MPa
Probni pritisak:	1,6 MPa
Temperatura vruće vode:	max. 80° C
Preporučena temperatura vruće vode:	65° C
Priključci	G 3/4
Protok vode pri pritisku od 0,3 MPa:	
10750180 1 Potrošač	44 l/min
10750180 2 Potrošač	55 l/min
10650180	25 l/min
10971180	55 l/min
28486180	50 l/min



Električni priključak

Prethodno instalirajte električno napajanje 230V/N/PE/50Hz (dužina: 0,3 m). Prilikom izvođenja električnih instalacionih radova treba se pridržavati odgovarajućih, trenutno važećih propisa stručnog udruženja elektrotehničara (u Nemačkoj: VDE), državnih propisa kao i propisa lokalne elektro-distribucije.

Nadstrujna zaštitna sklopka

Vod se mora osigurati nadstrujnom zaštitnom sklopkom (RCD/FI) s nazivnom diferencijalnom strujom ≤ 30 mA.



Montasje verktøy/ Montasje rekkefølge



Mål



Tekniske data



Henvising

Gjør det respektive personalet oppmerksom på viktige informasjonen som skal overholdes.



Vanntilkobling

Varmtvann



Vanntilkobling

Kaldtvann



El-installatør

Installasjons- og kontrollarbeid skal utføres av en godkjent el-fagbedrift som overholder direktiv VDE 0100 del 701 og IEC 60364-7-70101.

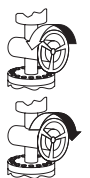

Vann på / av



Montasje rekkefølge



Silikon (uten eddiksyre)



Stoppe til avganger

Utgangen som ikke brukes kan tettes med en blindplugg.



Ledningsfall

Vannledning for sidedusjer installeres med fall.

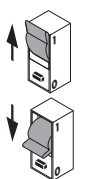

Strøm på / av



Tomrør EN20

PE Potensialutjevning

N Nulleleder

L Leder

FI FI-vernebryter



Lysbryter



Transformator



Lysmiddel



Pluggforbindelse



Forsterker for høyttaler



Midten av dusjkabinett



Veggforsterkning er nødvendig

I dette området skal veggen forsterkes.



Prøvemerket



El-tilkoblinger

Strømforsyning 230V/N/PE/Hz (lengde: 0,3 m) installeres på forhånd.

Ved el-installasjonen skal de tilsvarende gyldige VDE-, nasjonale og EVU-forskrifter overholdes.



Modulenes anordning

Modulenes anordning tilpasses omstendighetene (Monteringsseksempel se side 32 til side 51.)

Festematerial

Det skal kun brukes egnet festematerial. Medleverte skruer og plugg er egnet seg kun for betong.

Spyle

Komplett installasjon spyles iht. DIN 1988 / EN 1717.

Avløpskapasitet

Utløpsytelsen skal være tilstrekkelig dimensjonert.

Returløpssperre

Funksjonen til returløpssperren skal iht. DIN EN 1717 og i samsvar med de nasjonale og lokale forskrifter sjekkes regelmessig (DIN 1988 en gang i året).



Tekniske data

Driftstrykk	max. 1,0 MPa
Anbefalt driftstrykk:	0,15 - 0,6 MPa
Prøvetrykk	1,6 MPa
Varmtvannstemperatur	max. 80° C
Anbefalt temperatur for varmt vann	65° C
Tilkoblinger	G 3/4
Gjennomstrømningsytelse ved 0,3 MPa:	
10750180 1 Forbruker	44 l/min
10750180 2 Forbruker	55 l/min
10650180	25 l/min
10971180	55 l/min
28486180	50 l/min



**Монтажни инструменти/
Последователност на
монтажа**



Размери



Технически данни



Указание

Посочва на съответния персонал информации, чието съдържание е важно и трябва да бъде спазвано.



Извод за вода

Топла вода



Извод за вода

Студена вода



Електромонтьор

Дейностите по инсталацията и инспекцията следва да бъдат изпълнявани от оторизиран електротехник при спазване на VDE 0100 Част 701 и IEC 60364-7-701.

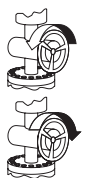

Вода вкл / изкл



**Последователност на
монтажа**



**Силикон (без оцетна
киселина!)**



Затапване на изводите

Излишният извод може да се уплътни с глуха пробка.



Наклон на тръбопровода

Водопроводните линии за страничните разпръскватели полагайте с наклон.

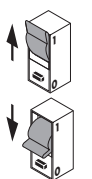

Електричество вкл / изкл



**Тръба за полагане на
кабели EN20**

PE Изравняване на потенциала

N Нулев проводник

L Проводник

**FI Защитен прекъсвач
погрешен ток**



Прекъсвач за осветлението



Трансформатор



Осветително тяло



Щепселни съединения



**Усилвател за
високоговорител**

X

Среда душкабина



**Необходимо е усиление на
стената**

В тази област е необходимо подсилване на стената.



Контролен знак



Свързване към електричеството

Захранване с ток 230V/N/PE/50Hz (дължина: 0,3 м).

При електроинсталацията трябва да се спазват съответните разпоредби на VDE (Съюз на електротехниците в Германия), на страната и на EVU (Съюз на електроснабдителните предприятия) в съответно валидната им редакция.

Предпазен шалтер за остатъчен ток

Защитата трябва да се осъществи с предпазен шалтер за остатъчен ток (RCD/ FI) с параметриран диференциален ток ≤ 30 mA.



Подреждане на модулите

Подреждането на модулите се изпълнява в съответствие с конструктивните дадености. (Примери за монтаж вижте на стр. 32 и стр. 51.)

Материал за закрепване

Позволено е единствено използване на подходящи материали за закрепване! Приложените винтове и дюбели са подходящи само за бетон.

Промиване

Промийте цялата инсталация съгласно DIN 1988 / EN 1717.

Мощност на изтичане

Трябва да се изчисли достатъчна мощност на изтичане.

**Приспособление, предотвратяващо
обратния поток**

Съгласно DIN EN 1717 редовно трябва да се проверява функционирането на приспособленията за предотвратяване на обратния поток в съответствие с националните или регионални изисквания (DIN 1988 веднъж годишно).



Технически данни

Работно налягане:	max. 1,0 MPa
Препоръчително работно налягане:	0,15 - 0,6 MPa
Контролно налягане:	1,6 MPa
Температура на горещата вода:	max. 80° C
Препоръчителна температура на горещата вода:	65° C
Изводи	G 3/4
Мощност на потока при 0,3 МПа:	
10750180 1 Консуматор	44 l/min
10750180 2 Консуматор	55 l/min
10650180	25 l/min
10971180	55 l/min
28486180	50 l/min



Vegla e montimit/ Radha e montimit



Përmasat



Të dhëna teknike



Udhëzim

Vini në dijeni personelin përkatës për informacionet, përmbajta e të cilave është e rëndësishme dhe që duhet ndjekur.



Lidhja me rrjetin e ujit

Uji i ngrohtë



Lidhja me rrjetin e ujit

Uji i ftohtë



Elektriciteti

Punimet e instalimit dhe të kontrollit duhet të realizohen nga një elektrikist i autorizuar duke marrë parasysh VDE 0100 Pjesa 701 dhe standardin IEC 60364-7-701.

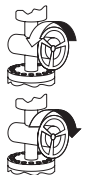

Uji hapur / mbyllur



Radha e montimit



Silikon (pa acid uthullet)



Blokimi i daljeve

Dalja që nuk nevojitet duhet izoluar me tapë qorre.



Pendeca e tubacionit

Vendosni tubacionet e ujit për spërkatëset anësore me pjerrësi.

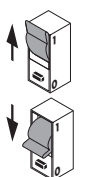

Korrenti kyçur / shkycur



Tubi i shtrimit EN20

PE Barazimi i potencialeve

N Lidhja neutrale

L Lidhje

FI Çelësi mbrojtës FI



Çelësi i dritës



Trafo



Ndriçuesi



Lidhjet e prizave



Përforcuesi për altoparantin



Mesi i kabinës së dushit



Nevojitet përforcimi i murit

Në këtë zonë është i nevojshëm një përforcim i murit.



Shenja e kontrollit



Vendosja e modulit

Përshtatni vendosjen e modulit sipas kushteve të ndërtimit.

(Për shembujt e montimit shikoni faqen 32 deri në faqen 51.)

Materiali i fiksimit

Guxohet të përdoret vetëm materiali i përshtatshëm për përforcim! Vidhat dhe kunjat prezent janë të përshtatshme vetëm për beton.

Shpëlarje

I gjithë instalimi duhet shpërlarë në bazë të normës DIN 1988 / EN 1717.

Shkarkimi në dalje

Kapaciteti i rrjedhjes duhet dimensionuar në mënyrë të mjaftueshme.

Penguesi i rrjedhjes në drejtim të kundërt

Penguesit e rrjedhjes në drejtim të kundërt duhen kontrolluar rregullisht në bazë të normave DIN EN 1717 konform normave nacionale dhe regjionale (DIN 1988 një herë në vit).



Të dhëna teknike

Presioni gjatë punës	max. 1,0 MPa
Presioni i rekomanduar:	0,15 - 0,6 MPa
Presioni për provë:	1,6 MPa
Temperatura e ujit të ngrohtë	max. 80° C
Temperatura e rekomanduar e ujit të ngrohtë:	65° C
Lidhjet	G 3/4
Kapaciteti i rrjedhjes në 0,3 MPa:	
10750180 1 Konsumator	44 l/min
10750180 2 Konsumator	55 l/min
10650180	25 l/min
10971180	55 l/min
28486180	50 l/min



Lidhja me rrjetin elektrik

Instaloni paraprakisht ushqimin elektrik 230V/N/PE/50Hz (gjatësia 0,3 m).

Gjatë instalimit elektrik duhen respektuar normat përkatëse të VDE-së, të shtetit dhe të EVU-së në verzionin e tyre aktual

Pajisja mbrojtëse kundër rrjedhjes së rrymës

Sigurimi duhet të kryhet nëpërmjet një pajisjeje mbrojtëse kundër rrjedhjes së rrymës (RCD/ FI) me një vlerësim të rrymës diferenciale ≤ 30mA.



معادلة الجهد الكهربائي

PE

أداة تركيب / ترتيب التركيب



الموصل المحايد

N

أبعاد

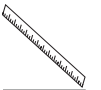

ترتيب الأنظمة

يجب ضبط ترتيب الأنظمة حسب معطيات البناء (أمثلة للتركيب تجدونها على الصفحات من 32 إلى 51)

المواصفات الفنية

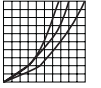

مفتاح حماية FI

FI

ملحوظة

تبيين للموظفين المختصين معلومات يجب الانتباه لمحتوياتها.



مواد تثبيت

يسمح باستخدام أدوات الربط المناسبة فقط! تتناسب المسامير اللولبية والسدادات المرفقة مع التثبيت في الخرسانة.

توصيلة مياه

ماء دافئ



نظام سريان الماء عبر المواسير

لإكمال التركيب، قم بفتح المياه الساخنة والباردة.

محول



توصيلة مياه

ماء بارد



قدرة تسيير

يجب أن يكون الأداء من حيث حجز الفضلات ذا حجم مناسب.

مادة إضاءة



توصيلات قابسية



مختص تركيب الإلكترونيات

يتعين القيام بكافة أعمال التركيب والفحص من قبل فني كهرباء معتمد مع الأخذ في الاعتبار الالتزام بالمعيار VDE 0100 الجزء 701 و IEC 60364-7-701.



صمام عدم الرجوع

يجب فحص صمام عدم الرجوع بصفة منتظمة حسب المواصفة DIN EN 1717 وذلك طبقاً للوائح الوطنية أو الإقليمية (مرة واحد سنوياً طبقاً للمواصفة DIN 1988).

مقوي ميكروفون



وسط كابينة الدوش

X

فتح / إغلاق المياه

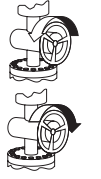

المنطقة الخاصة بالتدعيم المطلوب للجدار يلزم هذا في النطاق وجود تقوية للحائط.



شهادة اختبار



ترتيب التركيب



سيليكون (خالي من حمض الخليك!)



المواصفات الفنية

max. 1,0 MPa

0,15 - 0,6 MPa

1,6 MPa

max. 80° C

65° C

G 3/4

44 l/min

55 l/min

25 l/min

55 l/min

50 l/min

ضغط التشغيل:

ضغط التشغيل الموصى به:

ضغط الاختيار:

درجة حرارة الماء الساخن:

درجة الحرارة الموصى بها للماء الساخن:

الوصلات

محل التدفق عند ضغط 0,3 ميجاباسكال:

1 10750180 المستهلك

2 10750180 المستهلك

10650180

10971180

28486180



توصيلة كهربائية

ضبط إمداد الطاقة مقدماً

230V/N/PE/50Hz

(الطول 0,3 م)

يجب الالتزام بالقواعد السارية كل على حده عند عمل التركيبات الكهربائية،

وذلك بالنظر إلى قواعد إتحاد الصناعات الإلكترونية (VDE)، وقواعد الدولة، وقواعد الاتحاد الأوروبي لفحص وتحليل الحوادث (E.V.U.)

س المخارج

قم بسد المنفذ غير المستخدم.



مهبط توصيلة

قم بتركيب مواسير المياه للدش العادي المنحدر.



تشغيل / إيقاف الكهرباء

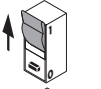

ماسورة فراغة EN20



مد طاقة خاطئ - تجهيزة حماية

يتم التأمين من خلال تجهيزة حماية ضد اختلاف التيار (RCD/ FI) عند اختلاف التيار لأقل من أو يساوي 30 مللي أمبير.

10754180

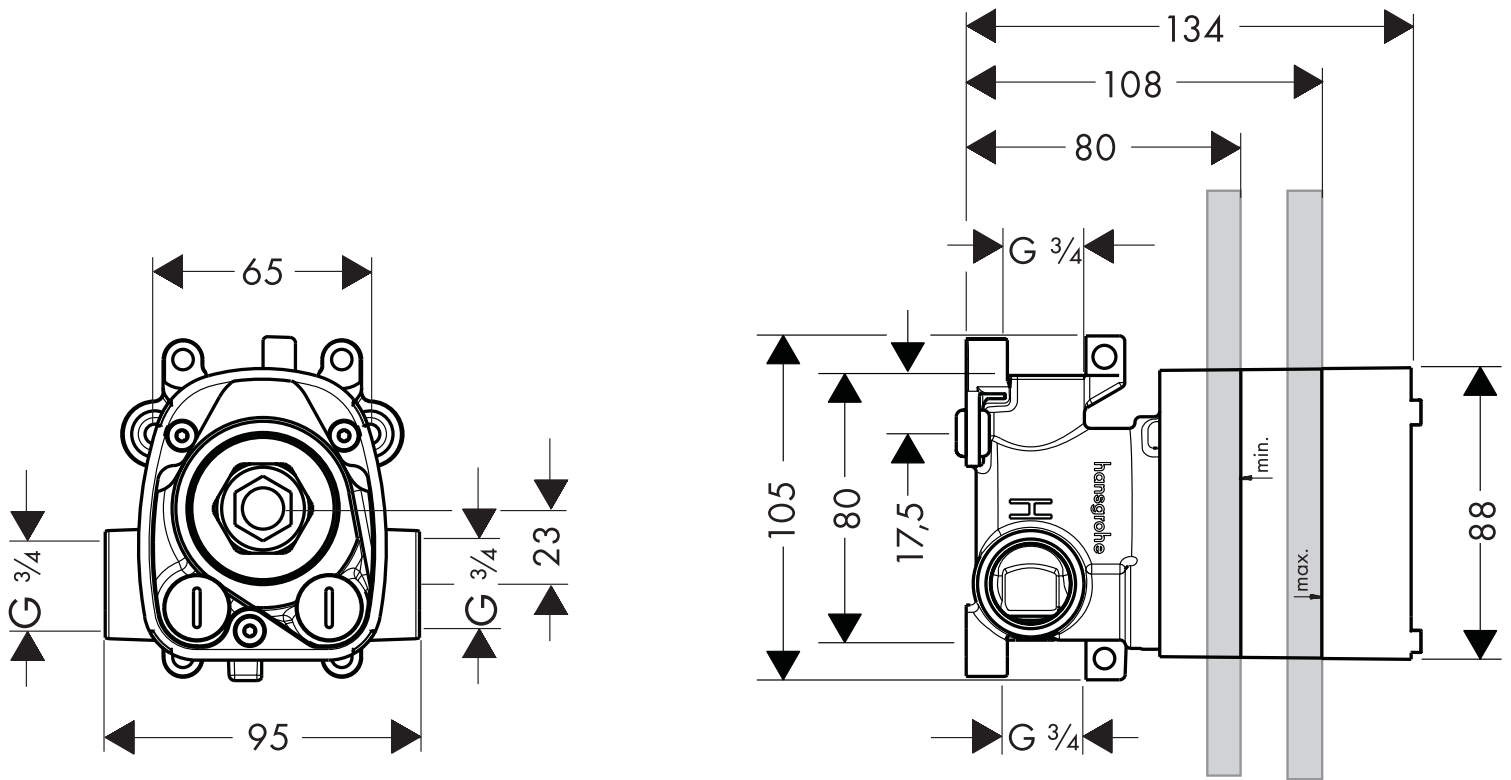

	P-IX	DVGW	SVGW	ACS	WRAS	ETA	KIWA
10754180			X	X	X		

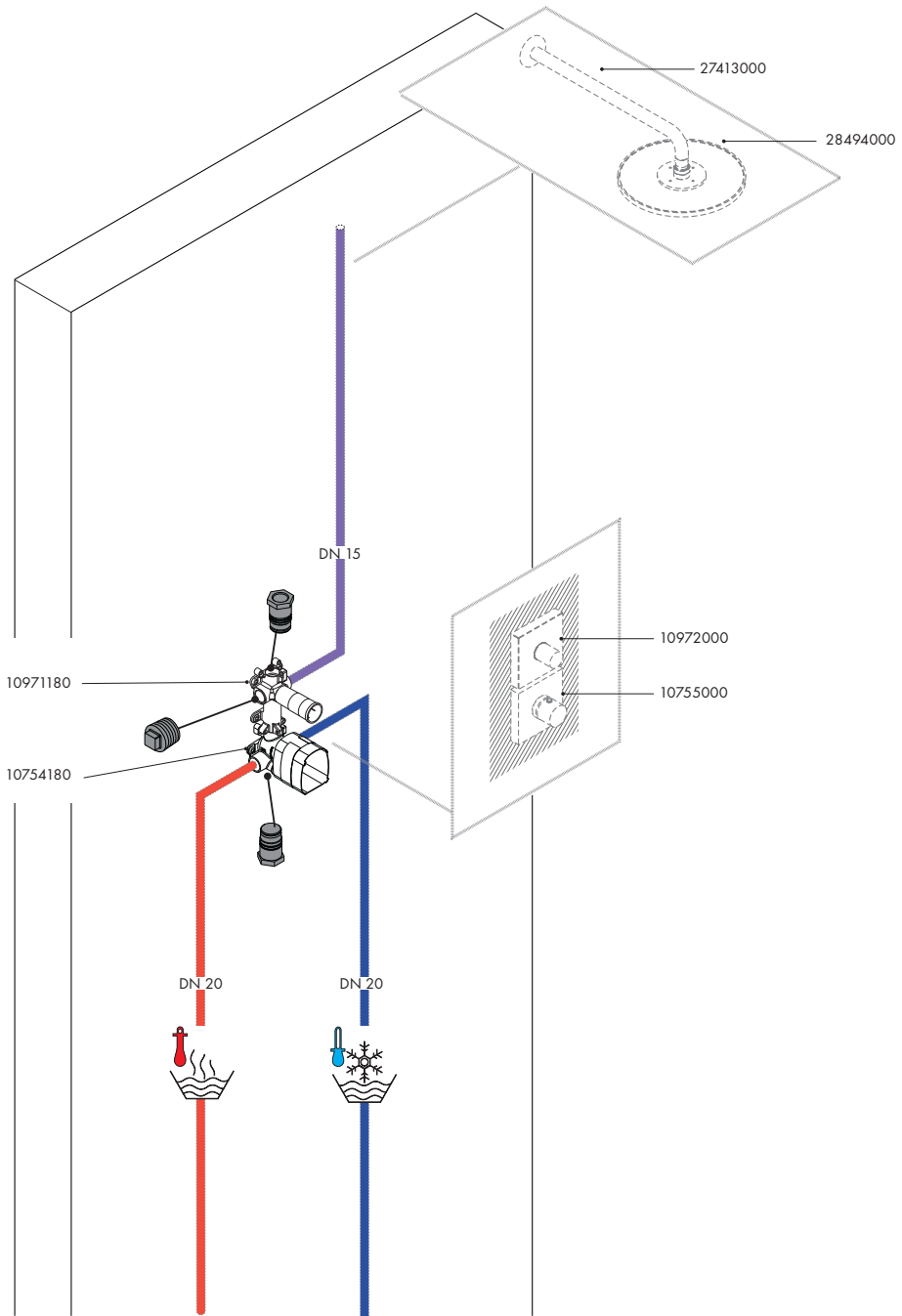

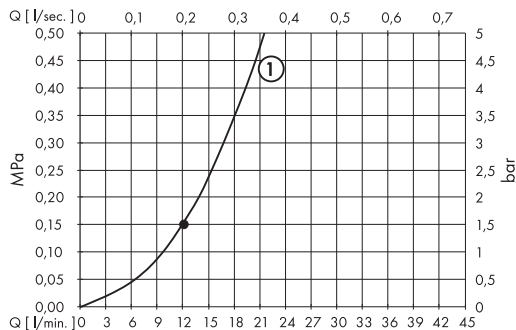

- DE** Ab • ist die Funktion gewährleistet.
FR A partir de • le fonctionnement est garanti.
EN From • the function is guaranteed.
IT Dal • si garantisce la funzionalità.
ES Mínimo • para el correcto funcionamiento.
NL Vanaf • is het functioneren gegarandeerd.
DK Fra • er funktionen anvendelig.
PT • A partir deste ponto inicia-se o funcionamento correcto.
PL Od • możliwe jest funkcjonowanie.
CS „Od • je zaručená funkce.”
SK Od • je zaručená funkcia.
ZH 从 • 开始，正常功能得以保证。

RU Гарантированное функционирование при показателях выше • .

HU A • -ól működik az adott funkció.

FI Tästä toiminta on taattu • alkaen.

SV Från • garanteras funktionen.

LT Nuo • funkcionavimas garantuotas

HR Zajamčena funkcija od • navise

TR •'den itibaren fonksiyon garanti edilmektedir.

RO Începând de la • funcționarea este garantată.

EL Αυτή η λειτουργία διασφαλίζεται από το σημείο κι έπειτα

SL Od • je delovanje zagotovljeno.

ET Alates • on funktsioneerimine garanteeritud

LV No • funkcija nodrošināta

SR Od • je funkcija zagarantovana.

NO F.o.m. • er funksjonen garantert

BG От • функцията е гарантирана.

SQ Nga • është i mundur funksioni.

AR من • ووضوح تفسي طولاً ن م

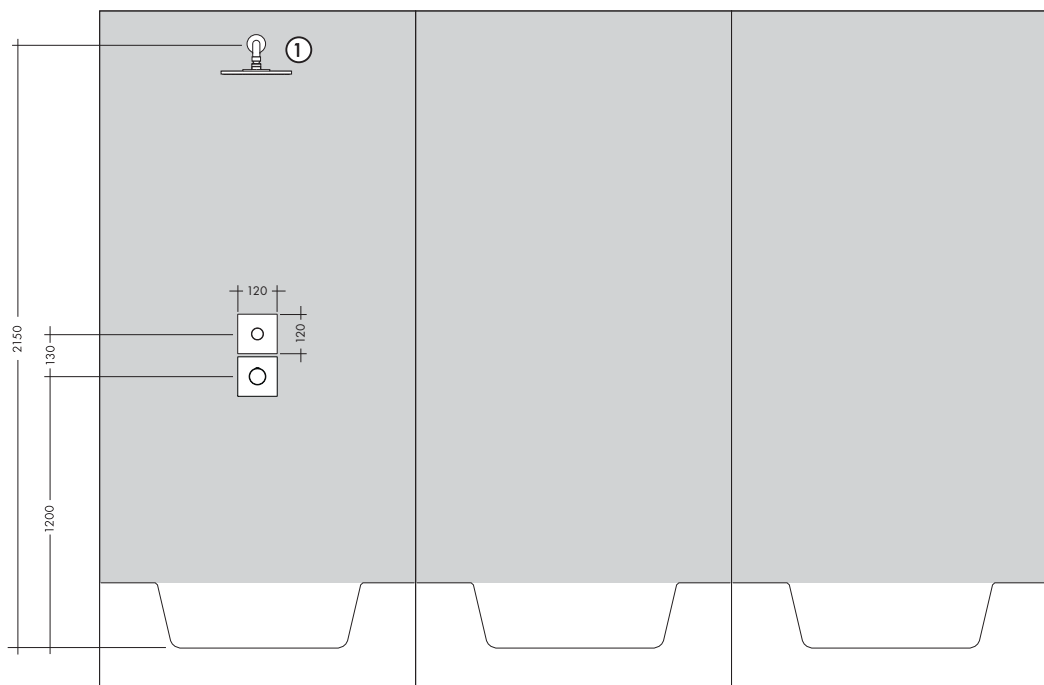

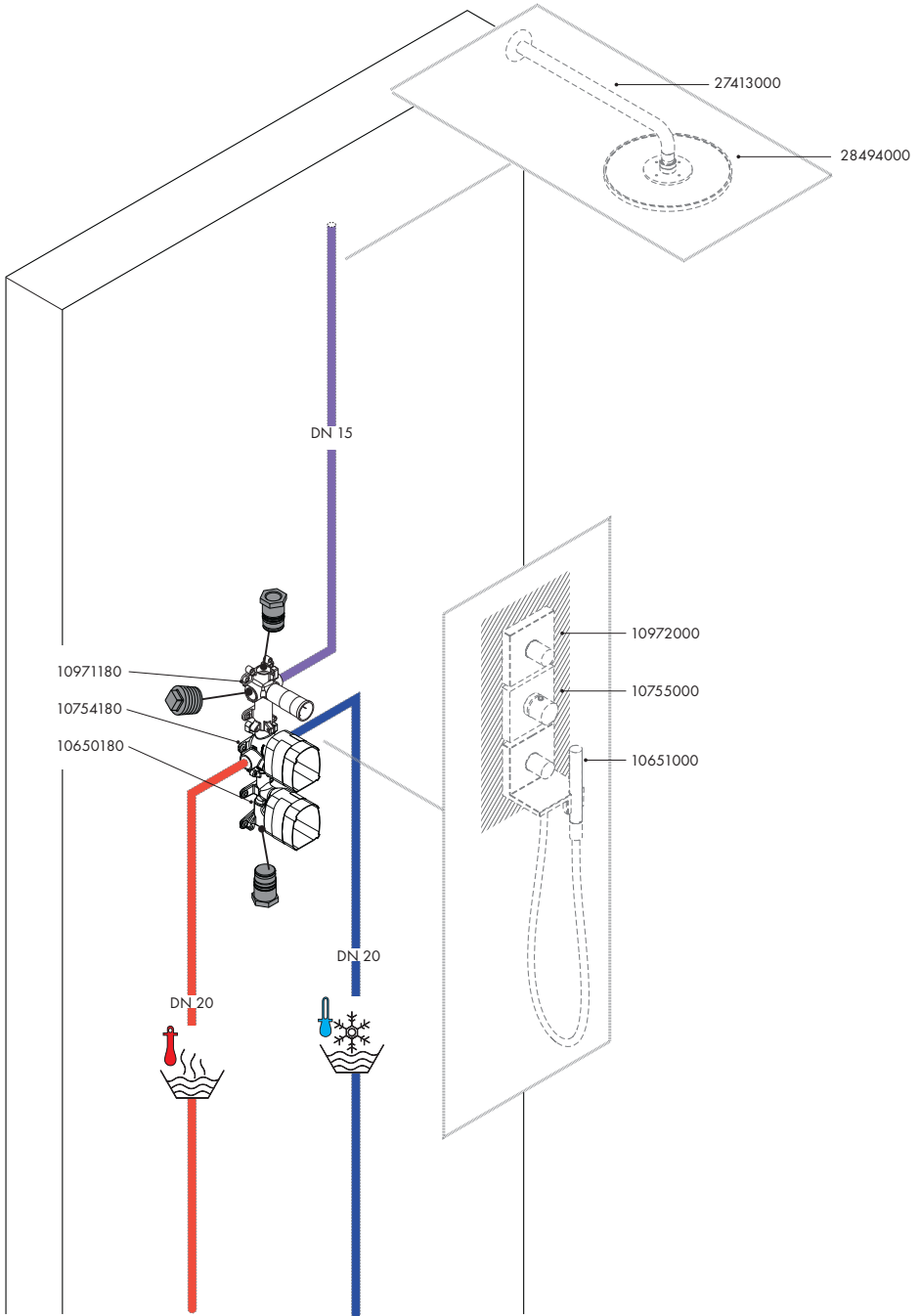

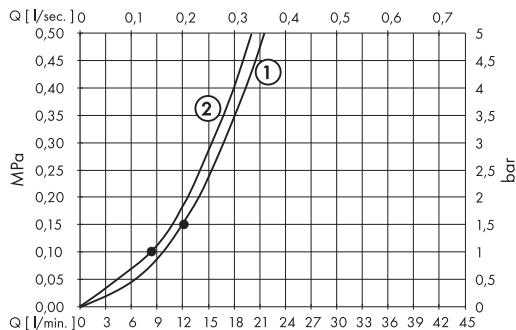

RU Гарантированное функционирование при показателях выше •.

HU A • -ól működik az adott funkció.

FI Tämä toiminta on taattu • alkaen.

SV Från • garanteras funktionen.

LT Nuo • funkcionavimas garantuotas

HR Zajamčena funkcija od • navise

TR •'den itibaren fonksiyon garanti edilmiştir.

RO Încercând de la • funcționarea este garantată.

EL Αυτή η λειτουργία διασφαλίζεται από το σημείο κι έπειτα

SL Od • je delovanje zagotovljeno.

DE Ab • ist die Funktion gewährleistet.

FR A partir de • le fonctionnement est garanti.

EN From • the function is guaranteed.

IT Dal • si garantisce la funzionalità.

ES Mínimo • para el correcto funcionamiento.

NL Vanaf • is het functioneren gegarandeerd.

DK Fra • er funktionen anvendelig.

PT • A partir deste ponto inicia-se o funcionamento correcto.

PL Od • możliwe jest funkcjonowanie.

CS „Od • je zaručená funkce„

SK Od • je zaručená funkcia.

ZH 从 • 开始，正常功能得以保证。

ET Alates • on funktsioneerimine garanteeritud

LV No • funkcija nodrošināta

SR Od • je funkcija zagarantovana.

NO F.o.m. • er funksjonen garantert

BG От • функцията е гарантирана.

SQ Nga • është i mundur funksioni.

AR من • ووضم تفسي طولاً • نم

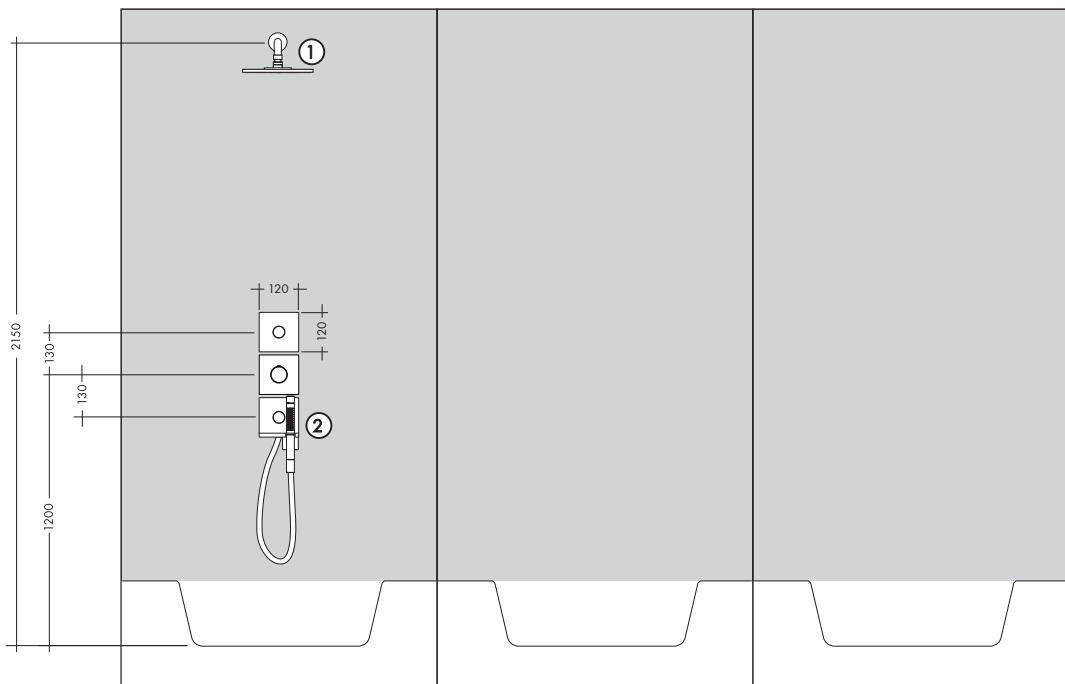

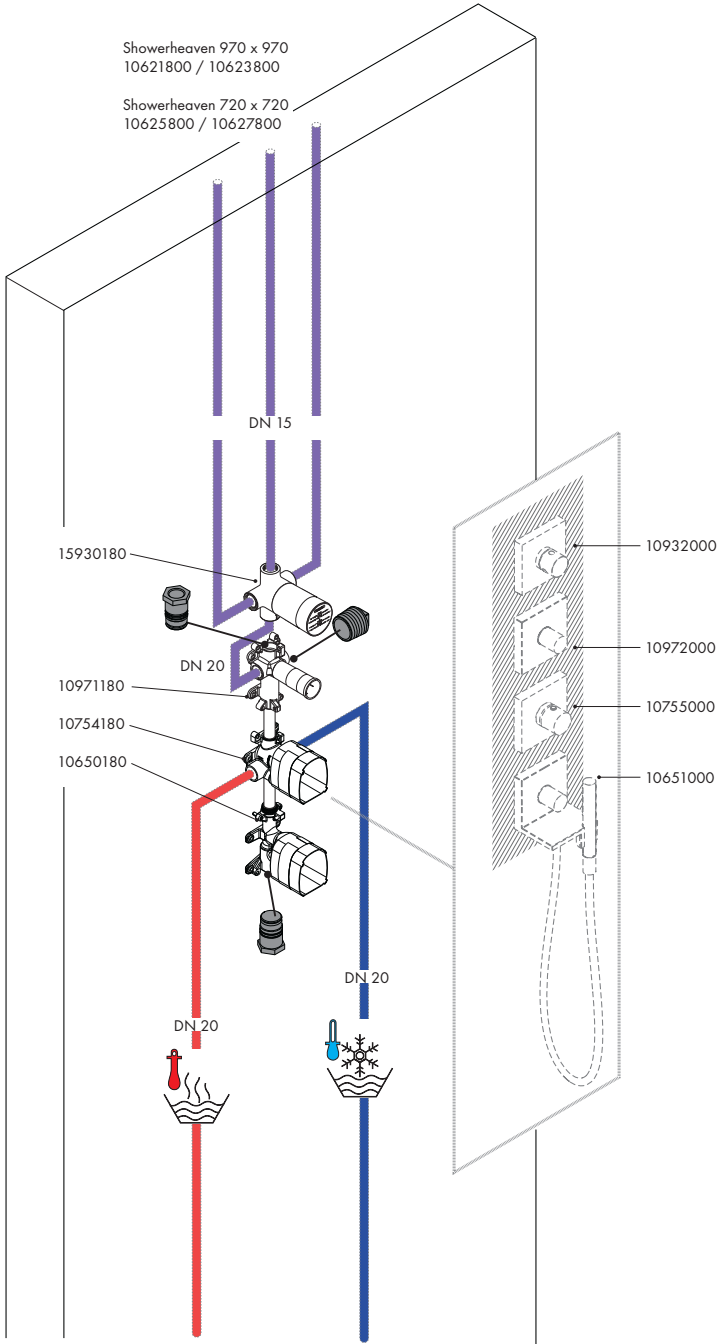

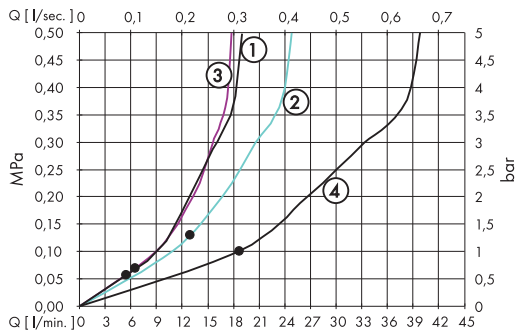

- DE** Ab • ist die Funktion gewährleistet.
- FR** A partir de • le fonctionnement est garanti.
- EN** From • the function is guaranteed.
- IT** Dal • si garantisce la funzionalità.
- ES** Mínimo • para el correcto funcionamiento.
- NL** Vanaf • is het functioneren gegarandeerd.
- DK** Fra • er funktionen anvendelig.
- PT** • A partir deste ponto inicia-se o funcionamento correcto.
- PL** Od • możliwe jest funkcjonowanie.
- CS** „Od • je zaručená funkce„
- SK** Od • je zaručená funkcia.
- ZH** 从 • 开始，正常功能得以保证。

RU Гарантированное функционирование при показателях выше •.

HU A • -ól működik az adott funkció.

FI Tämä toiminta on taattu • alkaen.

SV Från • garanteras funktionen.

LT Nuo • funkcionavimas garantuotas

HR Zajamčena funkcija od • navise

TR •'den itibaren fonksiyon garanti edilmiştir.

RO Începând de la • funcționarea este garantată.

EL Αυτή η λειτουργία διασφαλίζεται από το σημείο κι έπειτα

SL Od • je delovanje zagotovljeno.

ET Alates • on funktsioneerimine garanteeritud

LV No • funkcija nodrošināta

SR Od • je funkcija zagarantovana.

NO F.o.m. • er funksjonen garantert

BG От • функцията е гарантирана.

SQ Nga • është i mundur funksioni.

AR من ووضوح تفسي طولاً • ن م

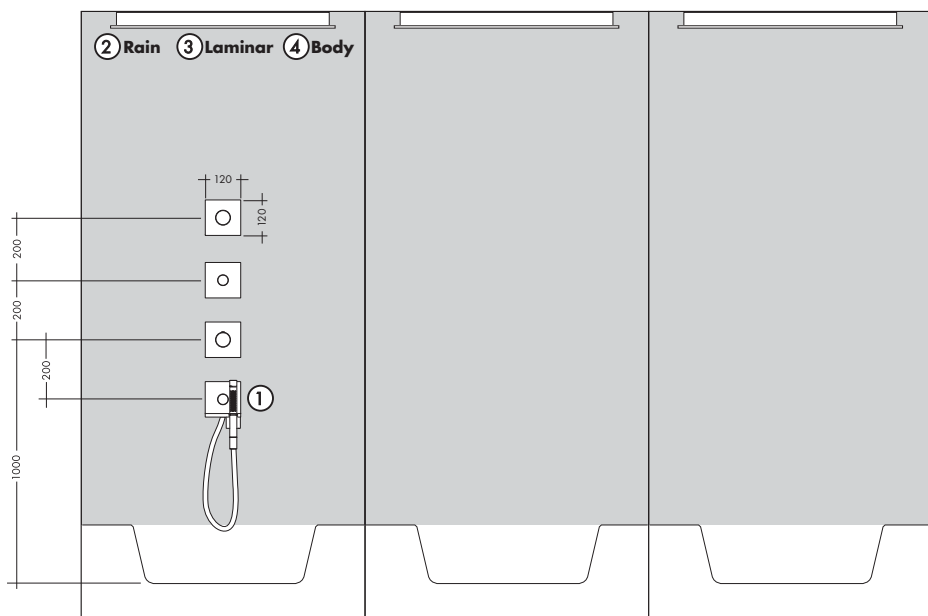

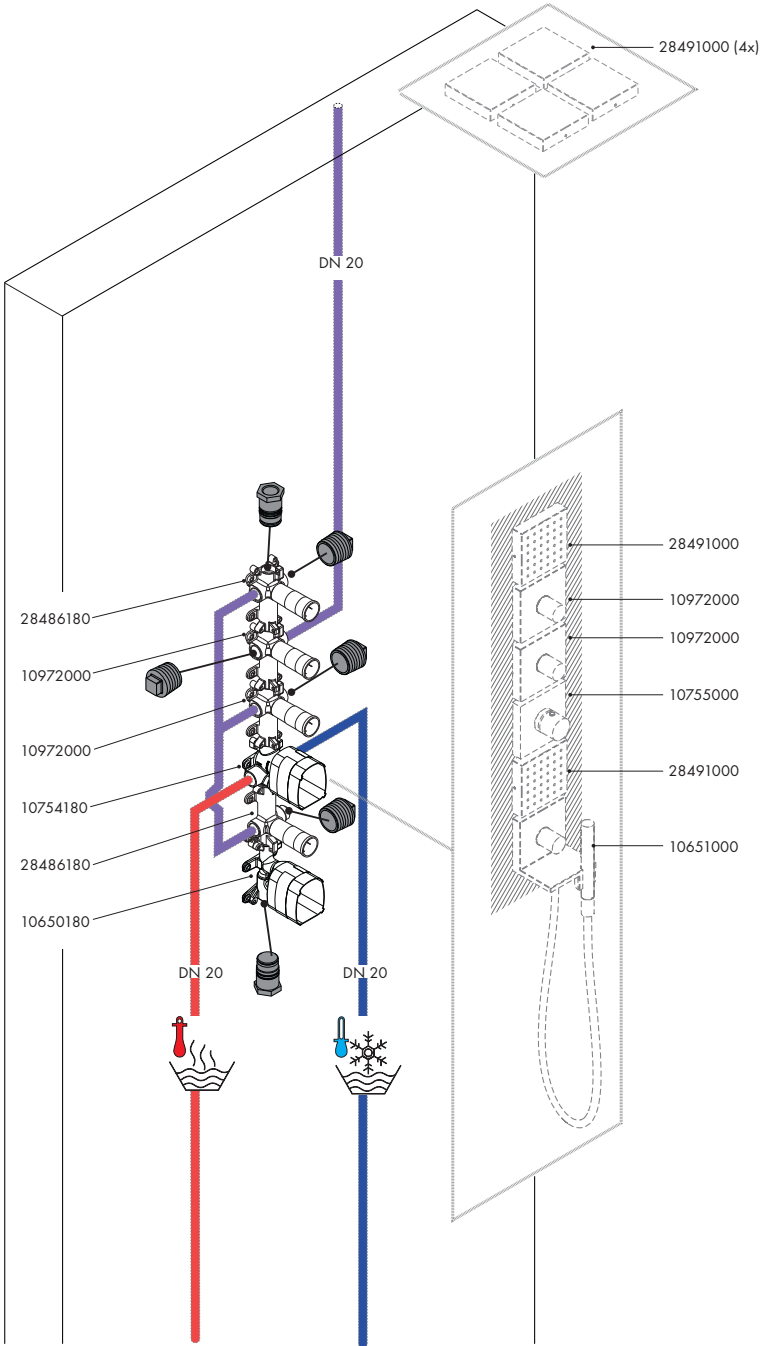

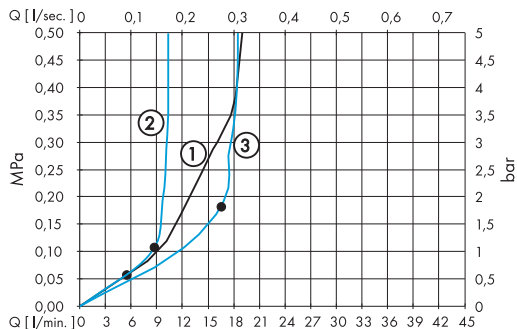

- DE** Ab • ist die Funktion gewährleistet.
FR A partir de • le fonctionnement est garanti.
EN From • the function is guaranteed.
IT Dal • si garantisce la funzionalità.
ES Mínimo • para el correcto funcionamiento.
NL Vanaf • is het functioneren gegarandeerd.
DK Fra • er funktionen anvendelig.
PT • A partir deste ponto inicia-se o funcionamento correcto.
PL Od • możliwe jest funkcjonowanie.
CS „Od • je zaručená funkce.”
SK Od • je zaručená funkcia.
ZH 从 • 开始，正常功能得以保证。

RU Гарантированное функционирование при показателях выше •.

HU A • föl működik az adott funkció.

FI Tämä toiminta on taattu • alkaen.

SV Från • garanteras funktionen.

LT Nuo • funkcionavimas garantuotas

HR Zajamčena funkcija od • navise

TR •'den itibaren fonksiyon garanti edilmektedir.

RO Începând de la • funcționarea este garantată.

EL Αυτή η λειτουργία διασφαλίζεται από το σημείο κι έπειτα

SL Od • je delovanje zagotovljeno.

ET Alates • on funktsioneerimine garanteeritud

LV No • funkcija nodrošināta

SR Od • je funkcija zagarantovana.

NO F.o.m. • er funksjonen garantert

BG От • функцията е гарантирана.

SQ Nga • është i mundur funksioni.

AR من ووضم نفسي طولاً • ن م

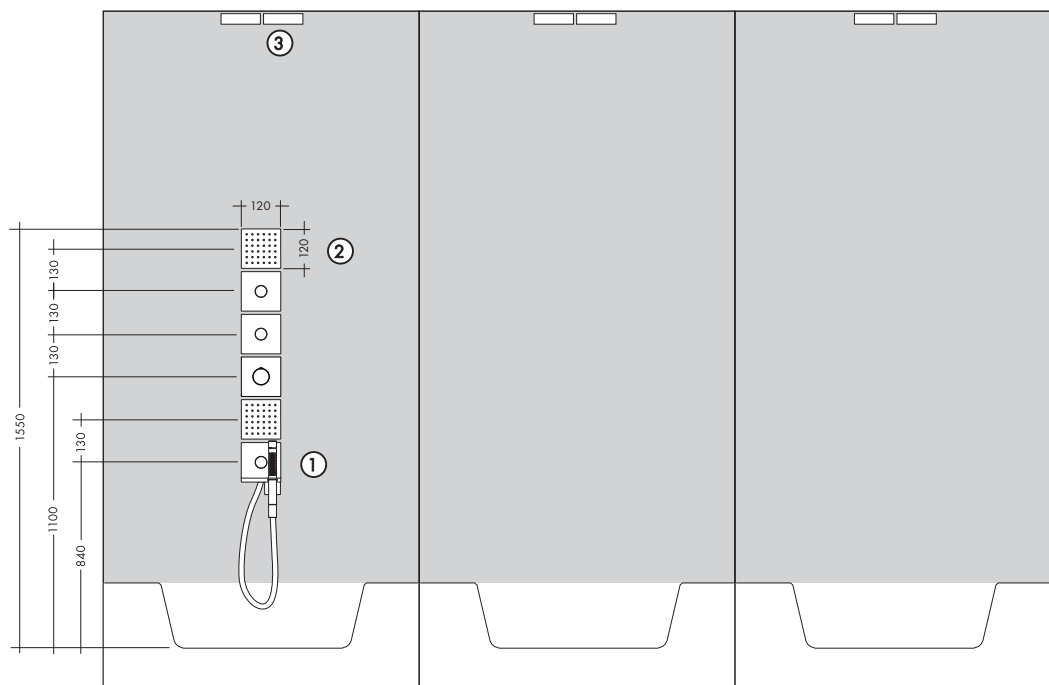

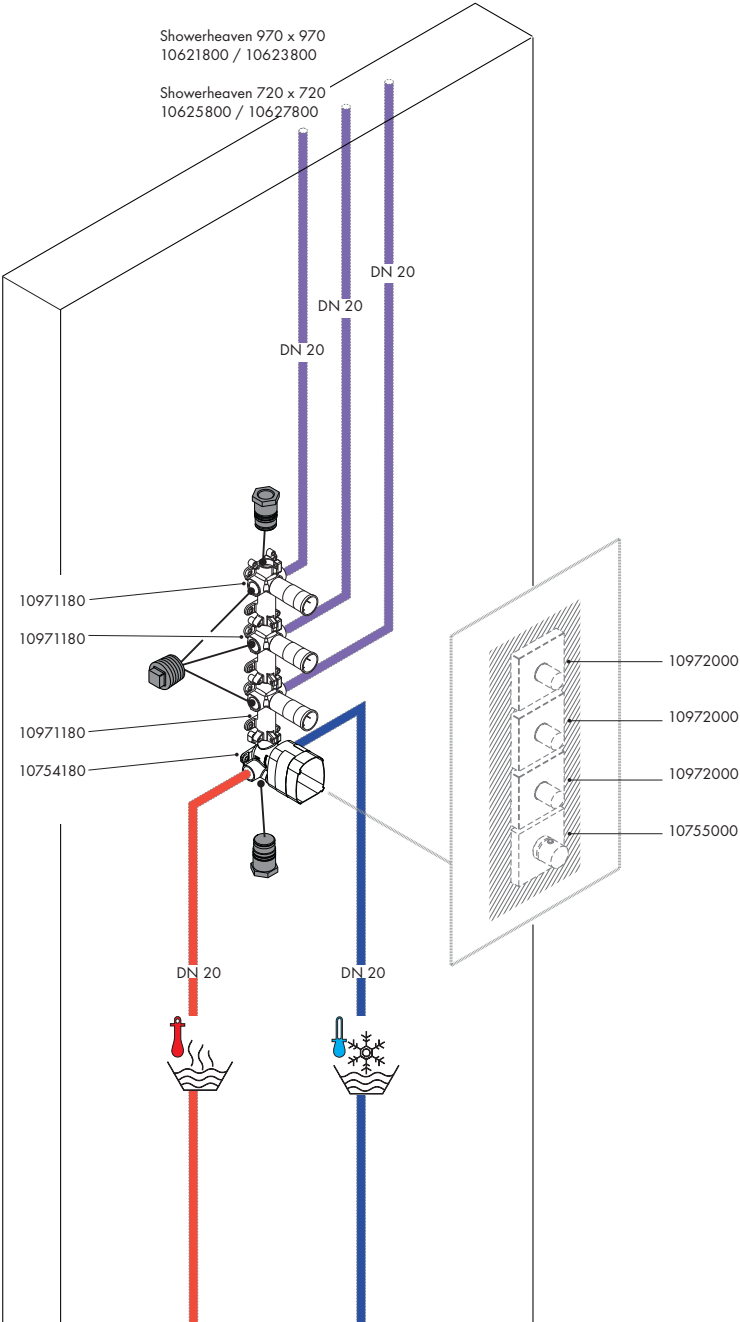

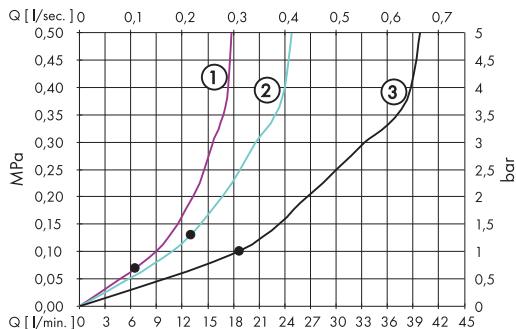

- DE** Ab • ist die Funktion gewährleistet.
- FR** A partir de • le fonctionnement est garanti.
- EN** From • the function is guaranteed.
- IT** Dal • si garantisce la funzionalità.
- ES** Mínimo • para el correcto funcionamiento.
- NL** Vanaf • is het functioneren gegarandeerd.
- DK** Fra • er funktionen anvendelig.
- PT** • A partir deste ponto inicia-se o funcionamento correcto.
- PL** Od • możliwe jest funkcjonowanie.
- CS** „Od • je zaručená funkce„
- SK** Od • je zaručená funkcia.
- ZH** 从 • 开始，正常功能得以保证。

RU Гарантированное функционирование при показателях выше •.

HU A • föl működik az adott funkció.

FI Tämä toiminta on taattu • alkaen.

SV Från • garanteras funktionen.

LT Nuo • funkcionavimas garantuotas

HR Zajamčena funkcija od • navise

TR •'den itibaren fonksiyon garanti edilmektedir.

RO Începând de la • funcționarea este garantată.

EL Αυτή η λειτουργία διασφαλίζεται από το σημείο κι έπειτα

SL Od • je delovanje zagotovljeno.

ET Alates • on funktsioneerimine garanteeritud

LV No • funkcija nodrošināta

SR Od • je funkcija zagarantovana.

NO F.o.m. • er funksjonen garantert

BG От • функцията е гарантирана.

SQ Nga • është i mundur funksioni.

AR من ووضم تفسي طولاً • ن م

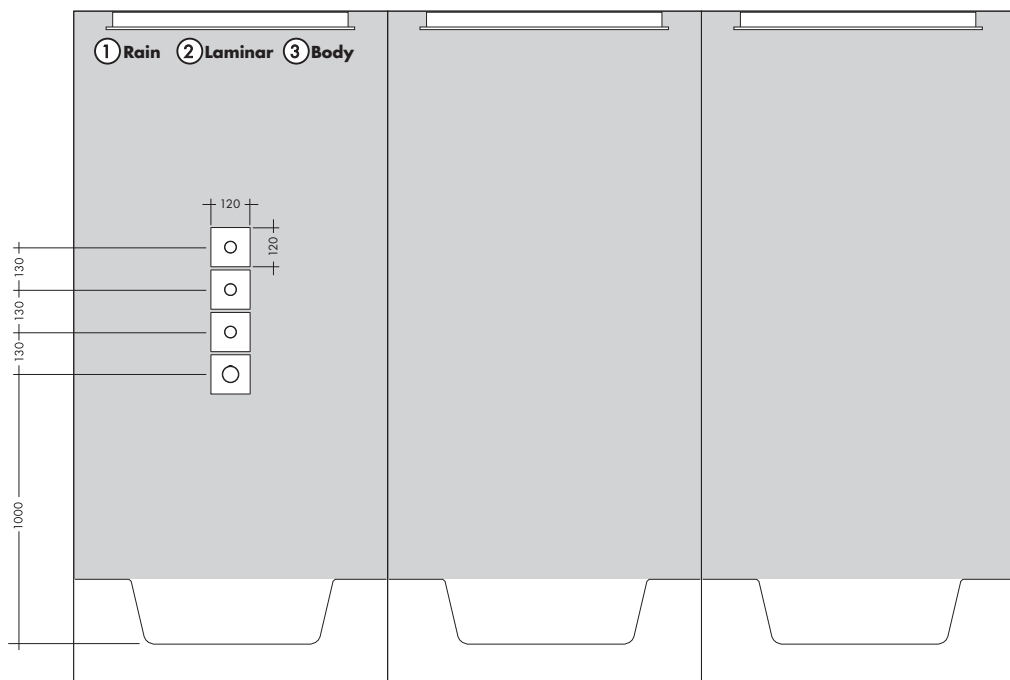

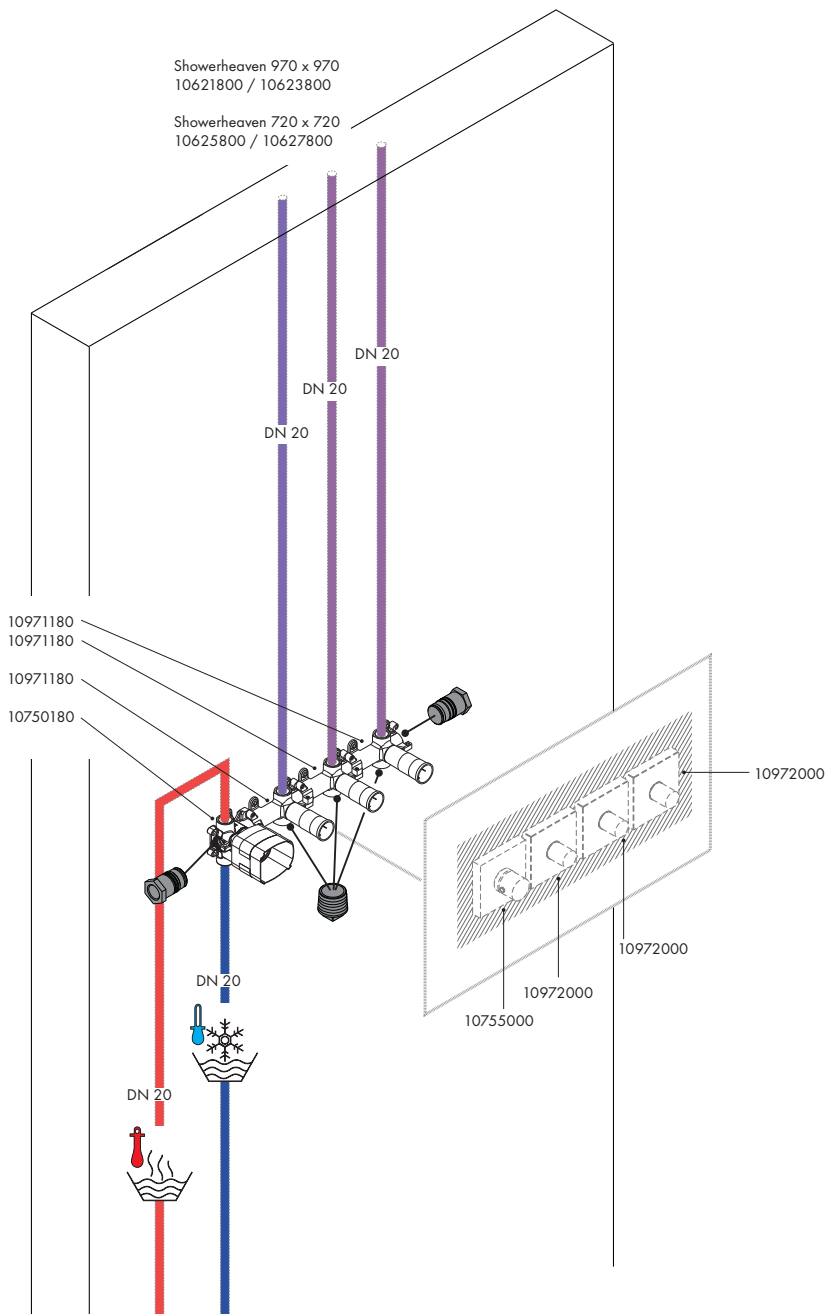

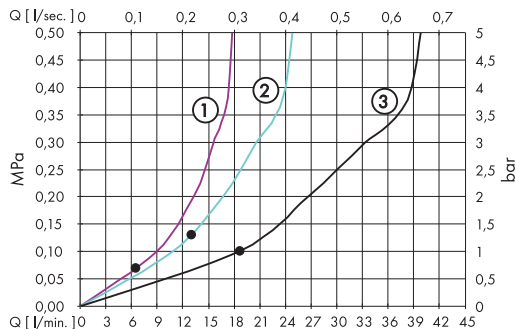

- DE** Ab • ist die Funktion gewährleistet.
- FR** A partir de • le fonctionnement est garanti.
- EN** From • the function is guaranteed.
- IT** Dal • si garantisce la funzionalità.
- ES** Mínimo • para el correcto funcionamiento.
- NL** Vanaf • is het functioneren gegarandeerd.
- DK** Fra • er funktionen anvendelig.
- PT** • A partir deste ponto inicia-se o funcionamento correcto.
- PL** Od • możliwe jest funkcjonowanie.
- CS** „Od • je zaručená funkce„
- SK** Od • je zaručená funkcia.
- ZH** 从 • 开始，正常功能得以保证。

RU Гарантированное функционирование при показателях выше •.

HU A • -ól működik az adott funkció.

FI Tämä toiminta on taattu • alkaen.

SV Från • garanteras funktionen.

LT Nuo • funkciovimas garantuotas

HR Zajamčena funkcija od • navise

TR •'den itibaren fonksiyon garanti edilmiştir.

RO Începând de la • funcționarea este garantată.

EL Αυτή η λειτουργία διασφαλίζεται από το σημείο κι έπειτα

SL Od • je delovanje zagotovljeno.

ET Alates • on funktsioneerimine garanteeritud

LV No • funkcija nodrošināta

SR Od • je funkcija zagarantovana.

NO F.o.m. • er funksjonen garantert

BG От • функцията е гарантирана.

SQ Nga • është i mundur funksioni.

AR من ووضم تفسي طولاً • ن م

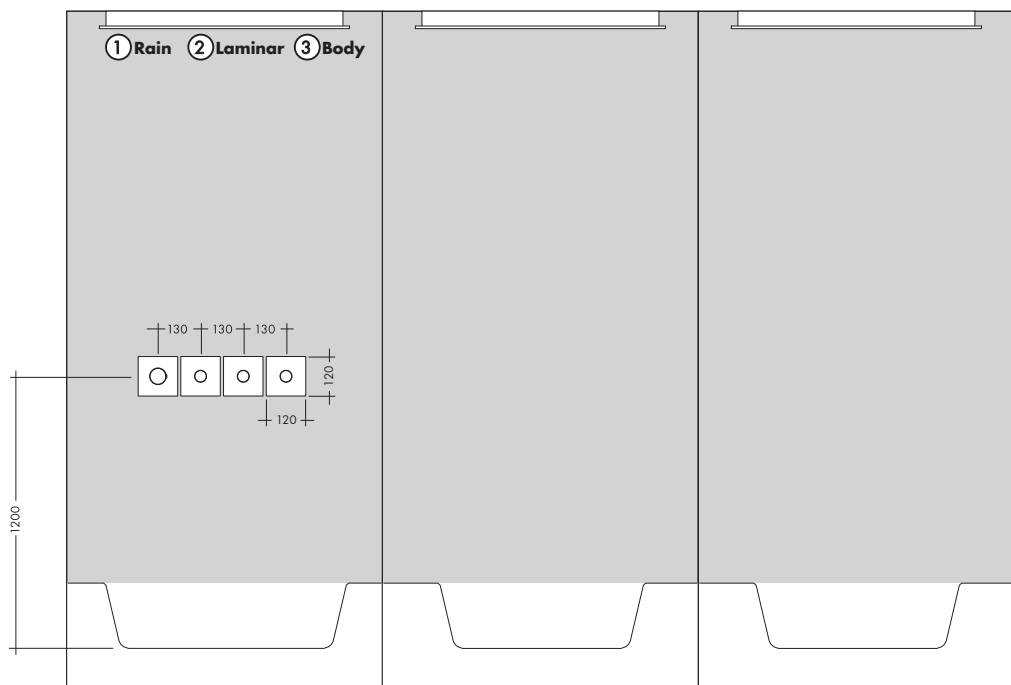

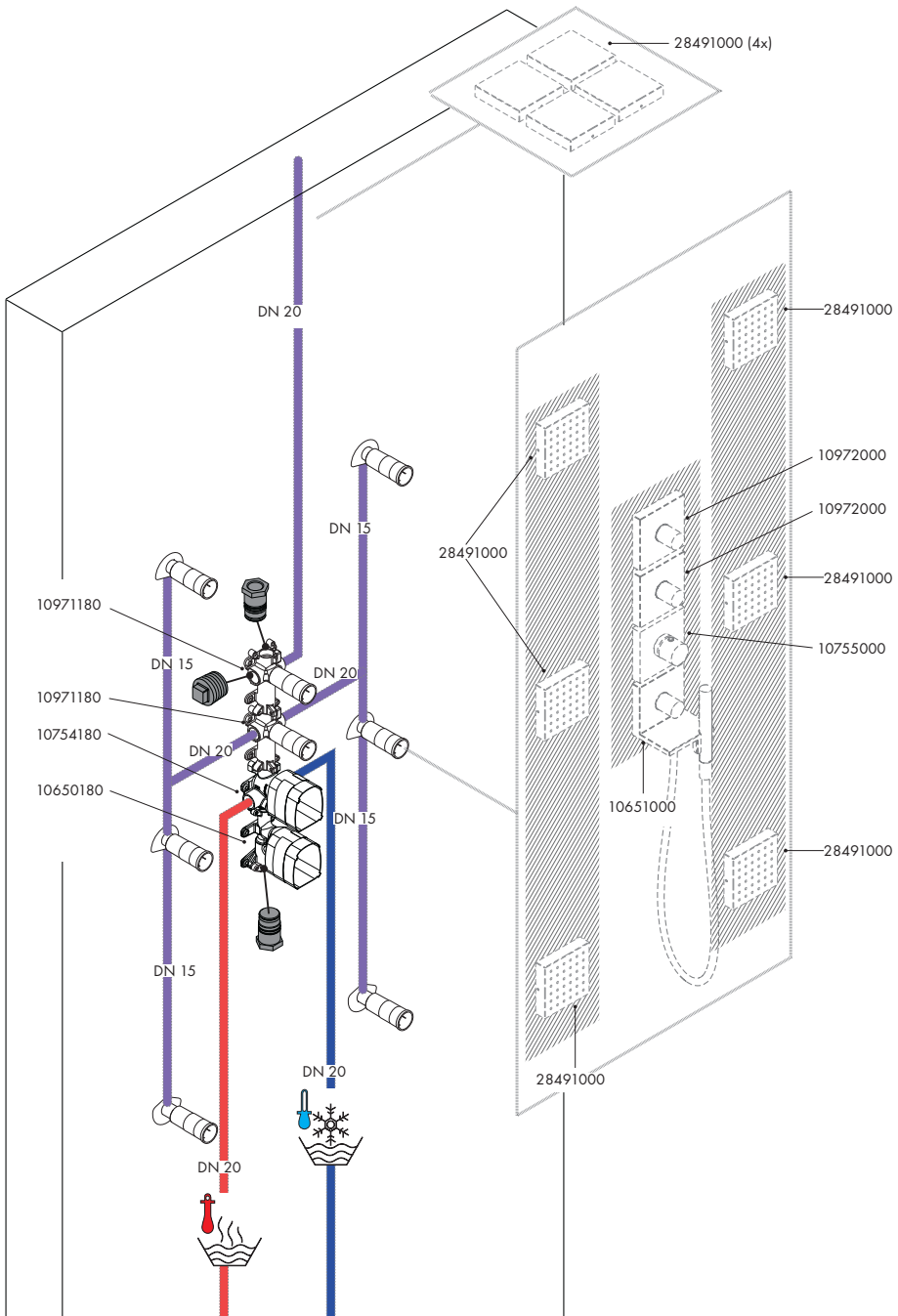

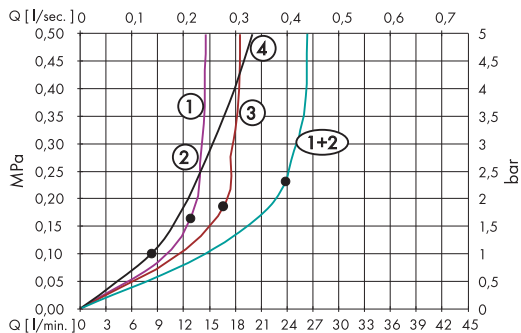

RU Гарантированное функционирование при показателях выше •.

HU A • -ól mőködik az adott funkció.

FI Tämä toiminta on taattu • alkaen.

SV Från • garanteras funktionen.

LT Nuo • funkcionavimas garantuotas

HR Zajamčena funkcija od • navše

TR •'den itibaren fonksiyon garanti edilmiştir.

RO Încercând de la • funcționarea este garantată.

EL Αυτή η λειτουργία διασφαλίζεται από το σημείο κι έπειτα

SL Od • je delovanje zagotovljeno.

DE Ab • ist die Funktion gewährleistet.

FR A partir de • le fonctionnement est garanti.

EN From • the function is guaranteed.

IT Dal • si garantisce la funzionalità.

ES Mínimo • para el correcto funcionamiento.

NL Vanaf • is het functioneren gegarandeerd.

DK Fra • er funktionen anvendelig.

PT • A partir deste ponto inicia-se o funcionamento correcto.

PL Od • możliwe jest funkcjonowanie.

CS „Od • je zaručená funkce„

SK Od • je zaručená funkcia.

ZH 从 • 开始，正常功能得以保证。

ET Alates • on funktsioneerimine garanteeritud

LV No • funkcija nodrošināta

SR Od • je funkcija zagarantovana.

NO F.o.m. • er funksjonen garantert

BG От • функцията е гарантирана.

SQ Nga • është i mundur funksioni.

AR من • ونومضم تفسي طولاً • نم

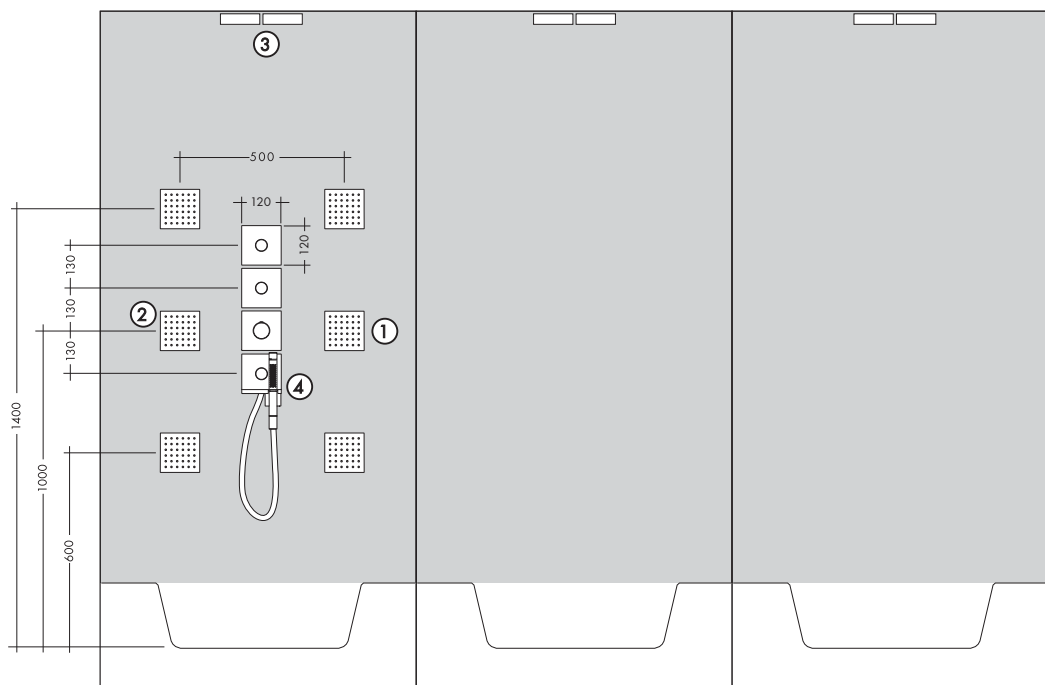

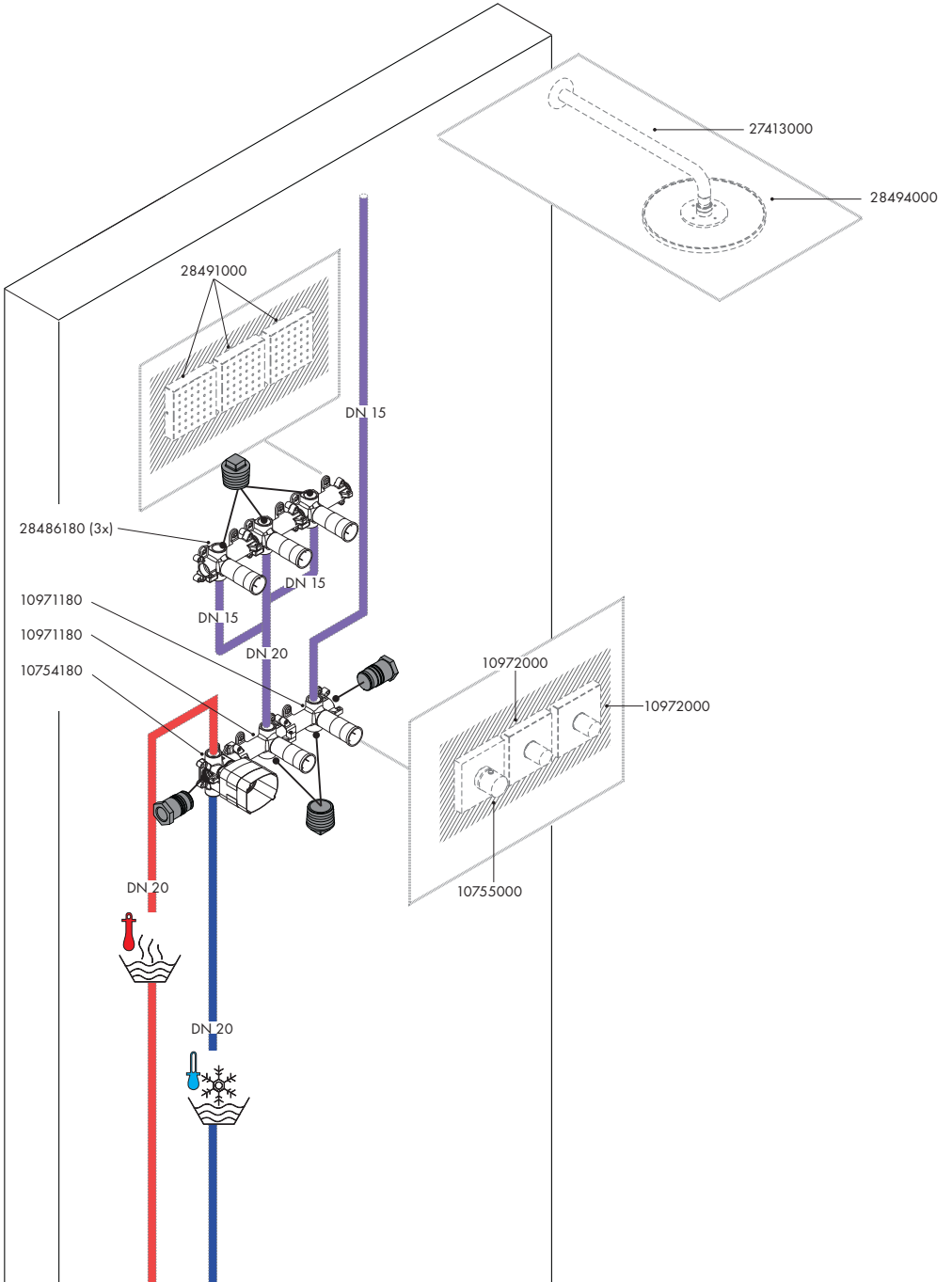

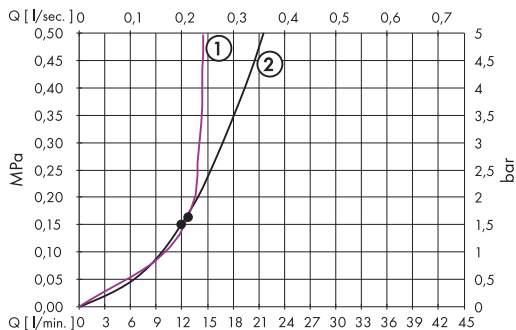

RU Гарантированное функционирование при показателях выше •.

HU A • -ól mőködik az adott funkció.

FI Tämä toiminta on taattu • alkaen.

SV Från • garanteras funktionen.

LT Nuo • funkciovimas garantuotas

HR Zajamčena funkcija od • navise

TR •'den itibaren fonksiyon garanti edilmistir.

RO Încercând de la • funcționarea este garantată.

EL Αυτή η λειτουργία διασφαλίζεται από το σημείο κι έπειτα

SL Od • je delovanje zagotovljeno.

DE Ab • ist die Funktion gewährleistet.

FR A partir de • le fonctionnement est garanti.

EN From • the function is guaranteed.

IT Dal • si garantisce la funzionalità.

ES Mínimo • para el correcto funcionamiento.

NL Vanaf • is het functioneren gegarandeerd.

DK Fra • er funktionen anvendelig.

PT • A partir deste ponto inicia-se o funcionamento correcto.

PL Od • możliwe jest funkcjonowanie.

CS „Od • je zaručená funkce„

SK Od • je zaručená funkcia.

ZH 从 • 开始，正常功能得以保证。

ET Alates • on funktsioneerimine garanteeritud

LV No • funkcija nodrošināta

SR Od • je funkcija zagarantovana.

NO F.o.m. • er funksjonen garantert

BG От • функцията е гарантирана.

SQ Nga • është i mundur funksioni.

AR من • ونومضم تفسي طولاً • نم

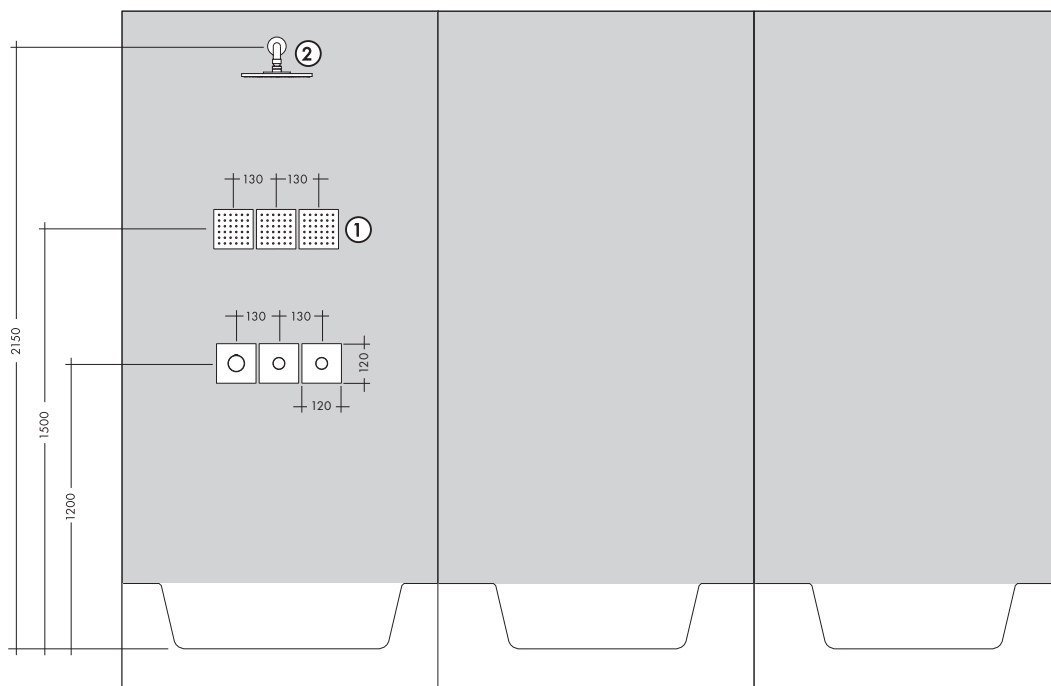

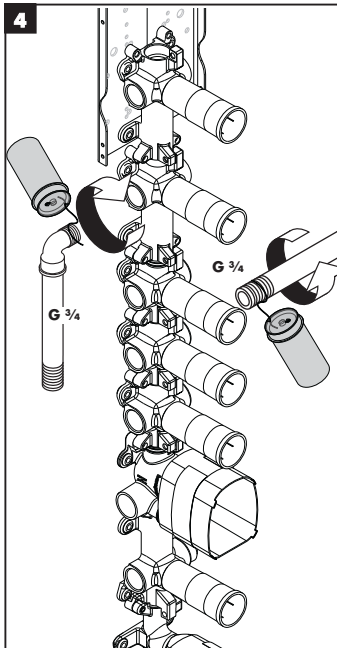
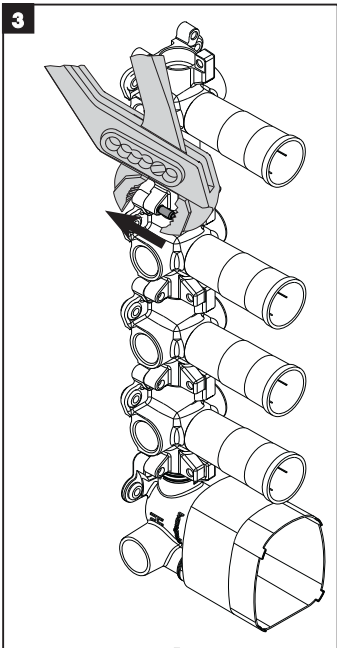
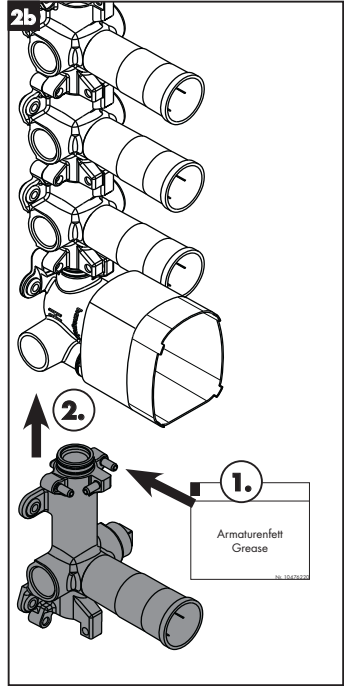
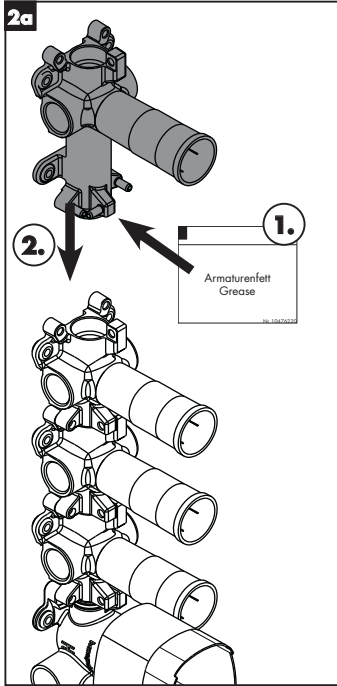
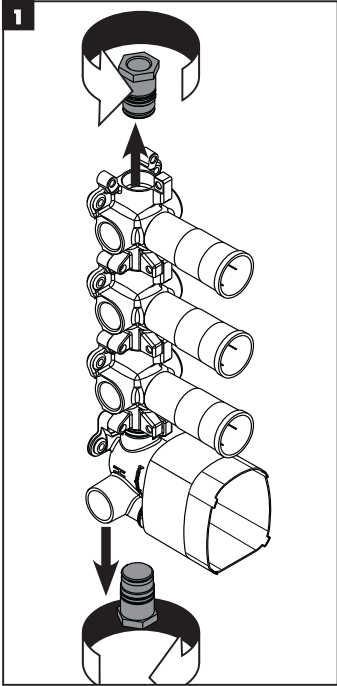

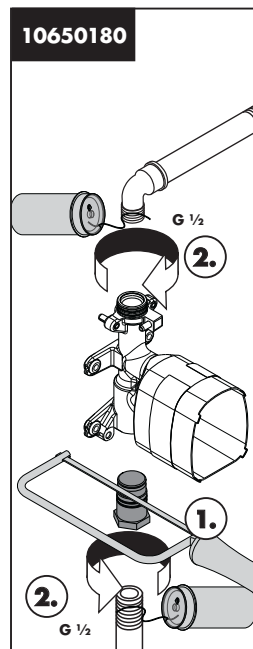
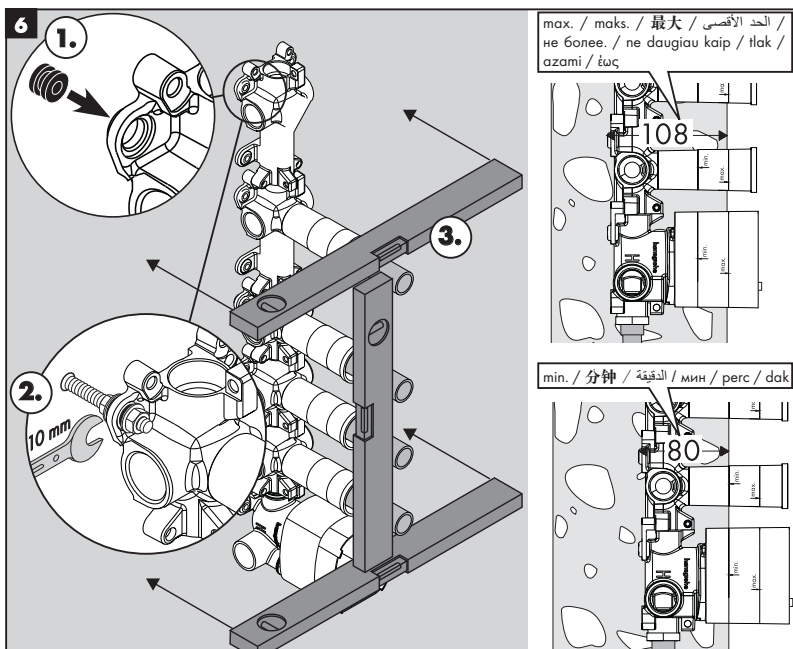
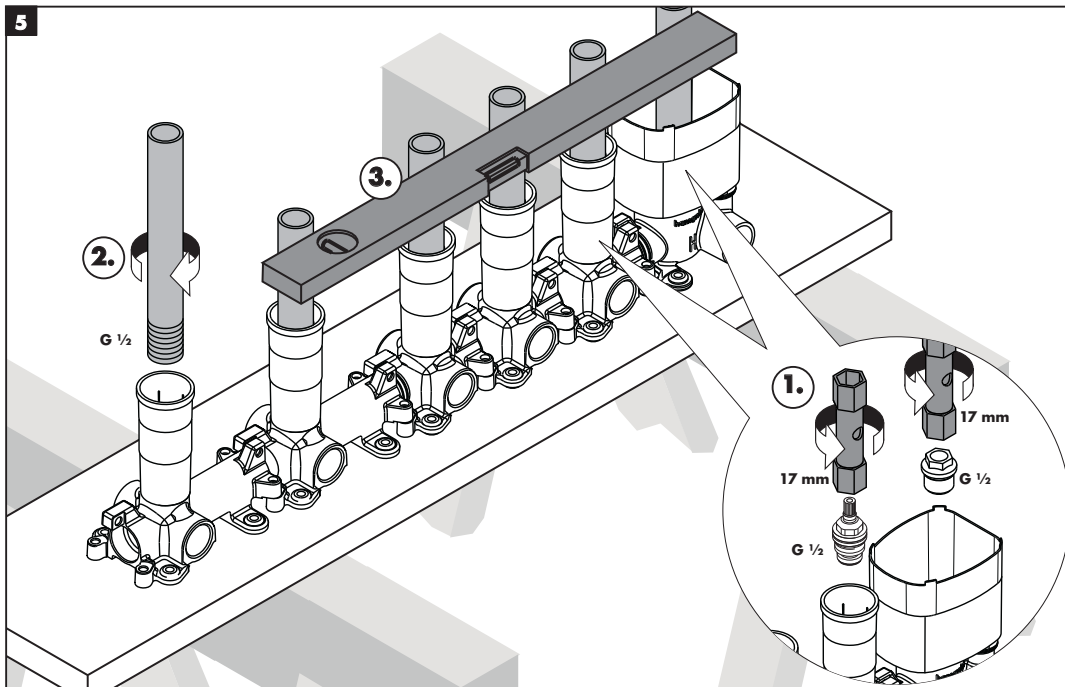

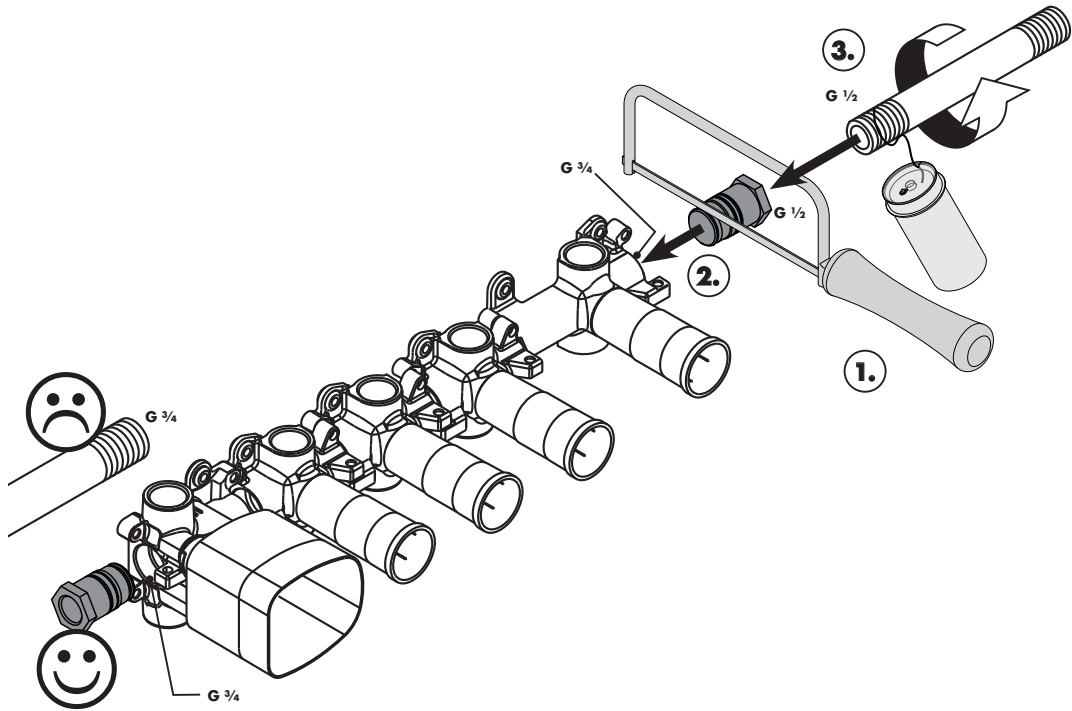

- DE** Wird der beigegefügte Stopfen abgesägt, kann er als Reduziernippel (G 3/4 - G 1/2) verwendet werden (siehe auch Montagebeispiel Seite 32).
- FR** Si le bouchon fourni est scié, il peut être utilisé en tant que réducteur (G 3/4 - G 1/2)
- EN** The enclosed plug can be used as a reducing nipple (G 3/4 - G 1/2) when it is sawn off
- IT** Se il tappo allegato viene segato, lo stesso può essere utilizzato come riduttore (G 3/4 - G 1/2)
- ES** Si se corta el tapón incluido, puede utilizarse como niple reductor (G 3/4 - G 1/2)
- NL** Wanneer de beigevoegde stop wordt afgezaagd kan hij als reduceernippel G 3/4 - G 1/2 worden gebruikt
- DK** Hvis den vedlagte prop savnes, kan der bruges som reduceringsnippel (G 3/4 - G 1/2)
- PT** Se o bujão (incluído no fornecimento) for cortado, é possível utilizá-lo como bocal redutor (G 3/4 - G 1/2)
- PL** Gdy odetnie się dołączoną zatyczkę, wówczas może ona być używana jako złączka redukcyjna (G 3/4 - G 1/2)
- CS** Když se při montáži seřizne přiložená zátká, je možné ji použít jako redukční vsuvku (G 3/4 - G 1/2).
- SK** Ak sa pri montáži oreže priložená zátká, je možné ju použiť ako redukčnú vsuvku (G 3/4 - G 1/2).
- ZH** 断附上的堵头，其可作减速螺纹接套使用 (G 3/4 - G 1/2)
- RU** Если входящую в комплект заглушку требуется обрезать, то она может использоваться как переходник (с G 3/4 на G 1/2)
- HU** Ha a mellékelt dugót elvágja, akkor redukáló csőcsonként (G 3/4 - G 1/2) is használható
- FI** Kun mukana oleva tulppa sahataan irti, sitä voi käyttää sovittimena (G 3/4 - G 1/2)

- SV** Sågar man av den beige färgade proppen kan den användas som reduceringsnippel (G 3/4 - G 1/2).
- LT** Nupjautas kaišis gali būti naudojamas, kaip pereinamasis (G 3/4 - G 1/2) nipelis
- HR** Ako se priloženi čep prereže, može se rabiti kao redukcijska nazuvica (G 3/4 - G 1/2)
- TR** Birlikte verilen tapa kesildiği takdirde, kan er als azaltma nipelini (G 3/4 - G 1/2) olarak kullanılabılır
- RO** Dacă după anexat se taie cu ferăstrăul, acesta poate fi utilizat ca niplu de reducere (G 3/4 - G 1/2)
- EL** Εάν η συνοδευτική τάπα κοπεί με το πριόνι μπορεί να χρησιμοποιηθεί σαν μαστός μικρότερης διατομής (G 3/4 - G 1/2)
- SL** Če priloženemu čepu odžagate vrh, ga lahko uporabite kot reducirino tuljavo (G 3/4 - G 1/2)
- ET** Kui kaasosolev kork maha saagida, saab seda kasutada redutseerimisniplina (G 3/4 - G 1/2)
- LV** Ja pievienotais aizbāznis tiek nozāgēts, to var izmantot kā samazināšanas nipelī (G 3/4 - G 1/2)
- SR** Ako se priloženi čep prereže, može se koristiti kao redukciona nazuvica (G 3/4 - G 1/2)
- NO** Når den medleverte proppen savnes av, kan den brukes som reduksjonsnippel (G 3/4 - G 1/2)
- BG** Ако приложената пробка бъде отрязана, тя може да се използва за прохода нипел (G 3/4 - G 1/2)
- SQ** Nëse tapa e dërguar do të sharrohet, atëherë ajo mund të përdoret si nipel reduktues (G 3/4 - G 1/2)
- AR** يمكن استخدام السدادة المرفقة كنبيب تخفيض (G 3/4 - G 1/2) في حالة قصها

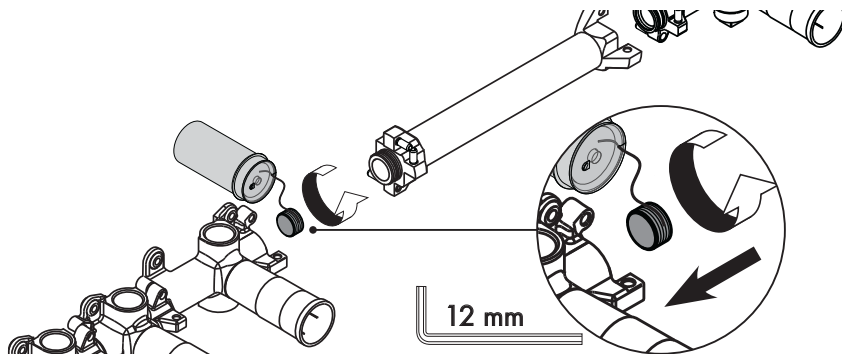

- DE** Stopfen einschrauben
Folgt nach dem Grundkörper 40878/ 40877 kein Absperrventil, dann beigelegten Stopfen eindrehen und einschrauben. So wird stagnierendem Wasser vorgebeugt.
- FR** Visser l'obturateur
Si une vanne d'arrêt ne se trouve pas en aval du corps de base 40878/ 40877, étancher et visser l'obturateur fourni, évitant la stagnation d'eau.
- EN** Screw in the plug
If there is no shutoff valve behind the basic body 40878/ 40877, seal the included plug and screw it in. This will prevent stagnating water.
- IT** Avvitare i tappi
Se dopo il corpo base 40878/ 40877 non segue nessuna valvola d'arresto, allora ermetizzare il tappo e avvitarlo. Con ciò si previene a dell'acqua stagnata.
- ES** Enrosacar tapones
Si después del cuerpo básico 40878/ 40877 no sigue ninguna válvula de cierre, entonces se debe hermetizar y enrosacar los tapones incluidos. De este modo se evita la acumulación de agua.
- NL** Stop erin schroeven.
Indien na het basislichaam 40878/ 40877 geen afsluikklep volgt, moet de bijgevoegde stop afgedicht en ingeschroefd worden. Zo wordt stilstaand water voorkomen.
- DK** Prop skrues i
Er der ikke nogen afspærringsventil efter grundelementet 40878/ 40877, tætnes vedlagte prop ind og skrues i. Således forebygges stagnerende vand.
- PT** Enrosacar o bujão
Se depois do corpo base 40878/ 40877 não se seguir nenhuma válvula de vedação, não se deve enrosacar nem vedar o bujão fornecido. Desta forma previne a formação de água estagnada
- PL** Wkręcanie korka
Jeżeli za korpusem 40878/ 40877 nie ma żadnego zaworu odcinającego, wówczas należy uszczelnić i wkręcić dołączony korek. W ten sposób zapobiega się gromadzeniu wody.
- CS** Našroubování uzávěru
Jestliže za základním tělesem 40878/40877 nenásleduje uzavírací ventil, potom utěsněte a našroubojte přiložený uzávěrý. Předějde se tím stagnující vodě.
- SK** Nasrúkovanie uzáverov
Ak za základným telesom 40878/40877 nie je uzatvárací ventil, potom utesnite a nasrúkovajte priložený uzáverý. Predídete sa tým stagnujúcej vode.
- ZH** 拧固堵头
基体 40878/ 40877 之后无截止阀，因此用堵头进行密封并用螺钉拧固，以防止停滞。
- RU** Ввинтите заглушки
Если за основной частью 40878/ 40877 нет запорного клапана, тогда загерметизируйте и ввинтите приложенные заглушки. Таким образом, удастся предотвратить застывание воды.
- HU** Dugó becsavarása
Ha a 40878/40877 készüléktest után nincs zárószelep, akkor a mellékelt dugót kell behelyezni és becsavarni. Így meg lehet előzni a víz pangását.
- FI** Tulpat ruuvataan kiinni
Jos perusosan 40878/ 40877 jälkeän ei tule sulkuventtiiliä, mukana olevat tulpat tiivistetään ja ruuvataan kiinni. Näin estetään veden kerääntyminen.

- SV** Skruva i propp
Om det inte finns en spärrventil efter basenheten 40878/ 40877 ska den medföljande proppen sätts in och skrivas fast. Detta förebygger vattenstagnation.
- LT** Kamščio užsikimas
Jeigu už pagardinės dalies 40878/40877 nėra skiriamoji vožtuvo, užsandarinkite ir užsikite pridedamus kamščius. Taip išvengiama vandens užsistovėjimo.
- HR** Zavrtanje čepa
Ako iza tijela 40878/40877 ne slijedi zaporni ventil, onda priloženi čep treba zabrtviti i zavrtnuti. Na taj se način izbjegava stagniranje vode.
- TR** Tapayı takın
Temel gövde 40878/ 40877 den sonra kapatma vanası yoksa, birlikte verilen tapayı izale edin ve vidalayın. Böylece suyun durgunlaşması önlenir.
- RO** Înşurubarea dopului
În cazul în care după corpul de bază 40878/ 40877 nu este montată o supapă de închidere, etanşaţi dopul anexat şi înşurubaţi-l. În acest fel veţi evita formarea apei stagnante.
- EL** Βιδώστε το βύσμα
Εφόσον δεν εγκατασταθεί μετά το βασικό στοιχείο 40878/ 40877 μία βαλβίδα διακοπής, θα πρέπει το βύσμα να βιδωθεί και να στεγανοποιηθεί ώστε να μην συγκεντρώνεται νερό.
- SL** Uvijte zamašek
Če za osnovnim elementom 40878/ 40877 ni nameščena zaporna ventila, zatesnite in uvijte priložen zamašek. Tako preprečite nabiranje stagnirajoče vode.
- ET** Keerake kork sisse.
Kui pühikerele 40878/ 40877 ei järgne sulgurventiili, siis tihendage kork ja keerake sisse. Sellega väldite seisvat vett.
- LV** Aizbāžņu ieskrūvēšana
Ja pēc pamatnes 40878/ 40877 neseko slēgvārstis, noblīvējiet un ieskrūvējiet pievienotos aizbāžņus. Tādējādi tiek novērsta ūdens sastāšanās.
- SR** Skru inn plugg
Hvis ikke det følger en sperreventil etter basiskabinettet 40878/40877 skal man skru inn og tette med medlevert plugg. Slik forebygges stagnerende vann.
- NO** Skru inn plugg
Hvis ikke det følger en sperreventil etter basiskabinettet 40878/40877 skal man skru inn og tette med medlevert plugg. Slik forebygges stagnerende vann.
- BG** Завинтите пробката
Ако след основното тяло 40878/ 40877 няма спирален клапан, тогава уплътнете и завинтите приложената пробка. Така се предотвратява застоя на вода.
- SQ** Vidhosni tapër
Nëse pas njësisë kryesore 40878/ 40877 nuk vjen asnjë valvul bllokuese, atëherë izoloni dhe vidhosni tapat e dërguara. Në këtë mënyrë do të parandalohet uji i ndenjtur.

تركيب السدادات

إذا لم يتبع الجسم الرئيسي / صمام مائع للتدفق، قم بتركيب السدادات المرصقة وثبتها بلحكام، مما سيمنع تكون أي مياه راكدة.



- DE** Spülen der Leitungen
FR Rincer les conduites
EN Flushing of the pipes.
IT Far scorrere l'acqua nel tubo
ES Limpiar lavando los conductos
NL Doorspoelen van de leidingen
DK Skylling af ledninger
PT Lavagem das tubagens
PL Płukanie przewodów
RU Промывка трубопроводов
CS vypláchnout vedení
SK Vypláchnutie vedení.
ZH 冲洗管道。
HU A vezetékek öblítése
FI Johdotusten huuhtelu
SV Spola ledningarna
LT Išplauti vamzdžius
HR Ispiranje slavina
TR Hatların yıkanması
RO Spălarea conductelor
EL Καθαρισμός των αγωγών
SL Izpiranje cevi
ET Torude loputamine
LV Ūdens vada skalošana
SR Ispiranje cevi
NO Spyling av ledninger
BG Промиване на тръбопроводите
SQ Shpëlarja e lidhjeve
AR غسيل المواسير

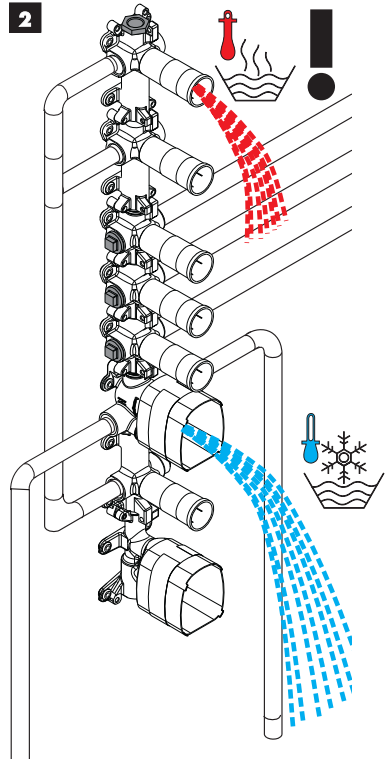
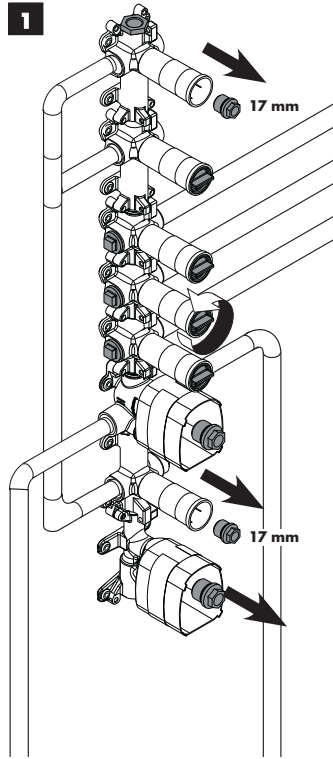

**DE****FR****EN****IT**

Eingebaute und geprüfte Grundkörper einputzen, bzw. bei Vorwandinstallation mit Wandverkleidungssystem beplanen.

Nach Austrocknen der verputzten Wandoberfläche, die Nahtstelle zwischen Wand und Kunststoffgehäuse mit Silikon (essigsäurefrei!) ausspritzen.

Crépir le corps de base monté et contrôlé ou - dans le cas d'une installation sur mur, le recouvrir à l'aide du système d'habillage de mur. Une fois le crépi sec à la surface des murs, injecter une couche de silicose (exempte d'acide acétique) au niveau du cordon de raccord plastique.

Plaster the installed and tested basic components, or cover with panelling if installed on the exterior of the wall. After the plastered wall surface has dried, fill the seam between the wall and the plastic housing with silicone (free of acetic acid).

Incassare sotto intonaco i corpi base montati e controllati, risp. con installazione a parete con sistema di rivestimento parete sotto pannelli. Dopo l'asciugamento della superficie parete intonacata, riempire le cuciture tra parete e scatola di plastica con silicose (esente di acido acetico!).

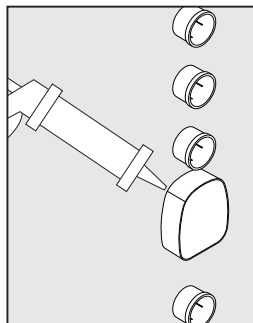

PCI-Lastogum oder einen vergleichbaren Dichtstoff nach Herstellerangaben auf die Wand auftragen.

Recouvrir le mur avec du PCI-Lastogum ou un matériel d'étanchéité comparable.

Apply PCI-Lastogum or similar sealing compound on the wall in accordance with manufacturers indications.

Applicare sulla parete PCI-Lastogum o un materiale a tenuta ermetica simile in base alle indicazioni fornite dal produttore.

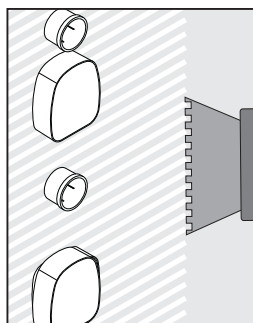

Dichtmanschette zuschneiden. Hinweis! Dichtmanschetten dürfen nicht überlappen.

Couper la lamelle à la taille voulue. Les lamelles ne doivent pas se chevaucher.

Cut sealing collar to size. Sealing collars must not overlap.

Ritagliare il manicotto di guarnizione. I manicotti di guarnizione non devono sovrapporsi.

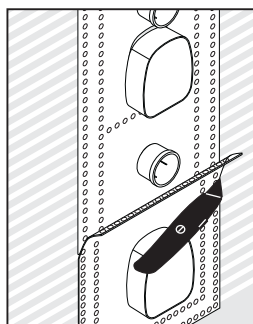

Dichtmanschette über das Kunststoffgehäuse stülpen, fest in den Kleber und Silikon drücken.

Retourner la manchette étanche sur le boîtier en plastique et l'enfoncer dans la colle et la silicose.

Place a sealing collar over the plastic housing and press it into the glue and the silicone.

Rimboccare il manicotto di guarnizione sopra la scatola di plastica e premerlo nella colla e nel silicose.

Achtung! Die Dichtmanschette nicht heißverkleben.

Attention! La manchette étanche ne doit pas être collée à chaud.

Important! The gasket is not suitable for hot glue.

Attenzione!!! manicotto di tenuta non deve essere incollato a caldo.

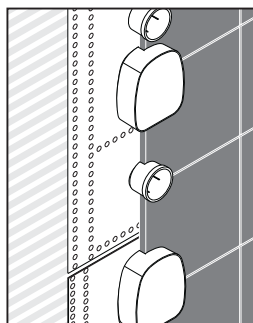

**ES****NL****DK****PT****PL**

Cubrir con yeso los cuerpos montados y comprobados o cubrir con el sistema de revestimiento mural en caso de instalación de pared falsa. Una vez que la superficie mural ya esté seca, inyectar silicona (sin ácido acético) en la costura entre el muro y la carcasa de plástico.

Ingebouwde en gecontroleerde basislichaam inwerken resp. bij voorzetwanden van wandbekleding voorzien. Nadat het bepleisterde muuroppervlak opgedroogd is, de naad tussen de wand en de kunstof behuizing met silicone (zonder azijnzuur!) dichtspuiten.

Monterede og afprøvede grundelementer pudses, hhv. ved installationer på forvægge forsynes de med planker (indfatning) Efter pudsen på vægoverfladen er tør, skal samlingen mellem væg og kunststofkassen sprøjtes med silikone (fri for eddikesyrel).

Encastrar corpos base montados e verificados ou colocar sistema de revestimento de parede, no caso de instalação de parede falsa. Após secagem da superfície da parede areada, deve-se encher a junta entre a parede e a caixa de plástico com silicone (sem ácido acético!).

Zabudowane oraz sprawdzone korpusy zatynkować, względnie w przypadku instalacji w okładzinach ściennych przykryć okładziną ścienną. Po wyschnięciu zatynkowanej powierzchni ściany miejsce styku ściany z obudową z tworzywa sztucznego pokryć silikonem (niezawierającym kwasu octowego).

Aplicar en la pared una cola estanqueizadora según las indicaciones del fabricante.

PCI Lastogum of een vergelijkbaar afdichtingsmateriaal (zie voorschriften fabrikant) op de wand aanbrengen.

Påfør væggen vådrumsmembran eller en lignende klæbemasse.

Aplicar PCI-Lastogum ou um composto vedante similar na parede de acordo com as indicações do fabricante.

Wyrównać powierzchnię ściany specjalnym środkiem wyrównująco-uszczelniającym.

Cortar manguito de estanqueidad. No deben sobreponerse los manguitos de estanqueidad.

Afdichtring op maat snijden Afdichtringen mogen niet overlappen

Klippe tætningsmanchetten Tætningsmanchetter må ikke overlappe.

Cortar a manga de vedação no tamanho correcto. As mangas de vedação não se podem sobrepor.

Przyciąć manszetę uszczelniającą. Manszety uszczelniające nie mogą się nakładać.

Dar vuelta al manguito obturador sobre la carcasa de plástico e insuflar pegamento y silicona.

Afdichtmanchet over de kunststof behuizing trekken en in de lijm en silicone duwen.

Tætningsmanchetten smøges over kunststofkassen og trykkes ind i limen og silikonen.

Montar a manga de vedação sobre a caixa de plástico e pressionar contra a cola e o silicone.

Pierścień samouszczelniający nałożyć na obudowę z tworzywa sztucznego i wcisnąć w klej i silikon.

¡Atención!El manguito de estanqueidad no debe pegarse en caliente.

Attentie!De dichtmanchet mag niet warm omwikkeld worden.

Advarsel!Der må ikke bruges smeltelim til tætningsmanchetten.

Atenção!A junta de vedação não pode ser colada a quente.

Uwaga!Nie można przyklejać na gorąco mankietu uszczelniającego.



Zabudovanou a zkontrolovanou kostru zakryjte omítkou, příp. jí při instalaci před zeď zakryjte systémem na obkládání zdí. Po zaschnutí omítky vyplňte spáry mezi stěnou a plastovým krytem silikonem (bez kyseliny octové!)

Zakryte zabudovanú a skontrolovanú kostru omietkou, príp. ju pri inštalácii pred stenu pokryte systémom na obloženie stien. Po zaschnutí omietky vystriekajte silikónom (bez kyseliny octovej!) štrbiny medzi stenou a plastovým krytom.

将已经安装并经过检验的基体抹灰，或者在安装前壁时用壁覆面系统将其包覆。已抹灰的壁表面干燥后，使用硅胶（不含醋酸）对壁与塑料外壳之间的接缝点进行喷塑。

Встроенные и проверенные основные части заштукатурить либо при монтаже на стене облицовочной системы. После высыхания поверхности стены, заполнить шов между стеной и пластмассовым комплексом силиконом (не содержащим уксусной кислоты).

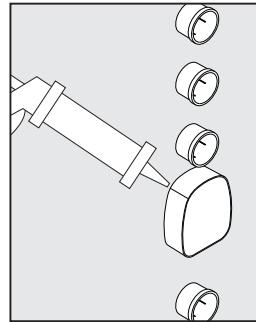

Na stěnu nanést PCI-Lastogum nebo nějakou srovnatelnou těsnicí hmotu podle pokynů výrobce.

Na stenu naniesť PCI-Lastogum, alebo porovnateľný tesniaci materiál podľa pokynov výrobcu.

遵照制造商的说明，在边壁上使用PCI胶黏层或类似的密封材料。

Нанесите на стену PCI-Lastogum или подобный герметик, указанный изготовителем.

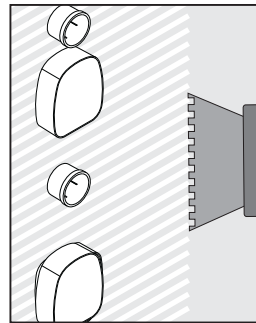

Ořízněte těsnící manžety. Těsnící manžety se nesmí překrývat.

Orežte tesniace manžety. Tesniace manžety sa nesmú prekryvať.

锯开密封涨圈。密封涨圈不可重叠。

Разрезать уплотнительную манжету. Запрещается соединять уплотнительные манжеты внахлестку.

Plastový kryt překryjte těsnící manžetou a vtačte ji do lepidla a silikonu.

Príkryte tesniacou manžetou plastový kryt a zatlačte ju do lepidla a silikónu.

将密封圈套到塑料外壳上并压到胶水和硅胶中。

Уплотнительную манжету надеть на пластмассовый корпус и закрепить при помощи клея и силикона.

Pozor! Těsnící manžeta nesmí být slepená za horka.

Pozor! Tesniaca manžeta nesmie byť lepená za horúca.

注意！不能热粘贴密封涂层。

ВНИМАНИЕ! Уплотнительную манжету не разрешается приклеивать горячим способом.

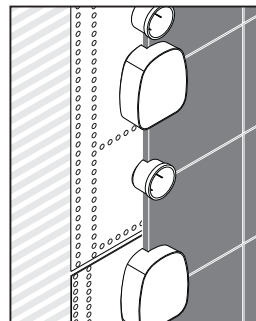
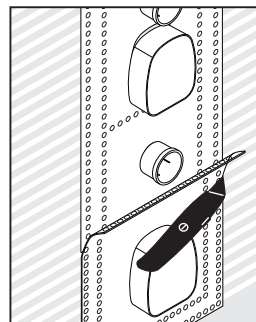

**HU****FI****SV****LT****HR**

A beépített és ellenőrzött alaptestet bevakolni, ill. előfal felszerelés esetén a falburkolat rendszerrel beborítani. A bevakolt falfelület kiszáradása után, a fal és a műanyag burkolat közötti hézagot szilikonnal (ecetsav mentes!) kifújni.

Sisäänrakennetut ja tarkistetut perusosat rapataan tai peitetään seinäsennuksessa seinäverhouksella. Rapatun seinäpinnan kuivumisen jälkeen sauma seinä ja muovikotelon välissä täytetään silikonilla (ilman etikkahappoa).

Finputsa inbyggda och testade basenheter eller sätt på panel vid utvändigt vägginstallation. När den putsade väggytan har torkat tätas skarven mellan väggen och plastkåpan med silikon (utan ättiksyra).

Išvalykite sumontuotą ir patikrintą pagrindinę dalį, įrengdami priekinę sieną, apkalkite ją lentelėmis. Kai išvalyti sienų paviršiai išdžiūs, plyšius tarp sienų ir plastikinio korpuso užpildykite silikonu (be acto rūgšties!).

Ugrađena i provjerena tijela ožbukajte, tj. kod predizdrih instalacija obložite sustavom za oblaganje zidova. Nakon sušenja ožbukanoj zida poprskajte spoj između zida i plastičnog kućišta silikonom (koji ne sadrži octenu kiselinu).

Hardjuk fel a falra a PCI-Lastogum-ot vagy a hasonló szigetelőanyagot a gyártó előírásainak megfelelően.

Levitä seinään PCI-Lastogum:ia tai vastaavaa tiivistäinettä valmistajan ohjeiden mukaisesti.

Lägg på PCI-Lastogum, eller ett jämförbart tätningsmaterial, på väggen enligt tillverkarens anvisningar.

Vadovaudamiesi gamintojo nurodymais, užtepkite ant sienos PCI Lastogum ar panašią sandarinamąją priemonę.

Nanesite na zid PCI-Lastogum ili neki slični brtvneni materijal sukladno navodima proizvođača.

A tömitőkarmantyút megfelelő nagyságra vágni. A tömitőkarmantyúknak nem szabad egymást fedni.

Leikataan sopiva tiivistysmansetti. Tiivistysmansetteja ei saa limittää.

Skär till tätningsmanschett. Tätningsmanschetter får inte överlappa.

Pritaikykite sandarinimo manžetą. Sandarinimo manžetų kraštai neturi persidengti

Izrežite manžetu za brtvljenje. Manžete za brtvljenje se ne smiju preklapati.

A tömitő mandzsettát a műanyag burkolatra húzni és a ragasztóba, valamint a szilikonba benyomni.

Tiivistysrengas vedetään muovikotelon päälle ja työnnettään liimaan ja silikoniiin.

Trä en tätningsmanschett över plastkåpan och tryck in den i limmet och silikonet.

Ant plastikinio korpuso uždekite sandarinimo movą ir įspauskite į kljusį ir silikoną.

Prevcite brtvnu manžetu preko plastičnog kućišta pa ju utisnite u ljeplivo i silikon.

Figyelem!A szigetelő gumigyűrűt nem szabad forróra felragasztani.

Huomio!Tiivistekaulusta ei saa kuumaliimata.

OBS!Tätningsmanschetten får inte varmlimmas.

Dėmesio!Sandariklio nekljuokite karštuojai būdu.

Pažnjal!Manžetu za brtvljenje ne smijete lijepiti vrućim ljeplivom.

TR**RO****EL****SL**

Montađı yapılan ve kontrol edilen temel gövdeyi sıvaya yerleřtirin ya da ön duvar tesisatında duvar kaplama sistemiyle kaplayın.

Duvar yüzeyinin sıvası kuruduktan sonra duvar ile plastik gövde arasına silikon (asit asetsiksiz!) püskürtün.

Tencuiți corpurile de bază incorporate și testate, respectiv în cazul instalării unui perete acoperitor înveliți cu profile de acoperire.

După uscarea suprafeței de perete tencuit, umpleți spațiul dintre perete și carcasa de plastic cu silicon (fără conținut de acid acetic!).

Σοβατιστε μετά τον έλεγχο τα κουτιά που εγκαταστήσατε ή επενδύσατε τα με γυψοσανίδες σε περίπτωση επίτοιχης εγκατάστασης.

Όταν στεγνώσει η σοβαντισμένη επιφάνεια του τοίχου γεμίστε τον αρμό μεταξύ τοίχου και πλαστικού περιβλήματος κουτιού με σιλικόνη ανθεκτική σε όξινα καθαριστικά.

Vgrajene in preizkušene osnovne elemente prekritje z ometom oz. Pri instalaciji na steno s sistemom stenskih oblog.

Po osušitvi ometene površine stene s silikonom zapolnite slična mesta med steno in ohišjem iz umetne mase (brez očetne kisline!).

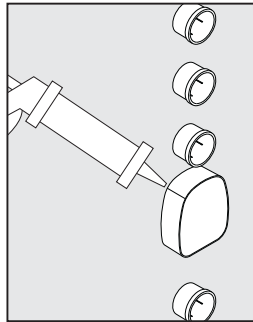

PCI-Lastogum ya da üretici bilgilerine göre benzer bir izolasyon maddesini duvara uygulayın.

Se aplică pe perete PCI-Lastogum sau un alt material de etanșare, în conformitate cu indicațiile fabricantului.

Κάνετε χρήση PCI-Lastogum ή κάποιου άλλου αντίστοιχου στεγανοποιητικού υλικού για τον τοίχο σύμφωνα με τις οδηγίες του κατασκευαστή.

Na steno po navodilih proizvajalca nanosite PCI-Lastogum ali primerljivo tesnilno maso.

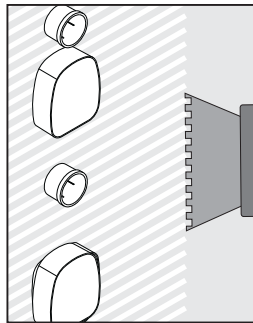

Sızdırmazlık manşetini kesme. Sızdırmazlık manşetleri üst üste binmemelidir.

Tăiați mașeta de etanșare. Manșetele de etanșare nu trebuie să se suprapună.

Κόψτε το κολάρο στεγανοποίησης. Τα κολάρια στεγανοποίησης δεν πρέπει να αλληλοεπικαλύπτονται.

Prirézite tesnilno manšeto. Tesnilne manšete se ne smejo prekriivati.

Conta manşetini plastik gövdenin üzerine geçirin ve yapıştırıcı ile silikonu içine bastırın.

Aplicaiți mașeta de etanșare pe carcasa de plastic și arăsați-o în lipici și silicon.

Τοποθετήστε το στεγανοποιητικό κορδόνι πάνω από το πλαστικό περίβλημα και πιέστε το στην κόλλα και τη σιλικόνη.

Na ohišje iz umetne mase nataknite tesnilno manšeto in vtisnite v lepilo in silikon.

Önemli!Körük sıcak tutkallanmamalıdır.

Atenție!Manșeta de etanșare nu trebuie lipită la cald.

Προσοχή!Η περιμετρική στεγανοποίηση δεν πρέπει να κολληθεί εν θερμώ

Pozor!Tesnilna manšeta se ne sme zlepitii z vročim lepilom.

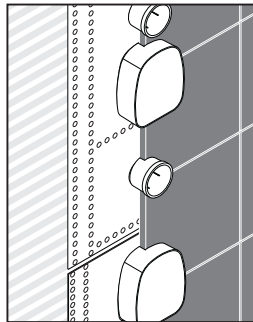
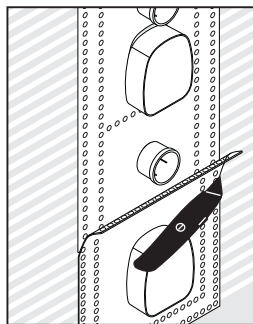

**ET****LV****SR****NO****BG**

Katke sisseehitatud ja kontrollitud korpus krohviga või seinapealse paigalduse korral seinakattega.

Pärast krohvitud seinapinna kuivamist laske sein ja plastkopruse vahelisse ühenduskohta (äädikhappevaba) silikooni.

Iebūvētas un pārbaudītas nesējkonstrukcijas pārklājiet ar apmetumu vai, instalējot priekšējā sienā, - ar sienas pārklāšanas sistēmu.

Pēc apmetās sienas virsmas nožūšanas aizpildiet šuvi starp sienu un plastmasas korpusu ar silikonu (bez etiķskābes!).

Ugrađena i ispitana tela izmalterišite, tj. kod predzidnih instalacija obložite sistemom za oblaganje zidova.

Nakon sušenja omalterisnog zida potrebno je da se spoj između zida i plastičnog kućišta poprška silikonom (koji ne sadrži sirćetnu kiselinu).

Innebygd og kontrollert basiskabinett presses inn, hhv. ved installasjon foran en vegg monteres veggpanel.

Når murpussen har tørket, skal sprekken mellom veggen og plastkabinettet tettes med silikon (eddiksyrefri).

Нанесете мазилка върху монтираното и проверено основно тяло, респ. го облицовайте със система за облицоване на стената при монтаж пред стената.

След изсъхване на мазилката на повърхността на стената, мястото на свързване между стената и пластмасовия корпус да се напърска със силикон (без оцетна киселина!).

Kandke seinale PCI-Lastogum'i või mõnda võrdväärset tihendusainet vastavalt tootja andmetele.

Aizbilstoši ražotāja norādījumiem uzklājiet uz sienas PCI-Lastogum vai līdzīgu hermētīki.

Nanesite na zid PCI-Lastogum ili neki slični zaptivni materijal u skladu sa navodima proizvođača.

PCI-Lastogum eller en lignende tetningmasse påføres veggen iht. produsentforskrifter.

Na stenata da se nanese PCI-Lastogum ili upltnjvaoc materijal, podoben na nego po dannu na proizvođitelja.

Löigake tihendusmansett sobivaks.

Tihendusmansetid ei tohi katuda.

Piegrieziet manšetblīvi.

Manšetblīves nedrīkst pārklāties.

Izrežite zaptivnu manžetnu.

Zaptivne manžetne ne smeju da se preklapaju.

Klippe til tetningsmansjett.

Tetningsmansjetter skal ikke overlappes.

Отрежете уплътнителния маншет според размерите.

Уплътнителните маншети не бива да се припокриват.

Pange tihendusmansett plastkorpusele ning suruge liimi ja silikooni sisse.

Manšeti uzmauciet uz plastmasas korpusa un iespiediet limē un silikonā.

Prevucite zaptivnu manžetnu preko plastičnog kućišta i utisnite u lepak i silikon.

Tetningsmansjetten trekkes over plastkabinettet og trykkes inn i limet og silikonen.

Уплътнителният маншет да се нахлузи на пластмасовия корпус и да се залепи със силикон като се притисне.

Tähelepanu!Tihendusmuhi ei tohi kuumliimida.

Uzmanību!Blīvēšanas manšeti nedrīkst salīmēt ar karstu limi.

Pažnja!Zaptivna manžetna ne sme da se lepi vrućim lepkom.

Obs!Tetningsmansjett må aldri limes varm.

Внимание!Уплътнителният маншет не трябва да се лепи по топъл начин.



Pafinoni skeletin kryesor të integruar dhe të provuar ose mbulojeni atë me sisteme të veshjes së murit gjatë instalimit të murit të përparmë. Pas tharjes së sipërfaqes së pastruar të murit, lyeni me silikon (pa acid acetik!) vendin e bashkimit midis murit dhe kutisë plastike.

يجب إدخال الأجزاء المركبة داخلياً والمختبرة في الملاط، وكذلك في حالة التركيب على الحائط يجب التغطية بأنظمة التغطية الحائطية. بعد جفاف أسطح الحوائط يجب ملأ المكان بين الحائط والتركيبية البلاستيكية بمادة السليكون (خال من الخل الحامضي).

Lyeni murin me PCI-Lagostum ose me ndonjë lëndë të ngjashme izoluese.

قم بوضع مادة PCI- Lagostum أو أي مركب مانع للتسرب على الجدار وفقاً لتعليمات الشركة المنتجة.

Pritni guarnicionin izolues. Guarnicionet izoluese nuk duhen përthyer.

قص الجلبة. ملحوظة! ممنوع تراص الجلب فوق بعضها البعض.

Vendoseni guarnicionin izolues mbi kutinë plastike dhe ngjisheni te ngjithësja dhe silikonin.

يجب تغطية التركيبية البلاستيكية بسدادة واضغط المادة اللاصقة والسليكون للداخل

Kujdes! Mansheta izoluese nuk duhet ngjitur me ngjithës të nxehtë.

تنبيه! لا يسمح بلصق الكم المانع للتسرب على الساخن.

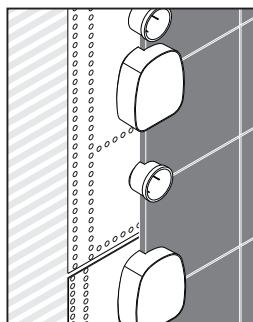
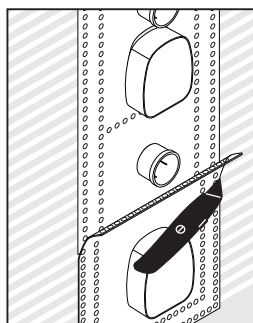
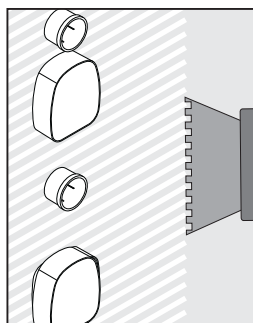
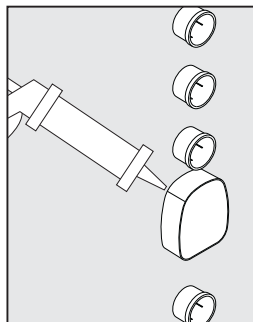

10754180

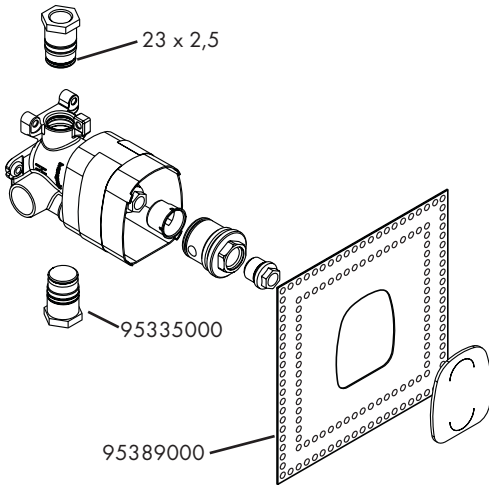

hansgrohe