

Montageanleitung

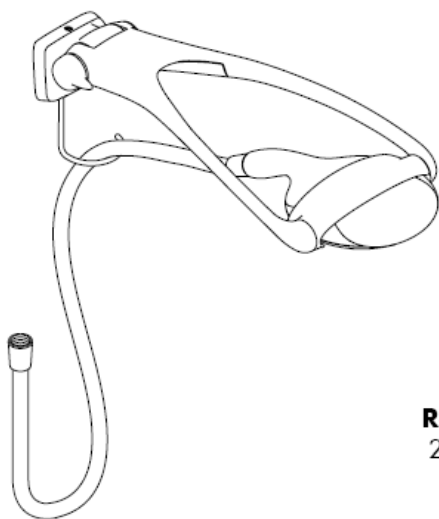

Raindance
28105000

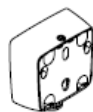

Raindance
28108000

Raindance Allrounder Set
28100000 / 28110000

hangrohe

Raindance Allrounder Set

28100000 / 28110000

Classification acoustique et débit 28110000: ACS

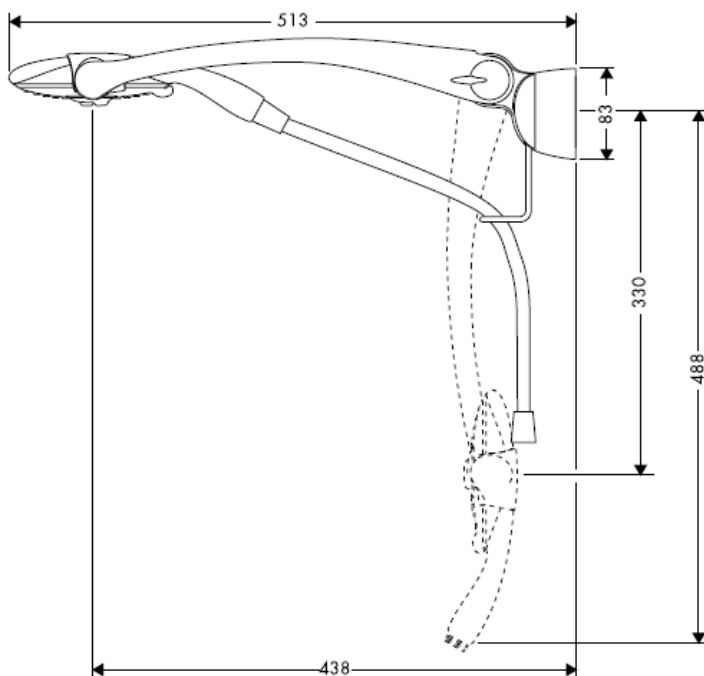

Raindance Eckmontage Set

28105000



Raindance UP-Adapter für Schlauchanschluß

28108000



Raindance Allrounder Set

28100000 / 28110000

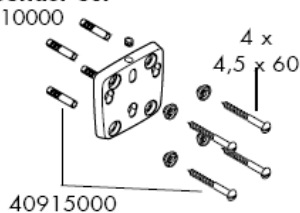

98562000

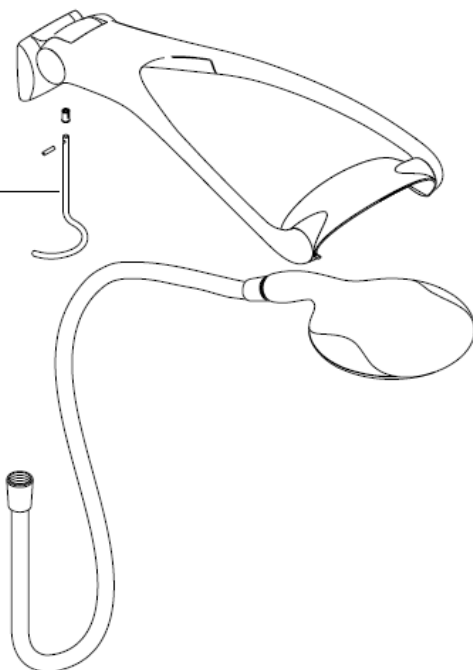

Raindance Eckmontage Set

28105000

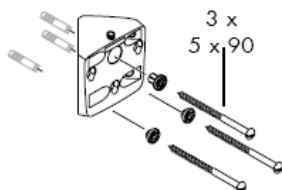

Raindance UP-Adapter für Schlauchanschluss

28108000

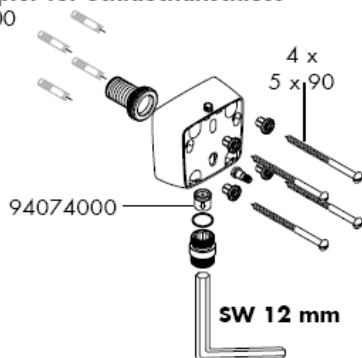

Montage

Der beige packte Filtereinsatz (A) muss eingebaut werden, um den Normdurchfluss der Handbrause zu gewährleisten und um Schmutzeinspülungen aus dem Leitungsnetz zu vermeiden. Wird ein größerer Wasserdurchfluss gewünscht, muss anstelle des Filtereinsatzes (A) die Siebdichtung (B) eingesetzt werden.

Schmutzeinspülungen können die Funktion beeinträchtigen und/oder zu Beschädigungen an Funktionsteilen der Handbrause führen, für hieraus ergebende Schäden haftet Hansgrohe nicht.

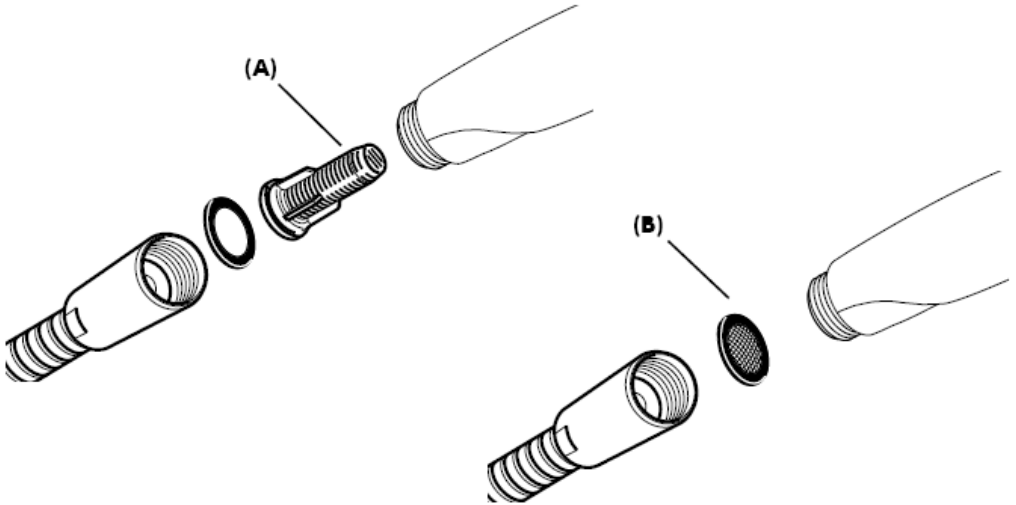

Mit Filtereinsatz (A)

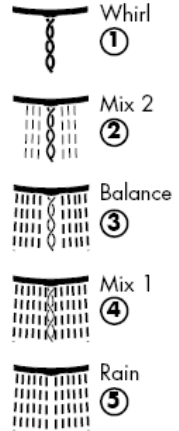
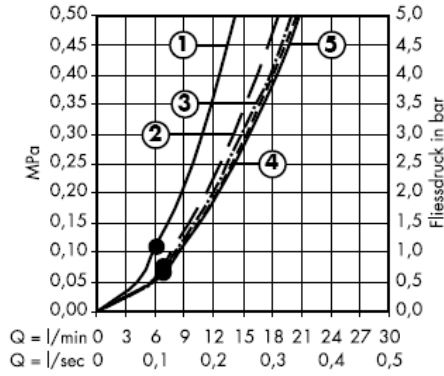

Mit Siebdichtung (B)

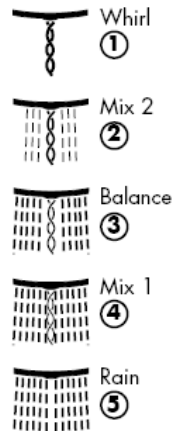
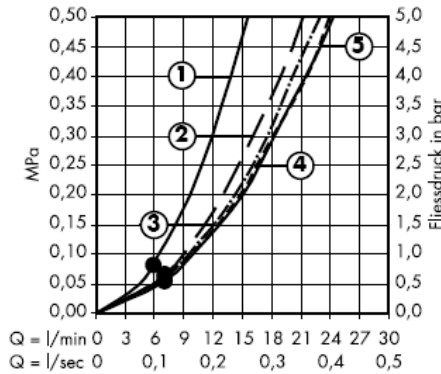

Ab • ist die Funktion gewährleistet.

Mit Filtereinsatz (A)

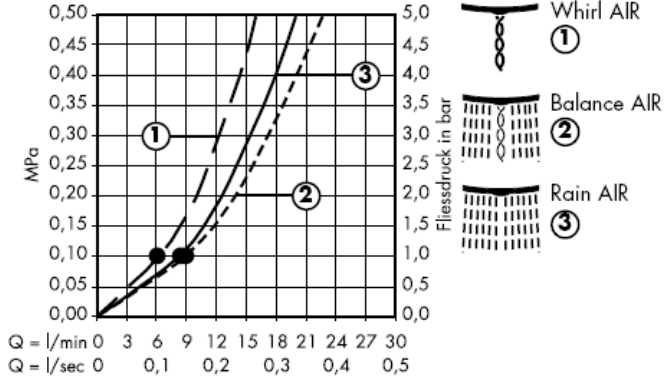

Mit Siebdichtung (B)

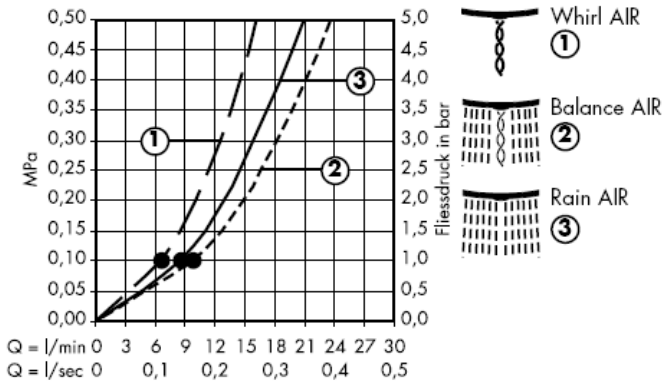

Ab • ist die Funktion gewährleistet.

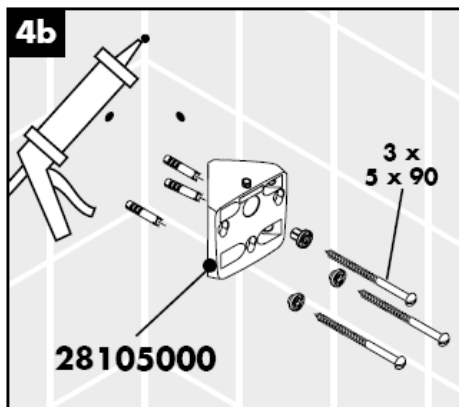
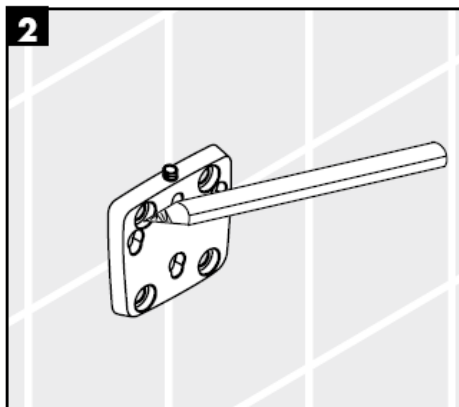

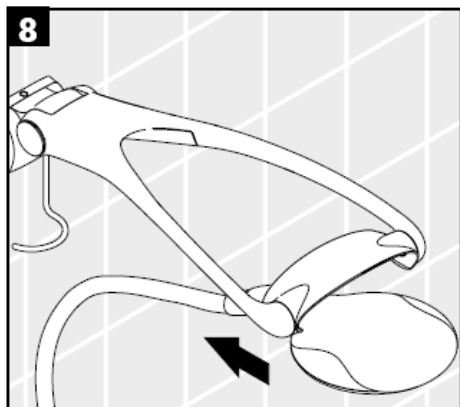
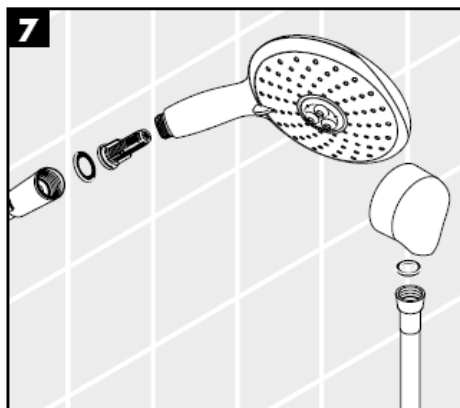
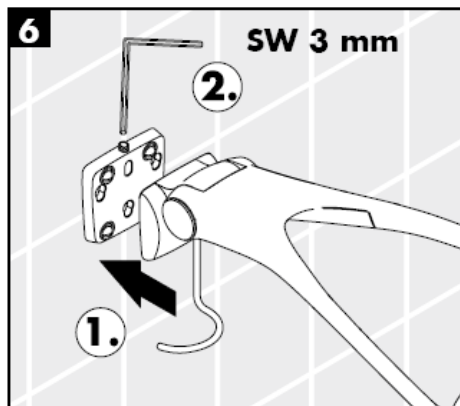
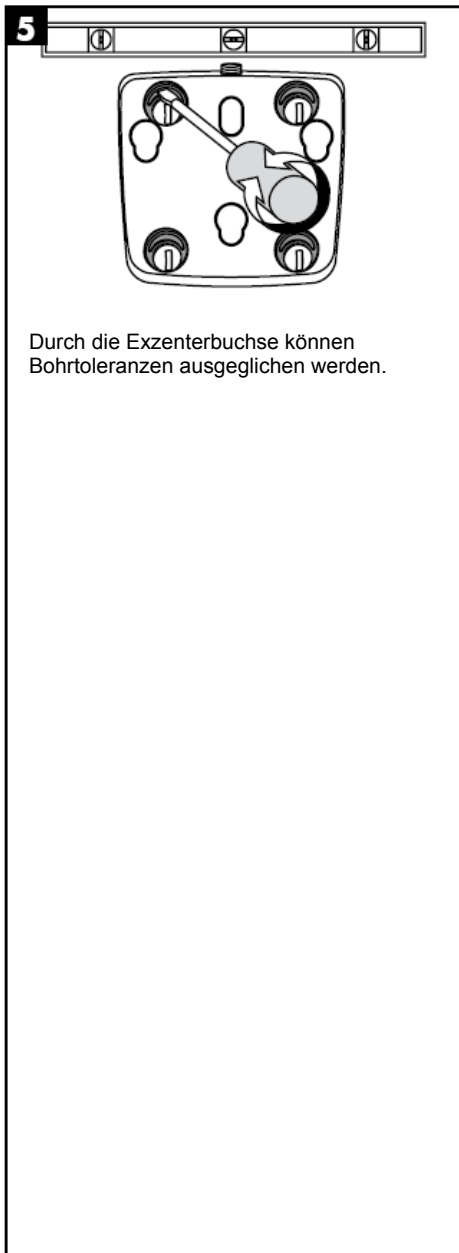

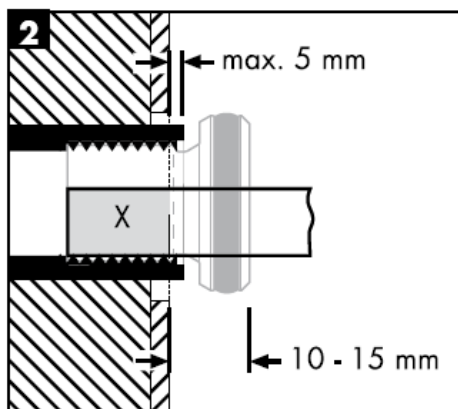
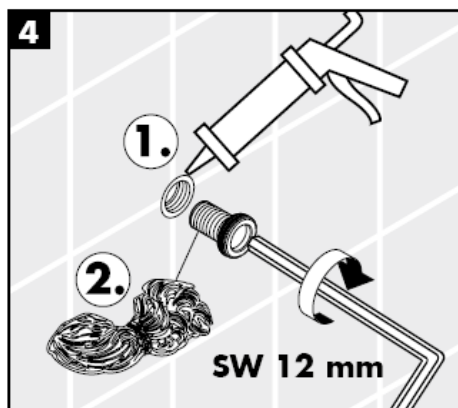
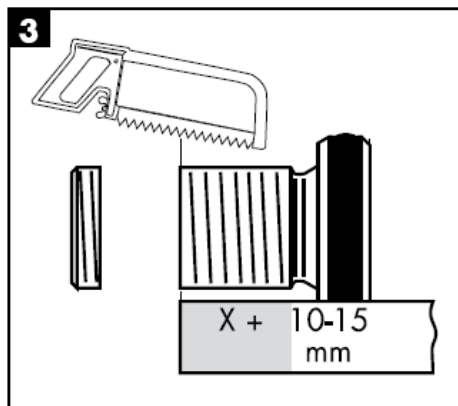
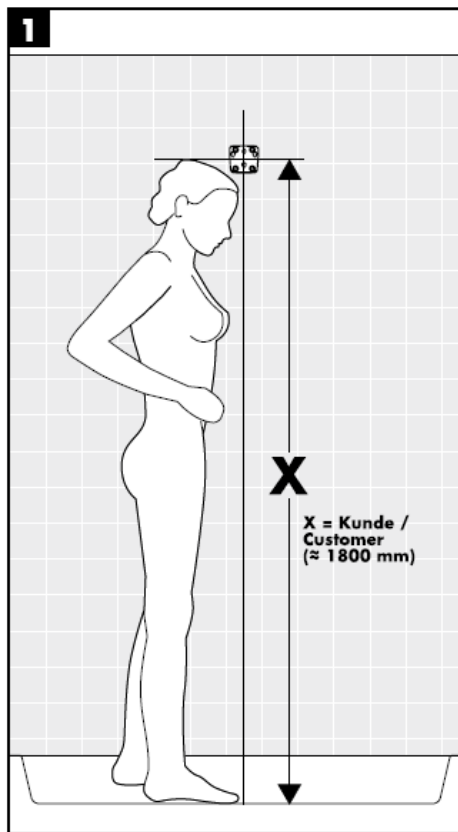

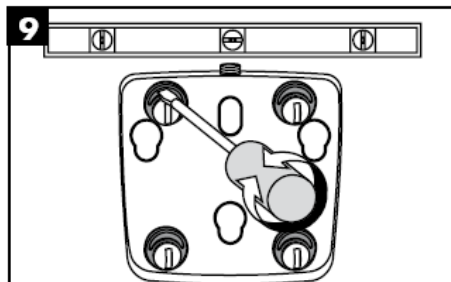
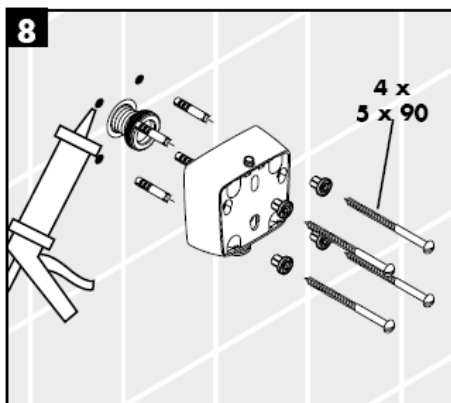
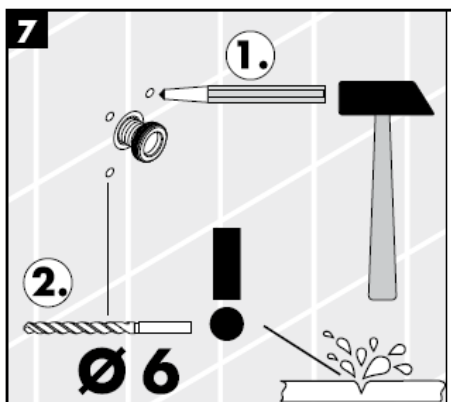
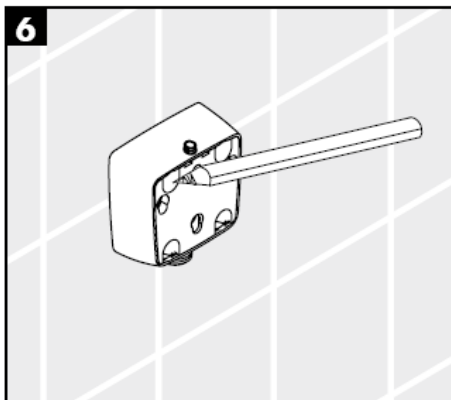

Durch die Exzenterbuchse können Bohrtoleranzen ausgeglichen werden.





Das Allrounder Set ist ein multifunktionales Brausensystem. Je nach Bügelstellung können Kopf- oder Seitenbrausenfunktionen bzw. separate Handbrause genutzt werden.

Einjustieren

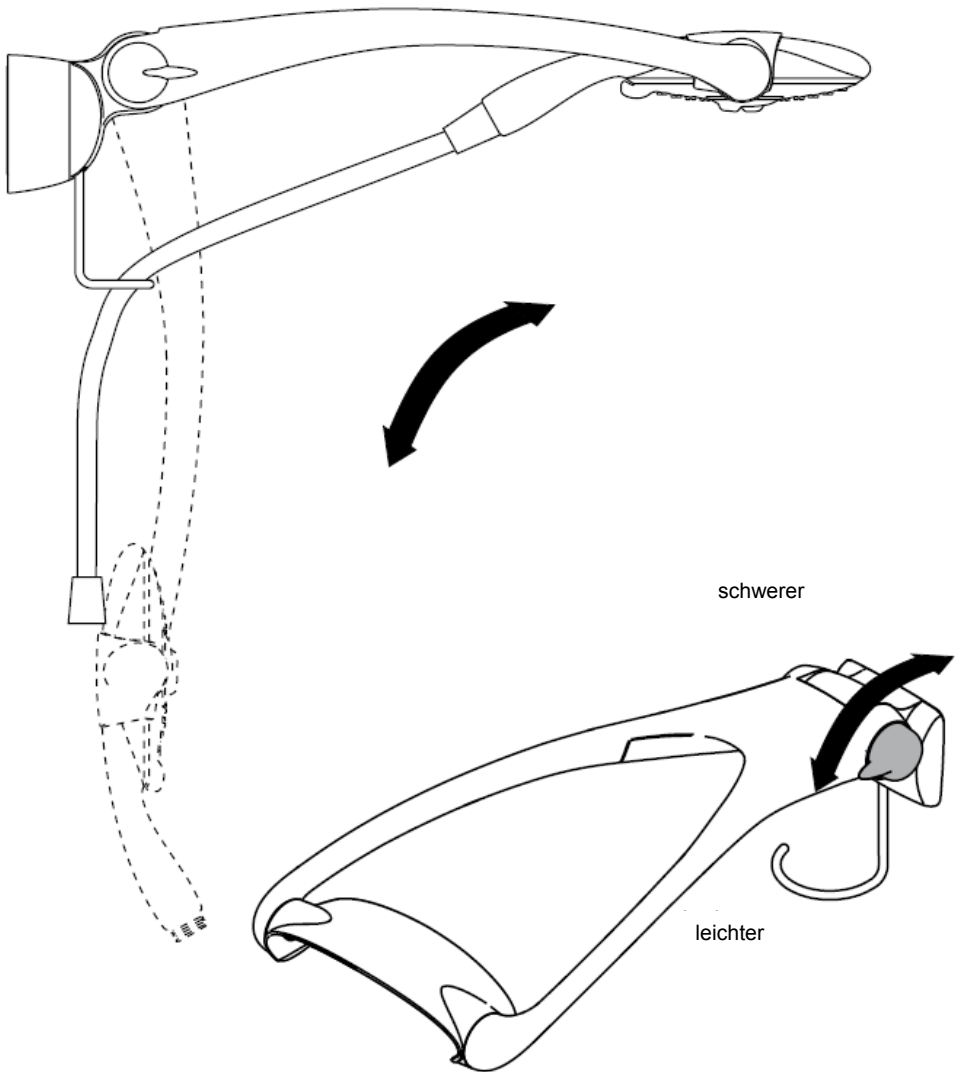

Reinigung

Mit Rubit®, der manuellen Reinigungsfunktion können die Strahlformer durch einfaches rubbeln vom Kalk befreit werden.

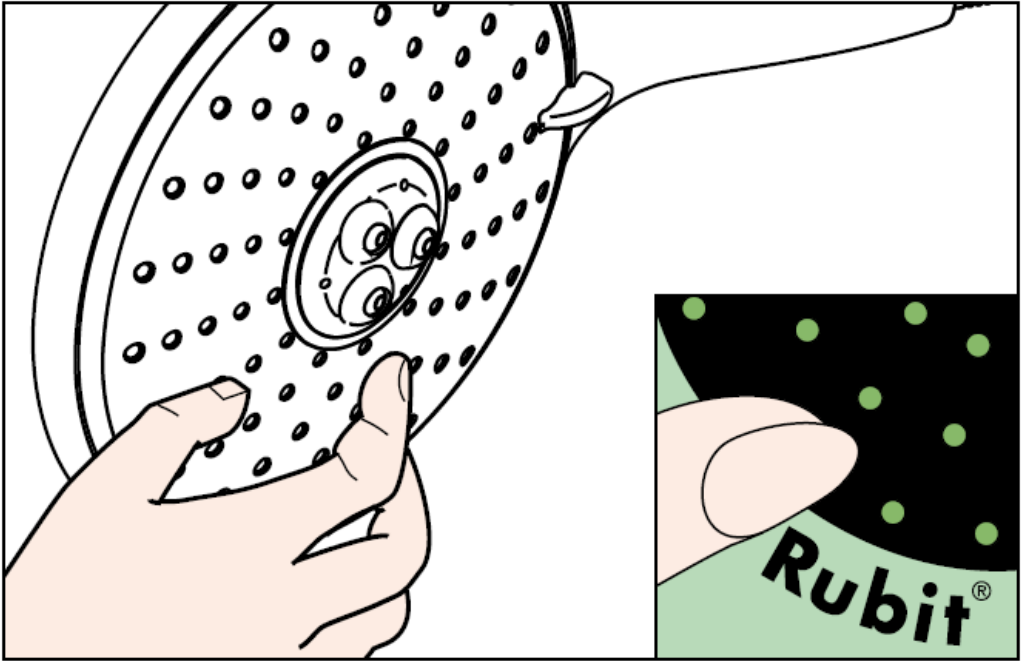

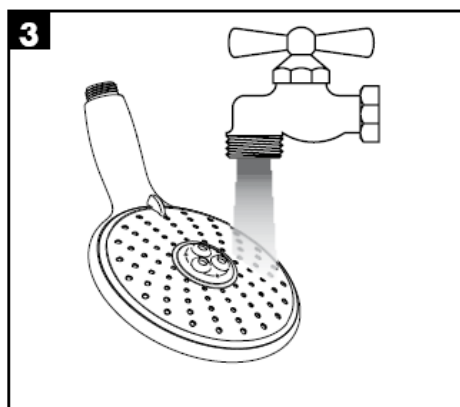
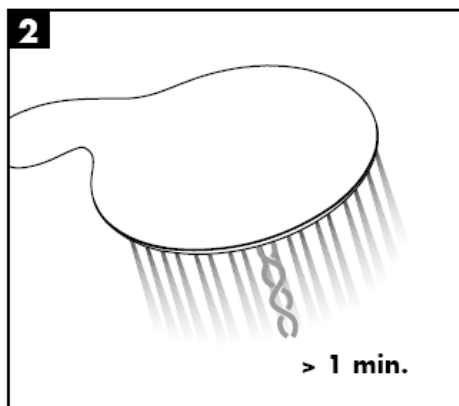
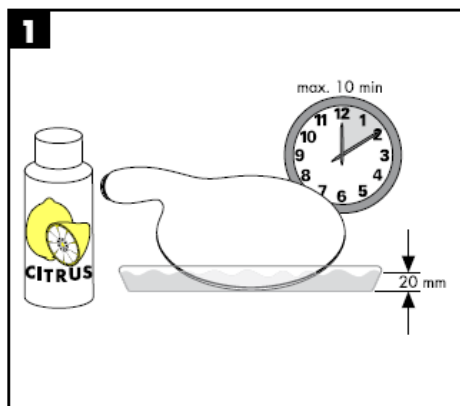

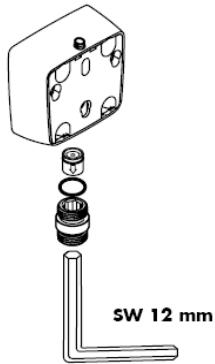

Achtung!

Die Rückflussverhinderer müssen gemäß DIN 1988 einmal jährlich auf ihre Funktion geprüft werden.

hansgrohe

Hansgrohe · Postfach 1145 · D-77761 Schiltach · Telefon +49 (0) 78 36/51-1282 · Telefax +49 (0) 7836/511440
E-Mail: info@hansgrohe.com · Internet: www.hansgrohe.com

02/2008
9.06081.04
Deutsch

Instructions de montage

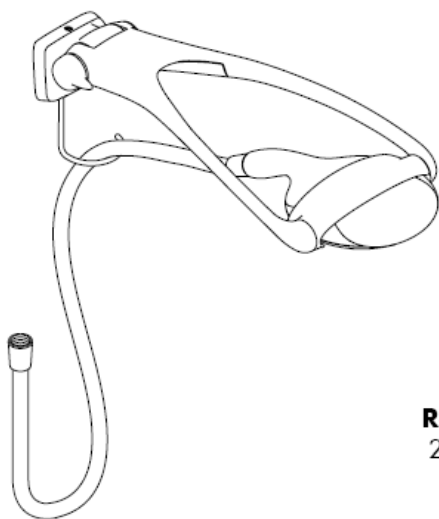

Raindance
28105000

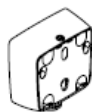

Raindance
28108000

Raindance Allrounder Set
28100000 / 28110000

hansgrohe

Raindance Allrounder Set

28100000 / 28110000

Classification acoustique et débit 28110000: ACS

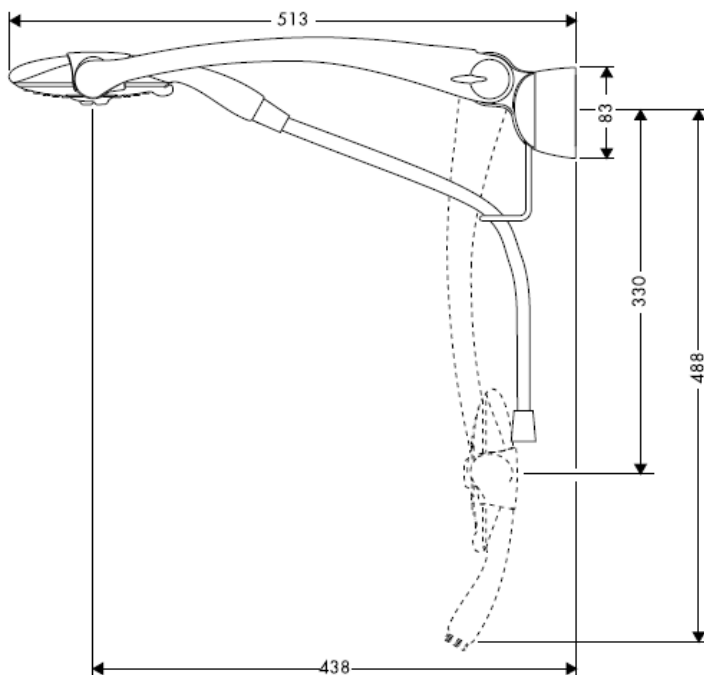

Raindance Eckmontage Set

28105000



Raindance UP-Adapter für Schlauchanschluß

28108000



Raindance Allrounder Set

28100000 / 28110000

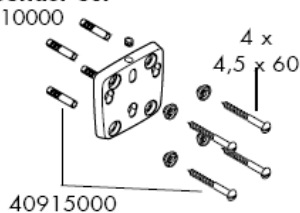

98562000

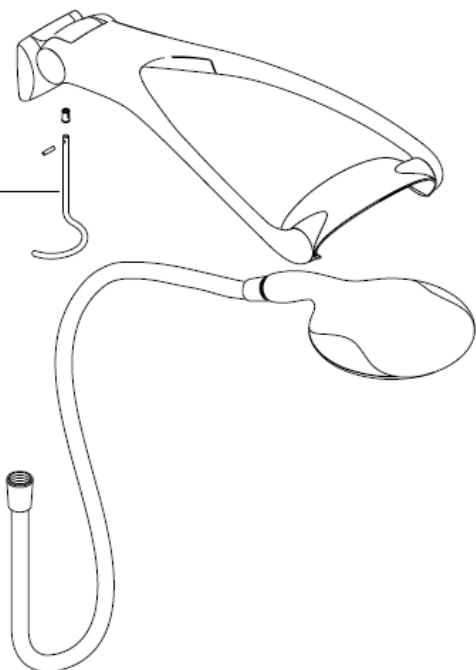

Raindance Eckmontage Set

28105000

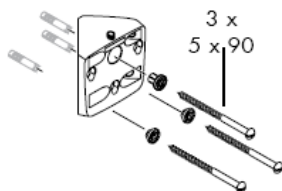

Raindance UP-Adapter für Schlauchanschluss

28108000

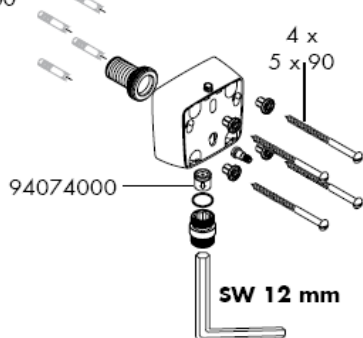

Montage

L'élément-filtre (A), pièce jointe, doit être installé pour garantir le débit normalisé et pour éviter l'infiltration d'impuretés venant du réseau. Si l'on désire un débit plus important, il faut remplacer l'élément-filtre (A) par le joint-filtre (B).

L'infiltration d'impuretés peut réduire ou détériorer le fonctionnement de la douchette, Hansgrohe ne se porte pas garant pour les dommages en résultant.

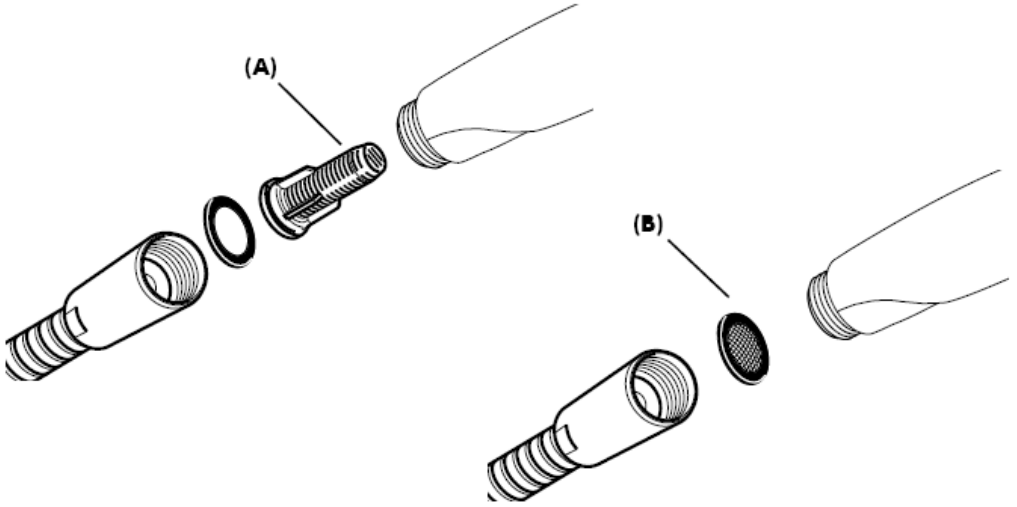

Avec élément-filtre (A)

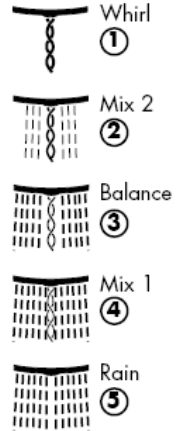
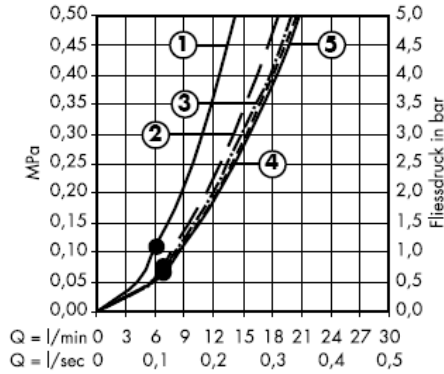

Avec joint- filtre (B)

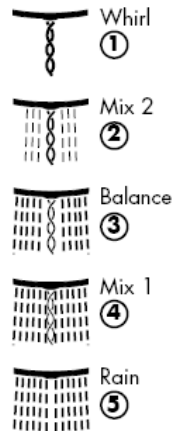
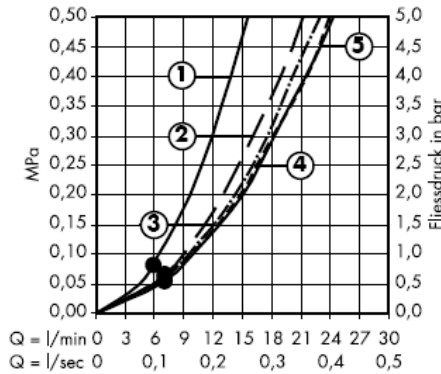

A partir de • le fonctionnement est garanti.

Avec élément-filtre (A)

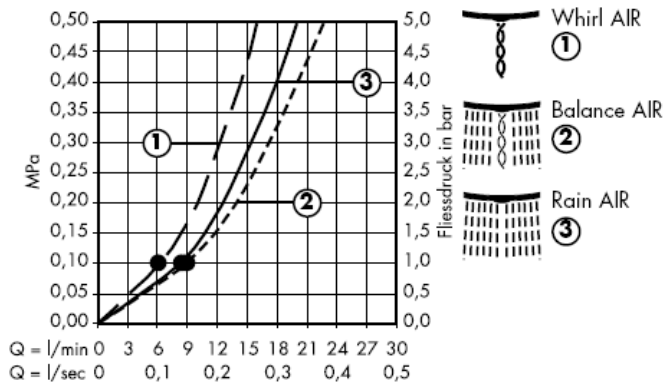

Avec joint- filtre (B)

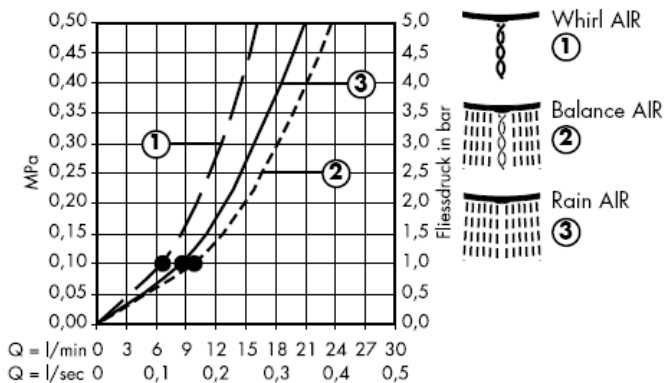

A partir de • le fonctionnement est garanti.

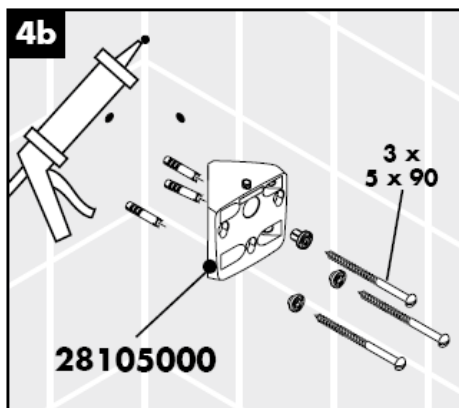
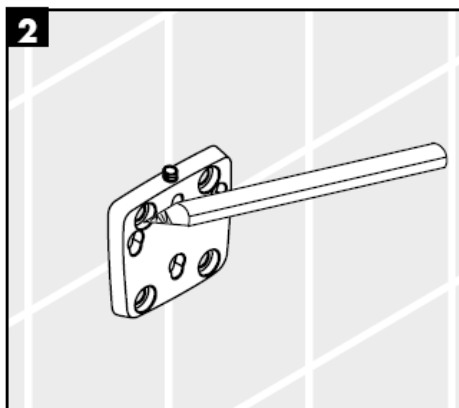

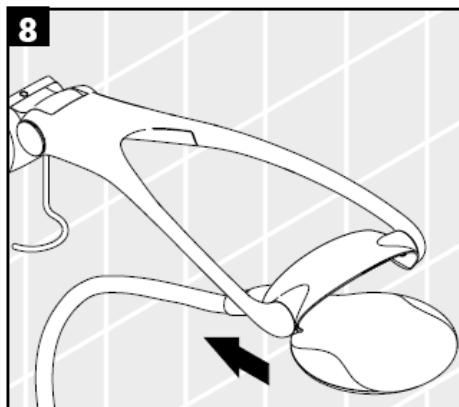
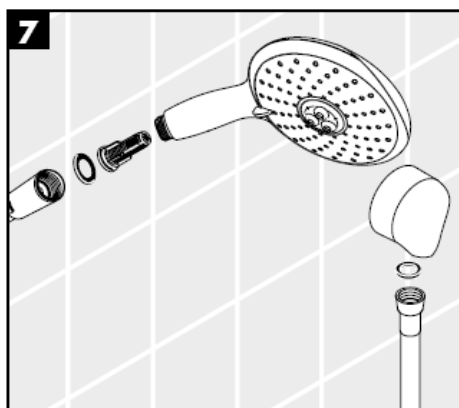
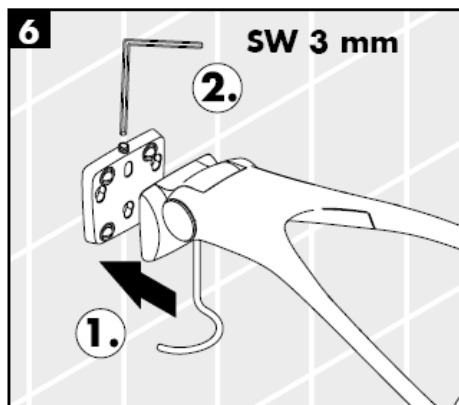

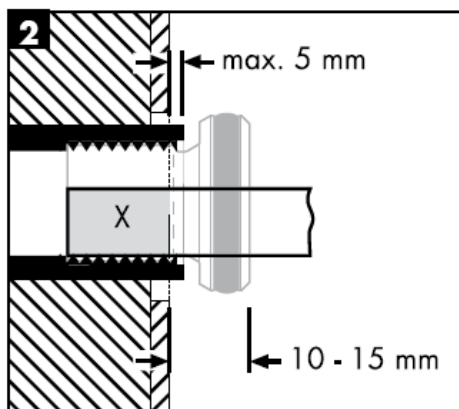
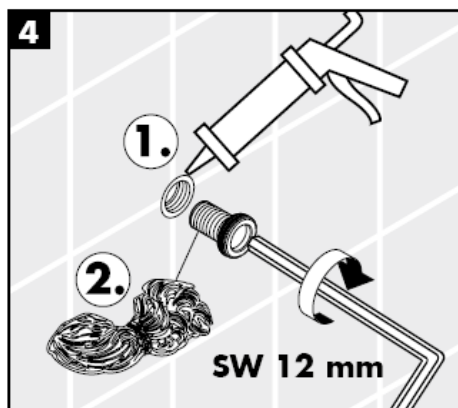
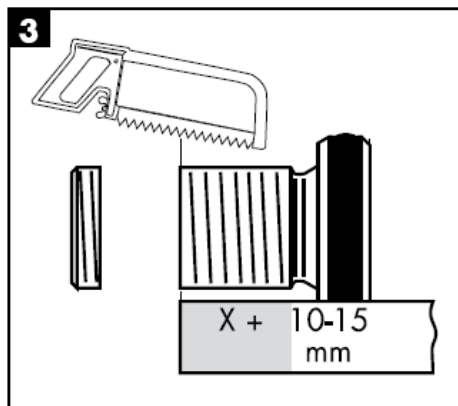
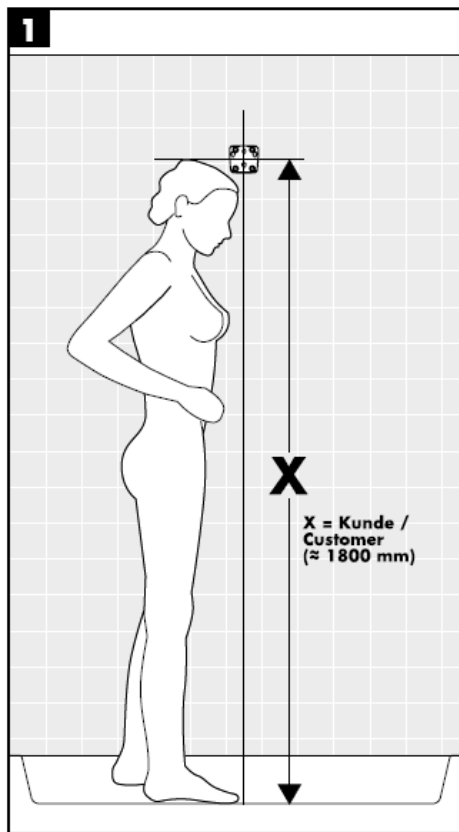

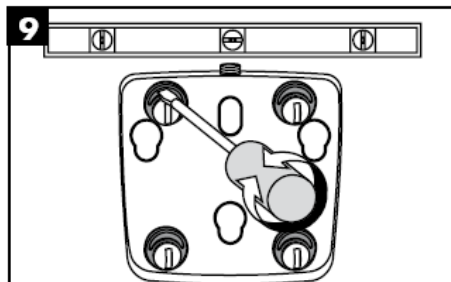
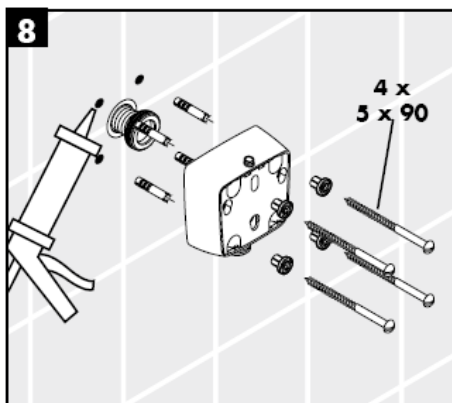
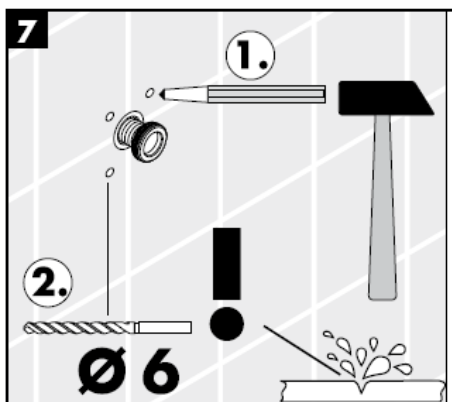
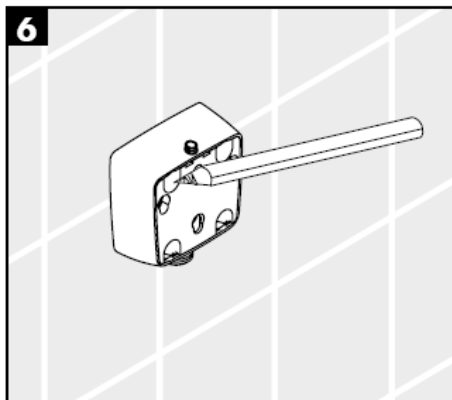

Grâce à l'axe excentrique de réglage on peut rattraper la tolérance de perçage.





Le set Allrounder est un système de douche multifonctions. Suivant la position du bras il offre au choix, la douche de tête, la douche latérale ou la douchette à main.

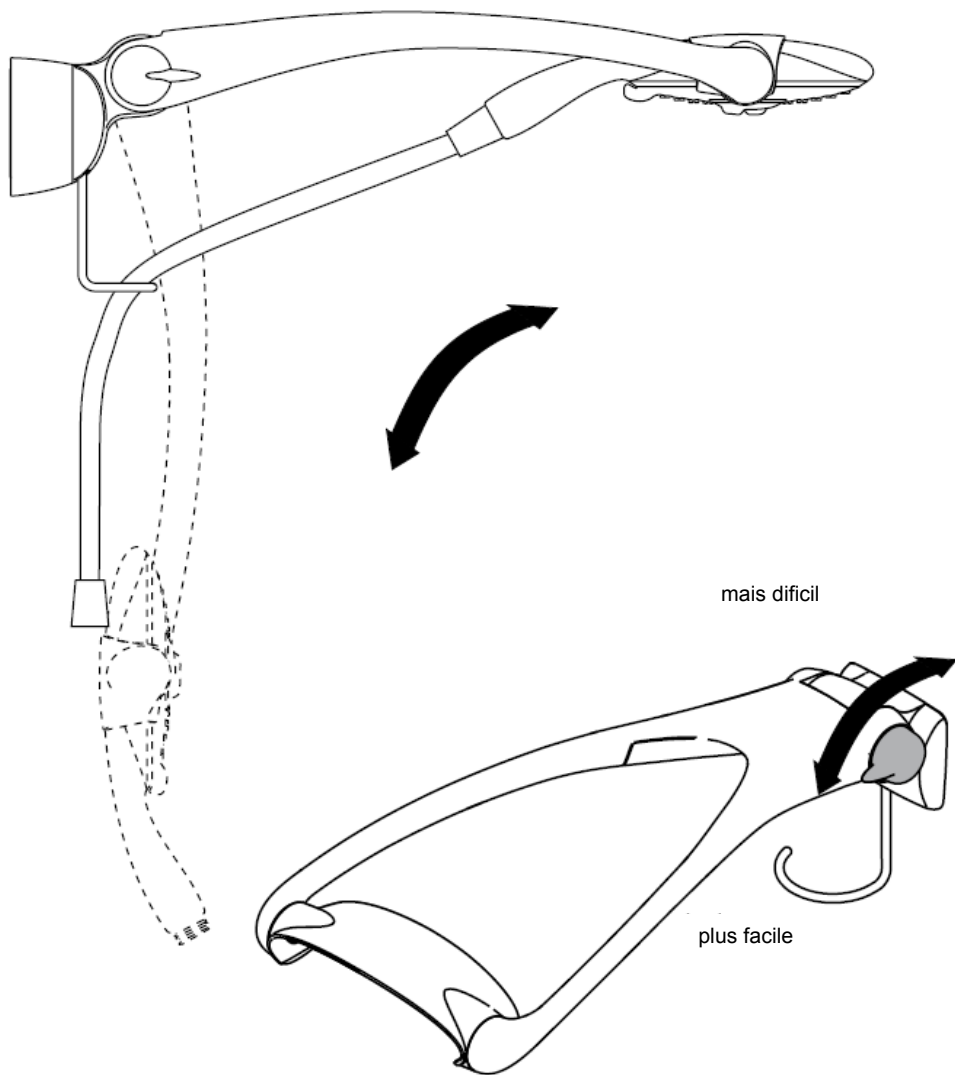

Nettoyage

La pomme de douche est équipée de Rubit®, le système anticalcaire manuel. Les dépôts de calcaire s'enlèvent en frottant avec un doigt ou avec une éponge sur les ouvertures de jets élastiques.

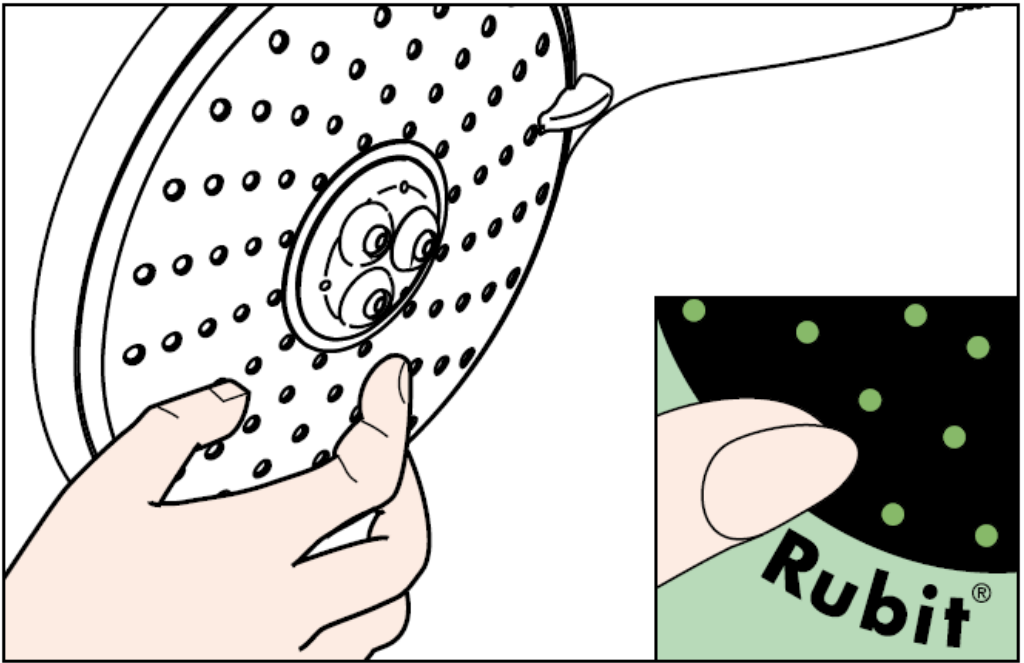

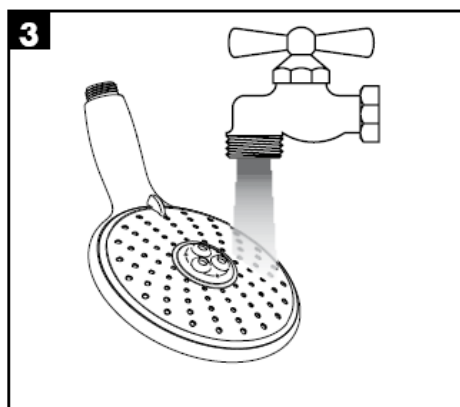
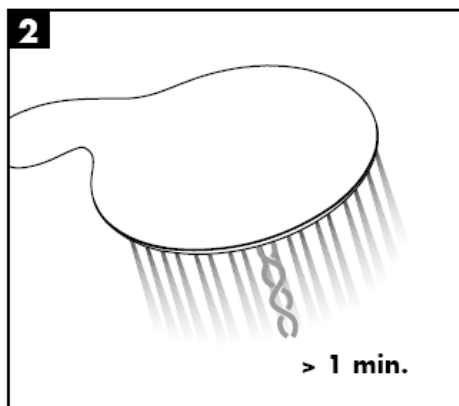
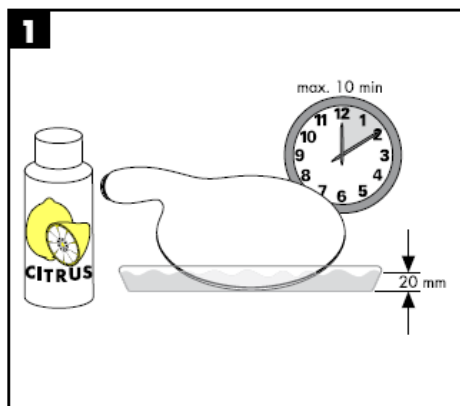

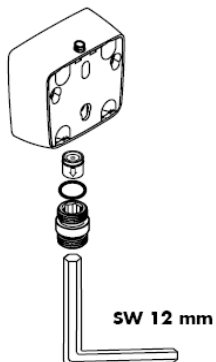

Attention!

Les clapets anti-retour doivent être vérifiés une fois par an.

hansgrohe

Hansgrohe · Postfach 1145 · D-77761 Schiltach · Telefon +49 (0) 78 36/51-1282 · Telefax +49 (0) 7836/511440
E-Mail: info@hansgrohe.com · Internet: www.hansgrohe.com

02/2008
9.06081.04
Français

assembly instructions

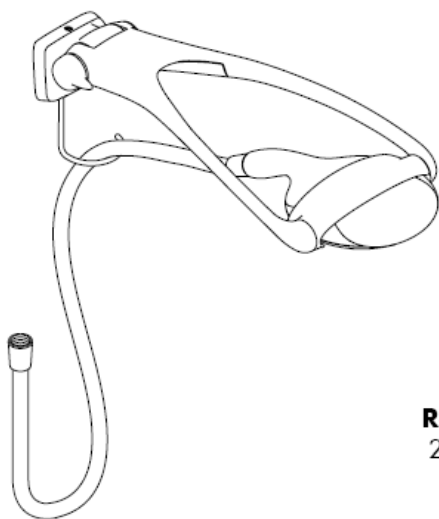

Raindance
28105000

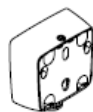

Raindance
28108000

Raindance Allrounder Set
28100000 / 28110000

hangrohe

Raindance Allrounder Set

28100000 / 28110000

Classification acoustique et débit 28110000: ACS

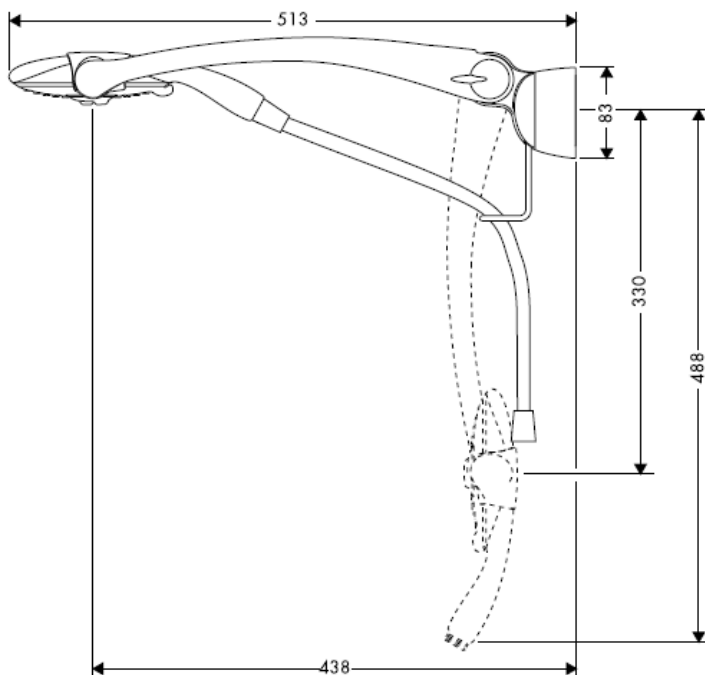

Raindance Eckmontage Set

28105000



Raindance UP-Adapter für Schlauchanschluß

28108000



Raindance Allrounder Set

28100000 / 28110000

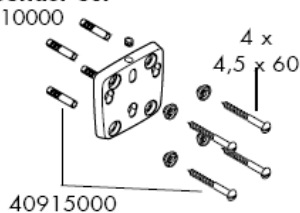

98562000

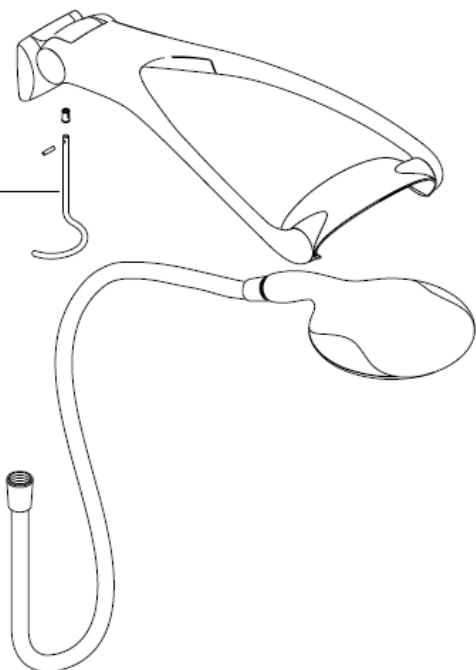

Raindance Eckmontage Set

28105000

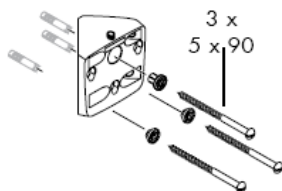

Raindance UP-Adapter für Schlauchanschluss

28108000

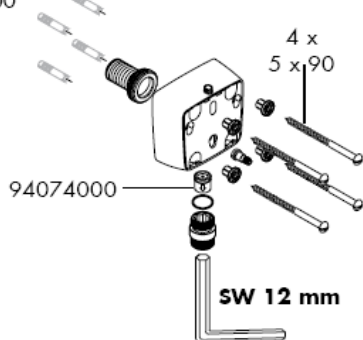

Assembly

The filter insert (A) must be used to ensure the standard flow rate and to protect the hand shower against incoming dirt by pipework. Do you want a larger water flow rate, then you must use the filter packing (B) instead of the filter insert (A).

Incoming dirt leads to defects or/and can damage parts of the hand shower; such caused faults voids all liability and guarantee claims.

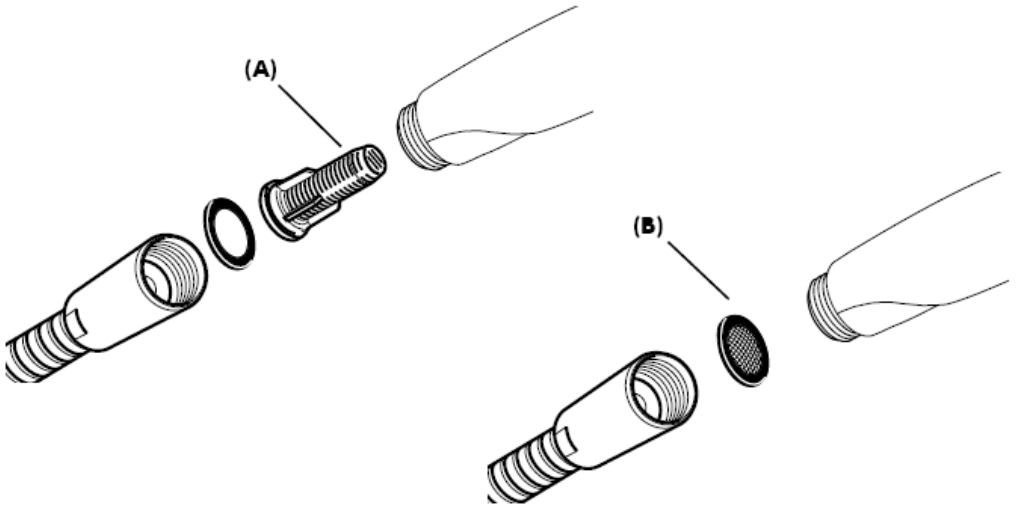

281000000

With filter insert (A)

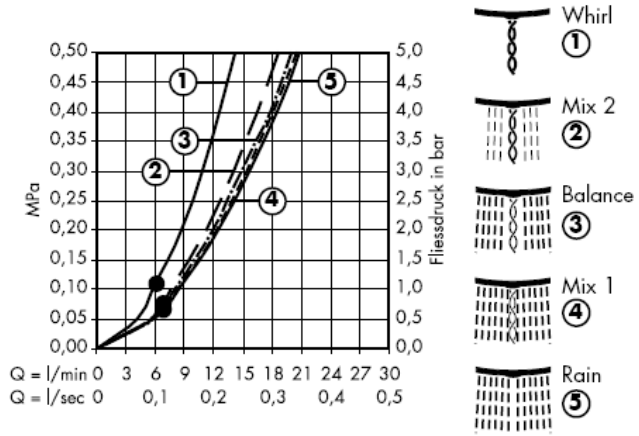

With filter packing (B)

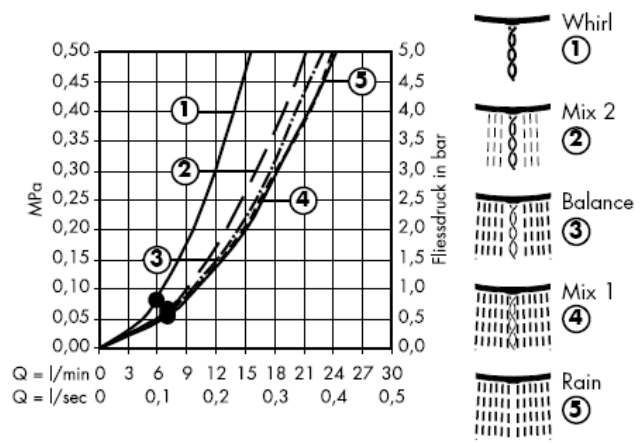

From • the function is guaranteed.

With filter insert (A)

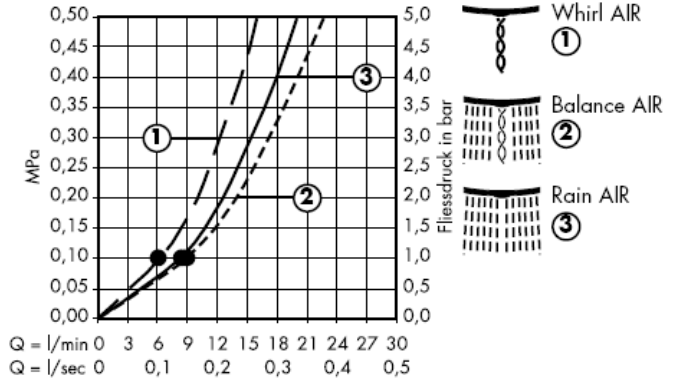

With filter packing (B)

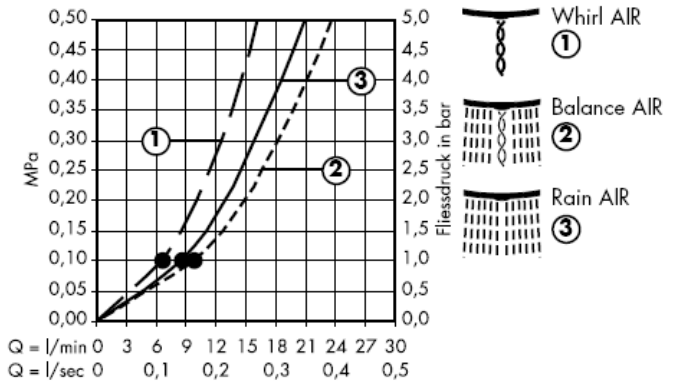

From • the function is guaranteed.

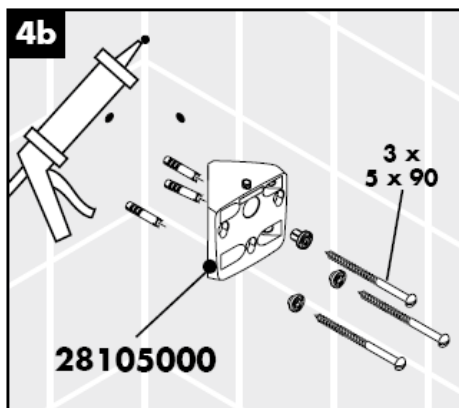
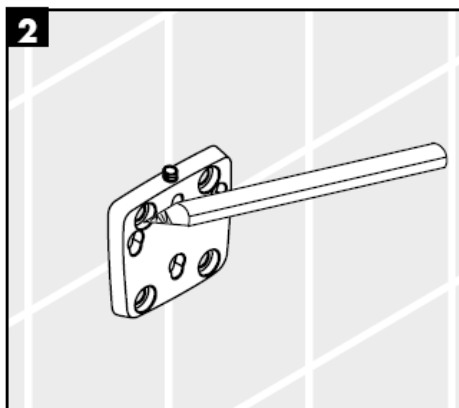

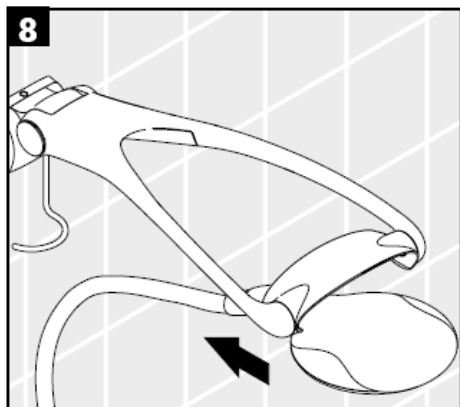
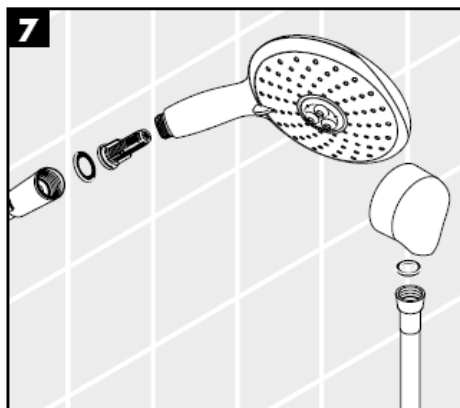
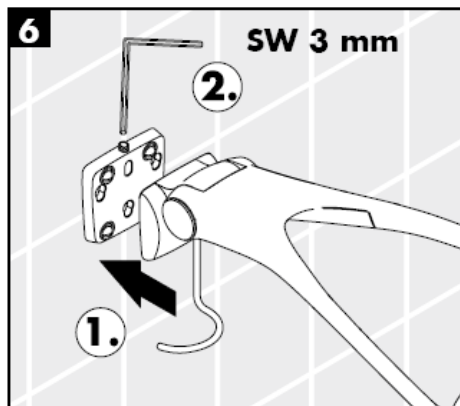
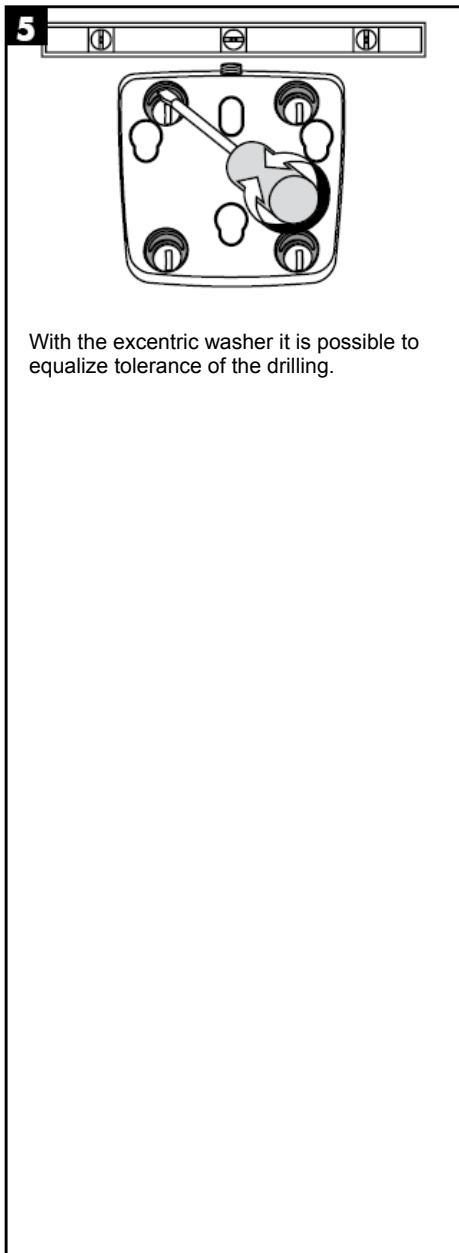

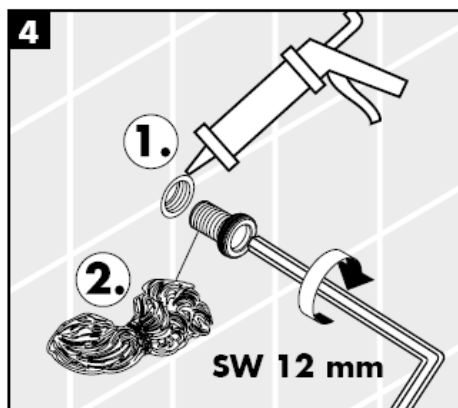
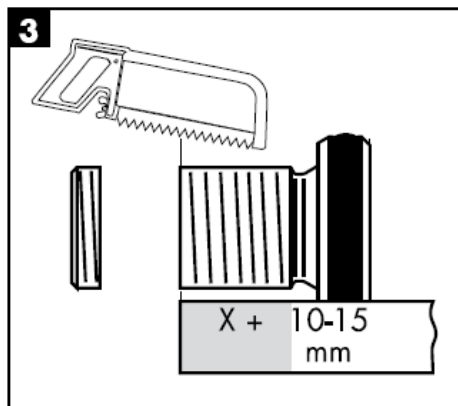
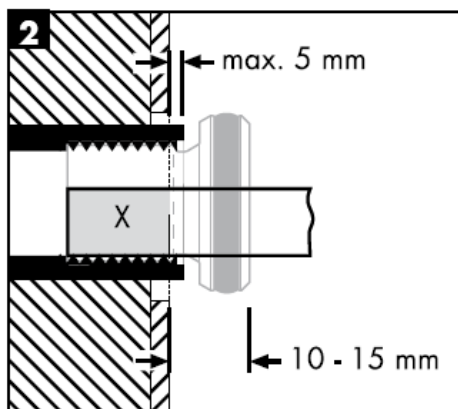
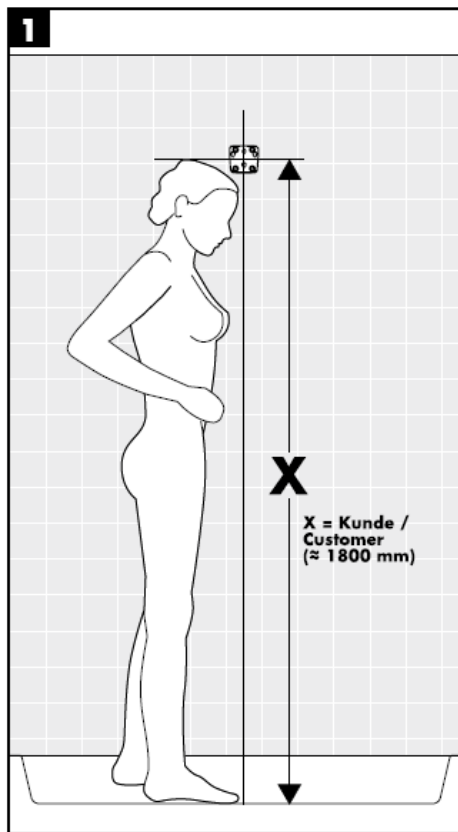

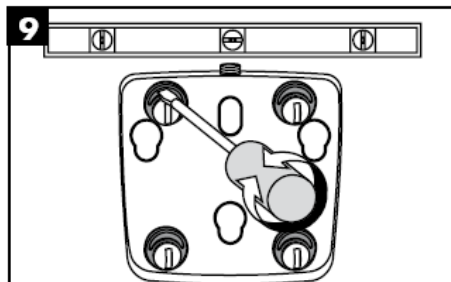
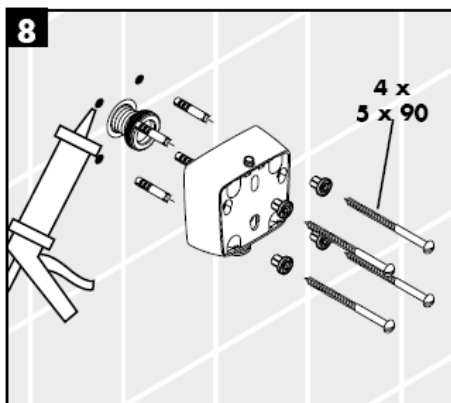
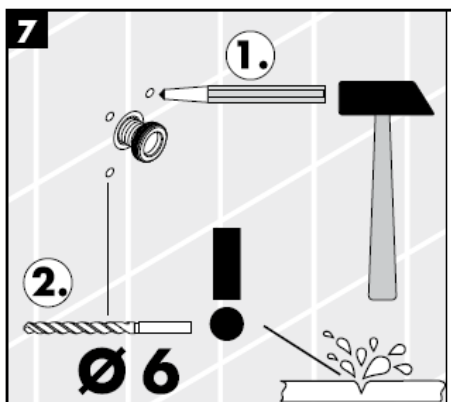
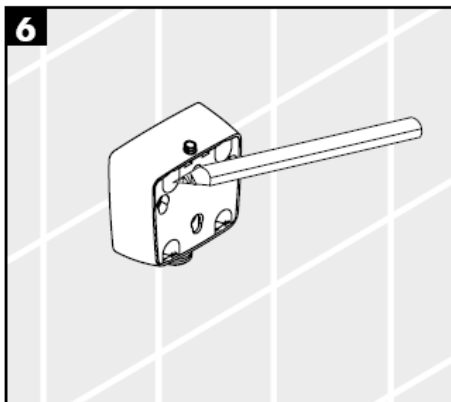

With the excentric washer it is possible to equalize tolerance of the drilling.

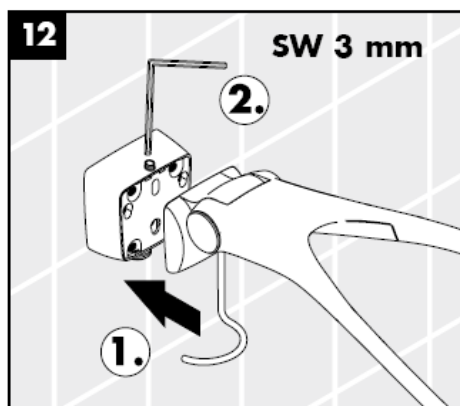
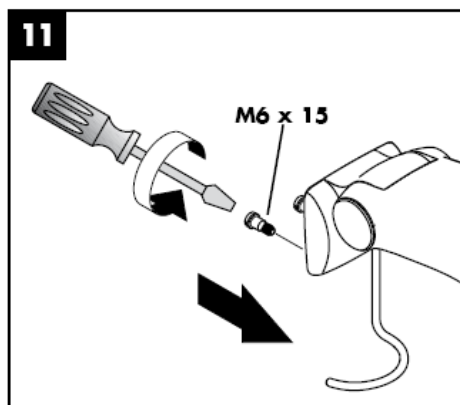
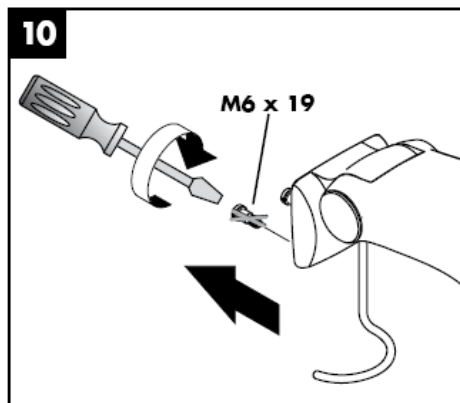

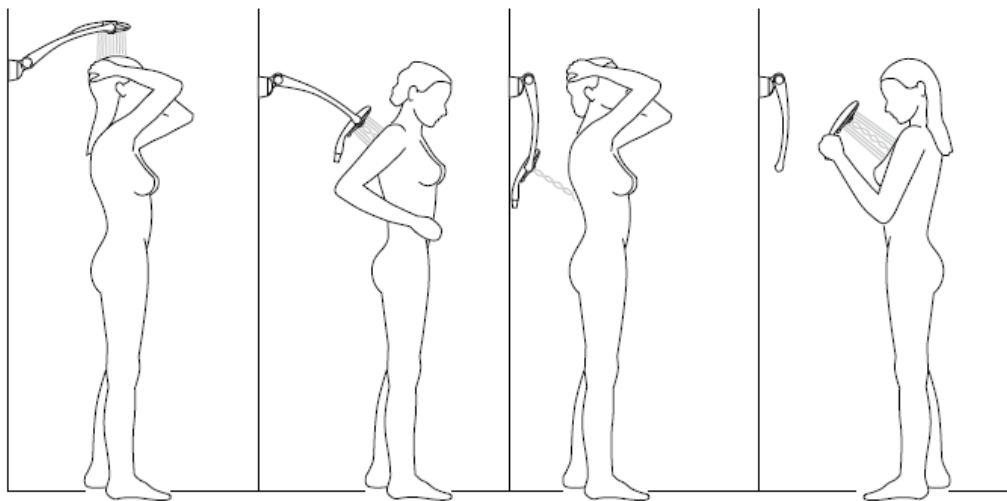

The Allrounder set is a multi function shower system. Overhead, body showers, or separate hand shower can be used according to lever position.

Adjustment

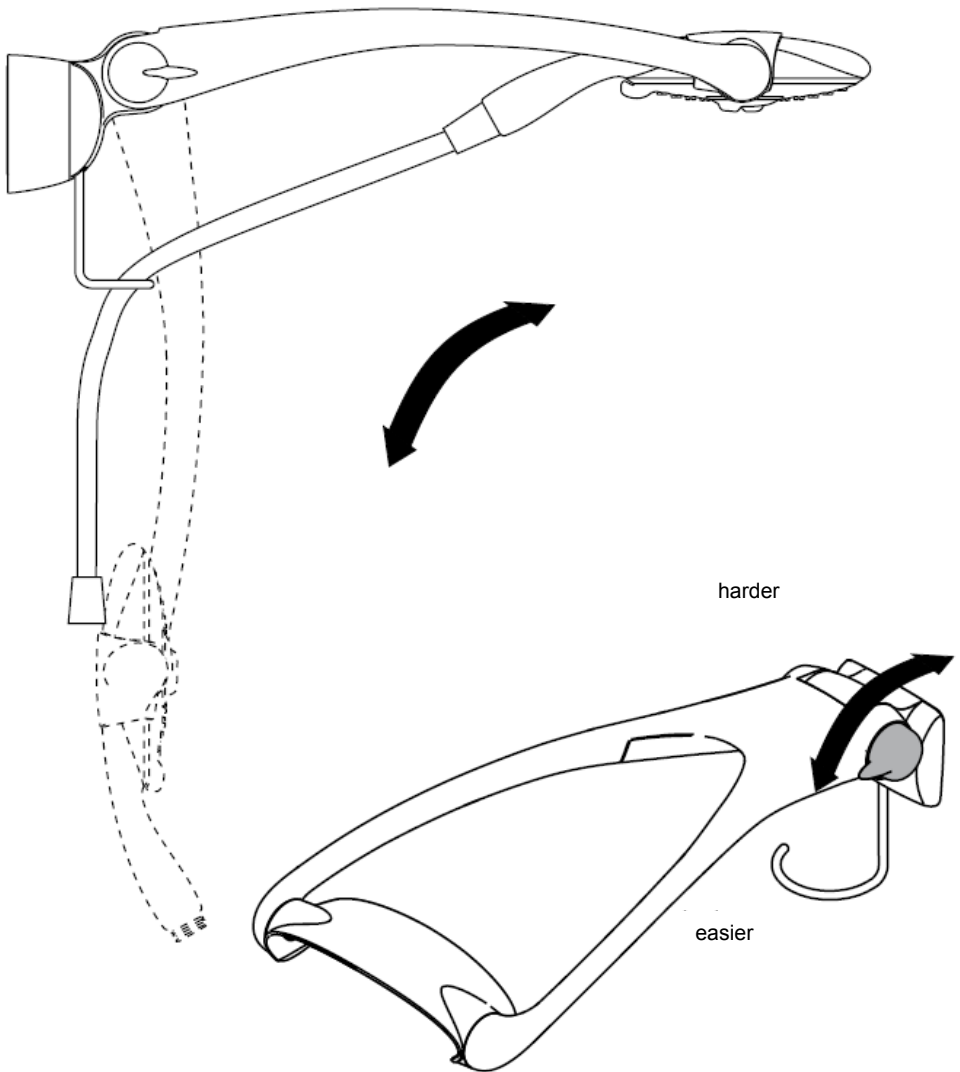

Cleaning

The Rubit® cleaning function only needs a small manual rub over to remove the lime scale from the spray channels.

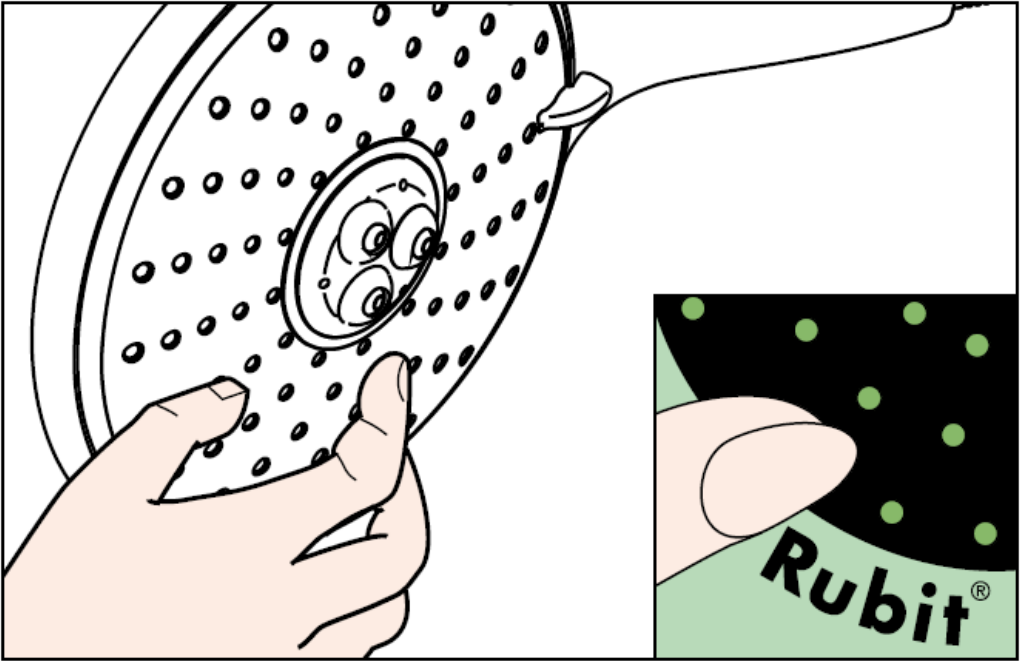

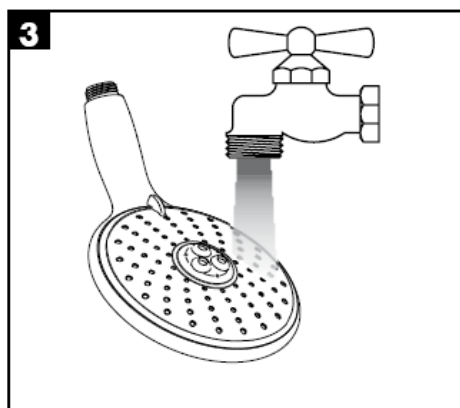
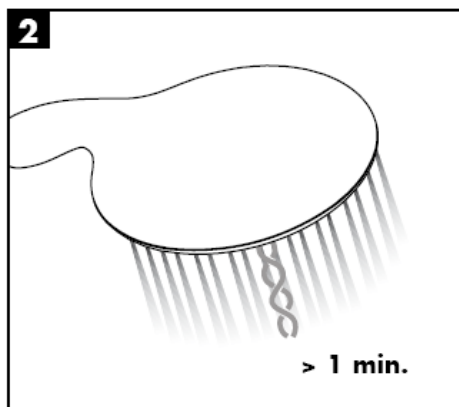
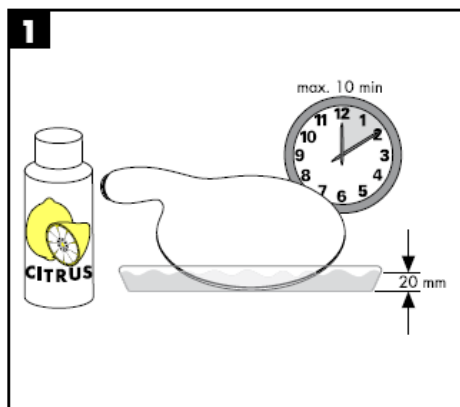

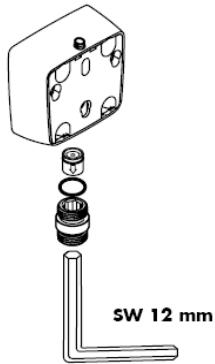

Important!

The non return valves must be checked once a year.

hansgrohe

Istruzioni per Installazione

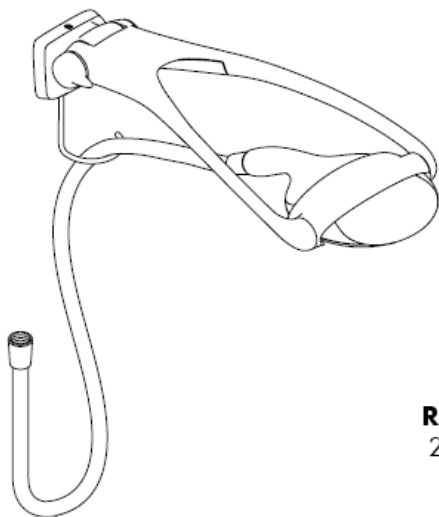

Raindance
28105000

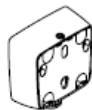

Raindance
28108000

Raindance Allrounder Set
28100000 / 28110000

hansgrohe

Raindance Allrounder Set

28100000 / 28110000

Classification acoustique et débit 28110000: ACS

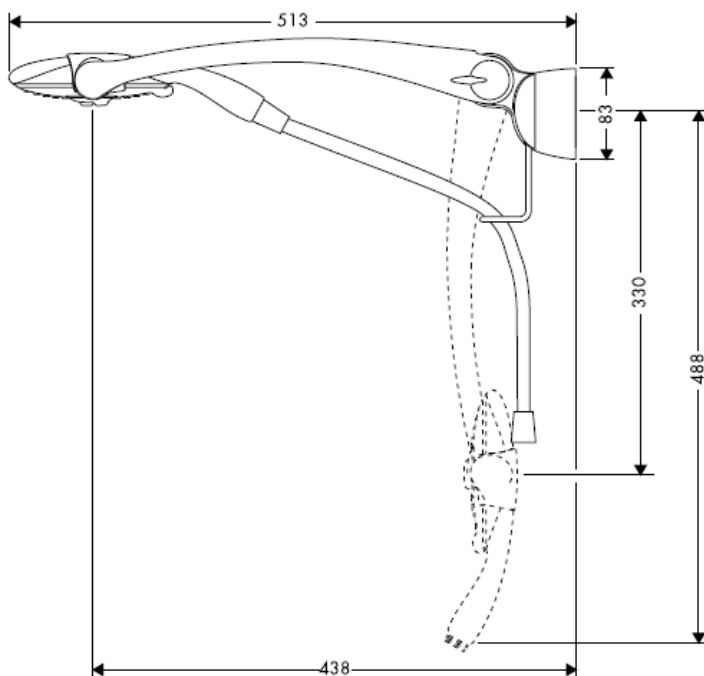

Raindance Eckmontage Set

28105000



Raindance UP-Adapter für Schlauchanschluß

28108000



Raindance Allrounder Set

28100000 / 28110000

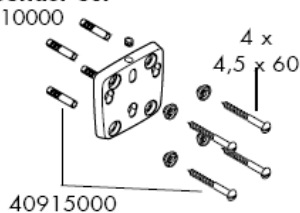

98562000

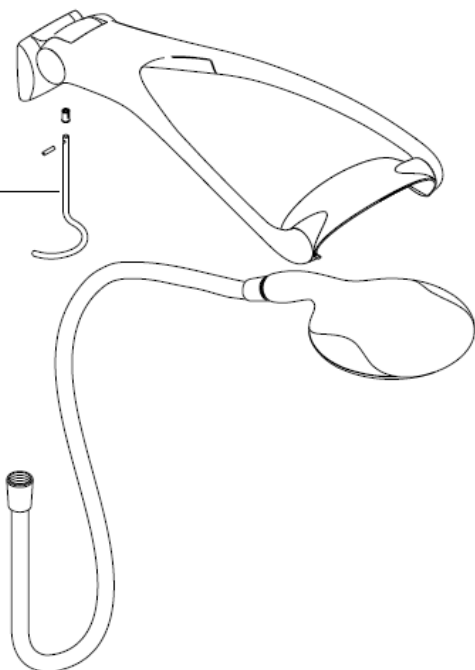

Raindance Eckmontage Set

28105000

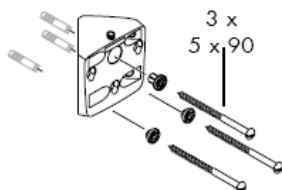

Raindance UP-Adapter für Schlauchanschluss

28108000

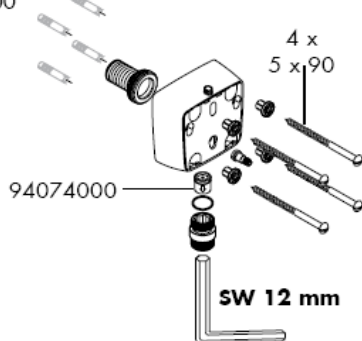

Montaggio

Il filtro supplementare (A) deve essere utilizzato per assicurare il normale flusso dell'acqua e proteggere la doccia dai depositi di calcare.
Se volete un flusso d'acqua maggiore dovete usare il filtro dell'imballaggio(B) invece del filtro supplementare(A).
Lo sporco in entrata può danneggiare le parti della doccia; questo é motivo di molte lamentele del cliente.

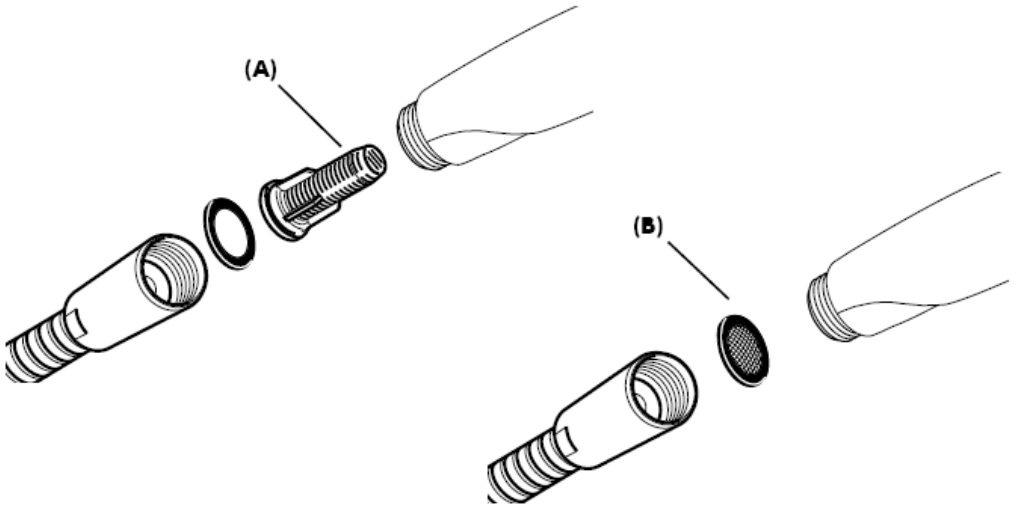

Con filtro supplementare (A)

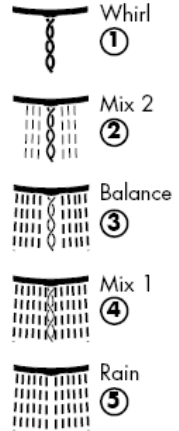
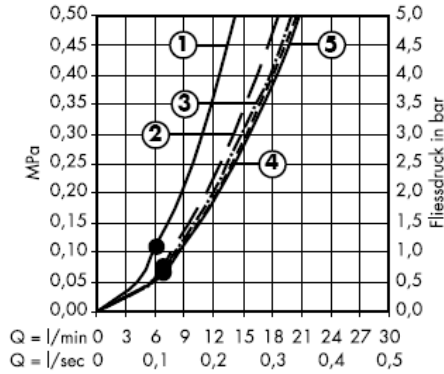

Con filtro di imballaggio

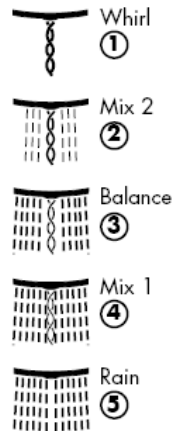
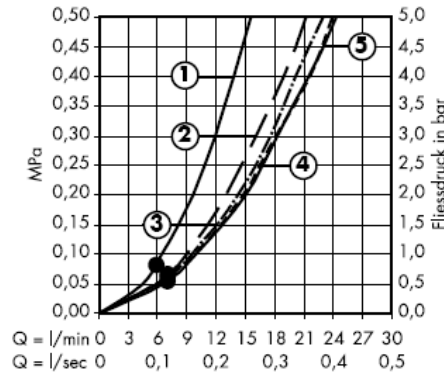

Dal • si garantisce la funzionalità.

Con filtro supplementare (A)

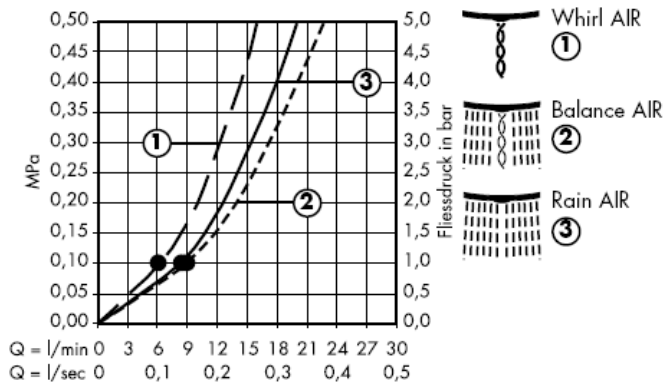

Con filtro di imballaggio

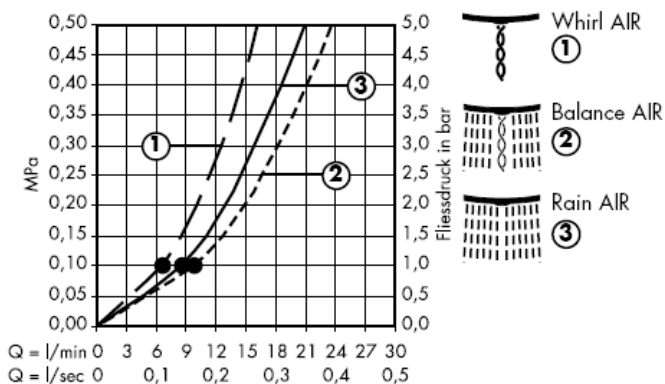

Dal • si garantisce la funzionalità.

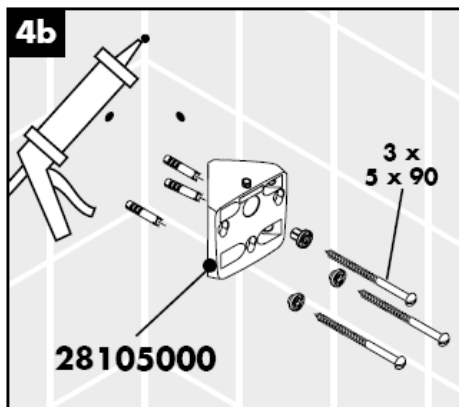
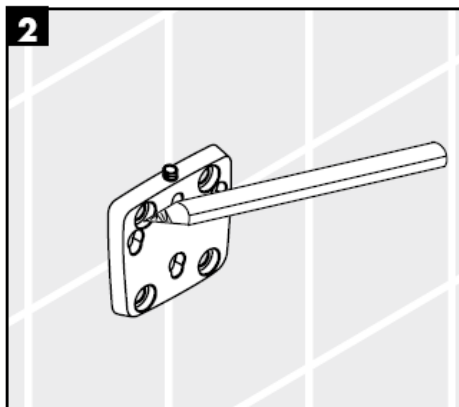
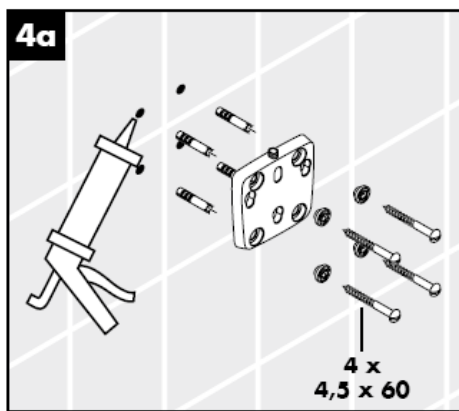
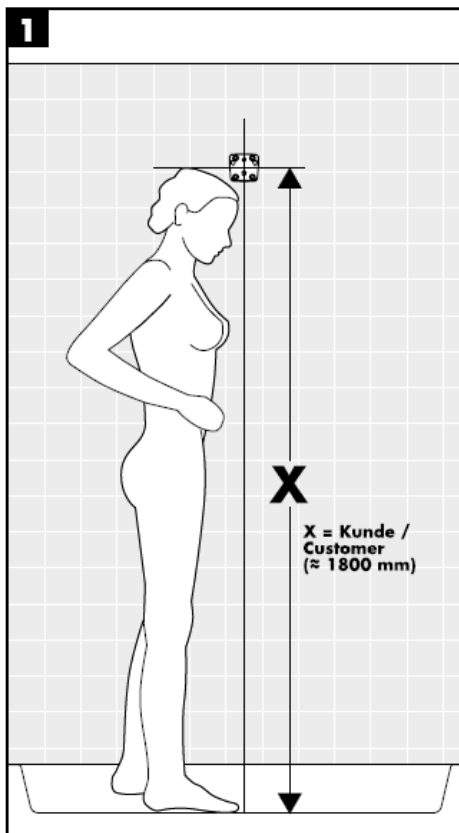

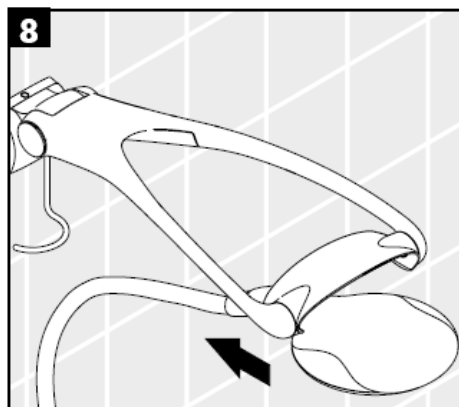
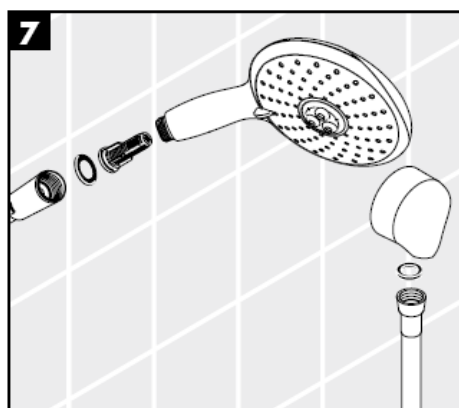
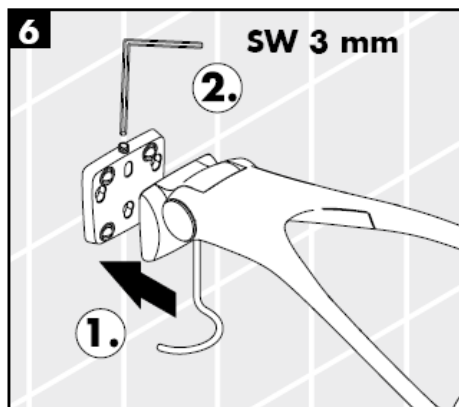

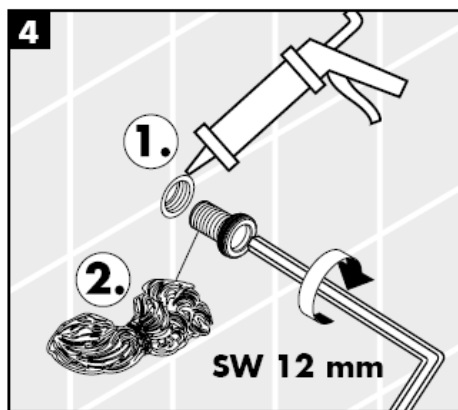
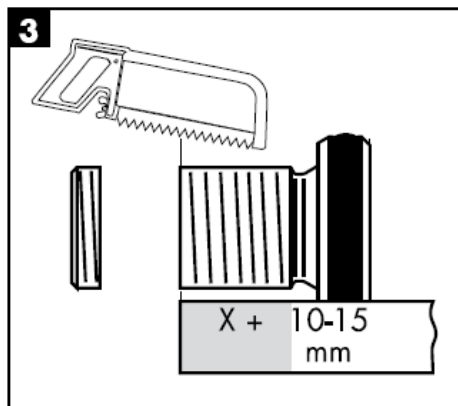
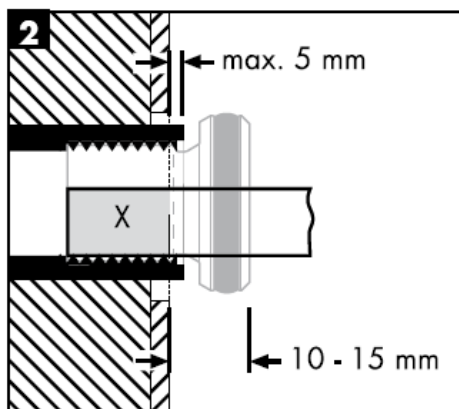
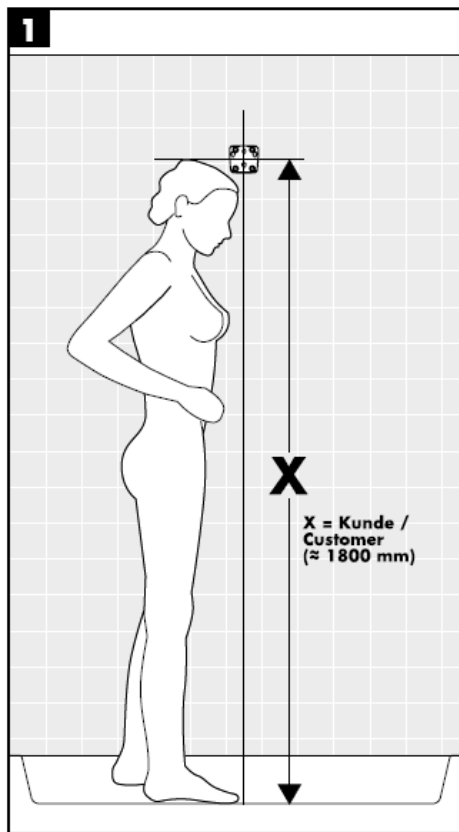

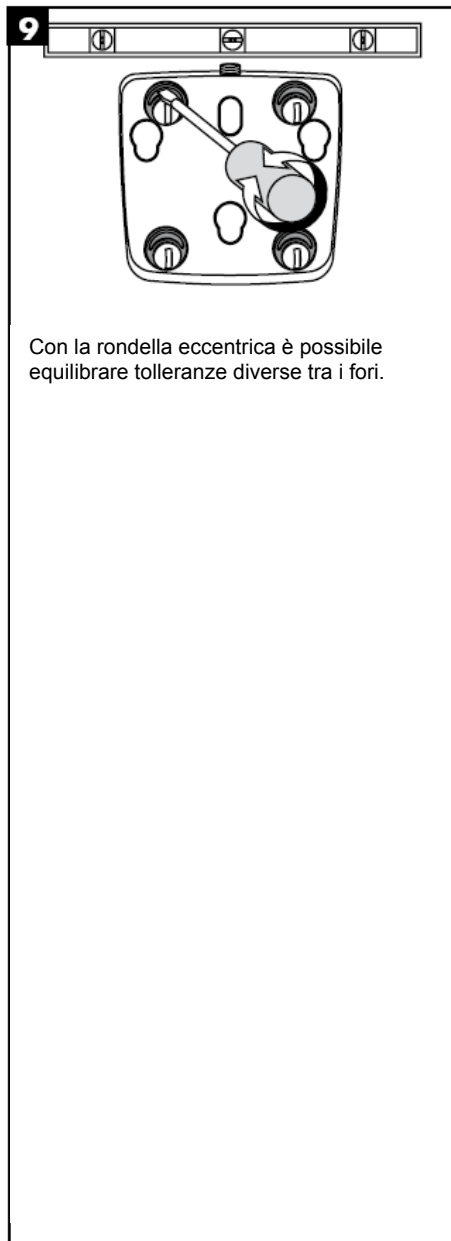
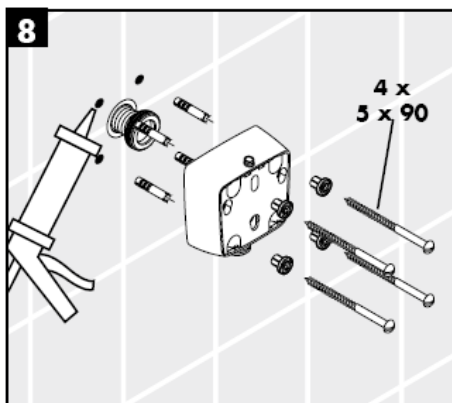
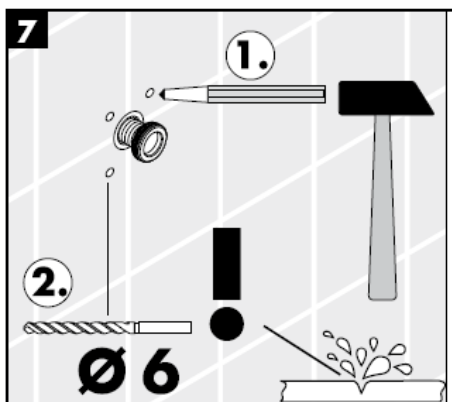
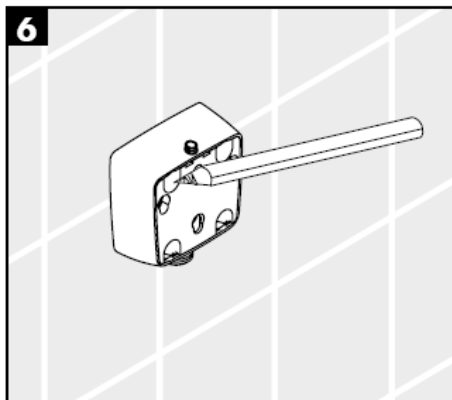



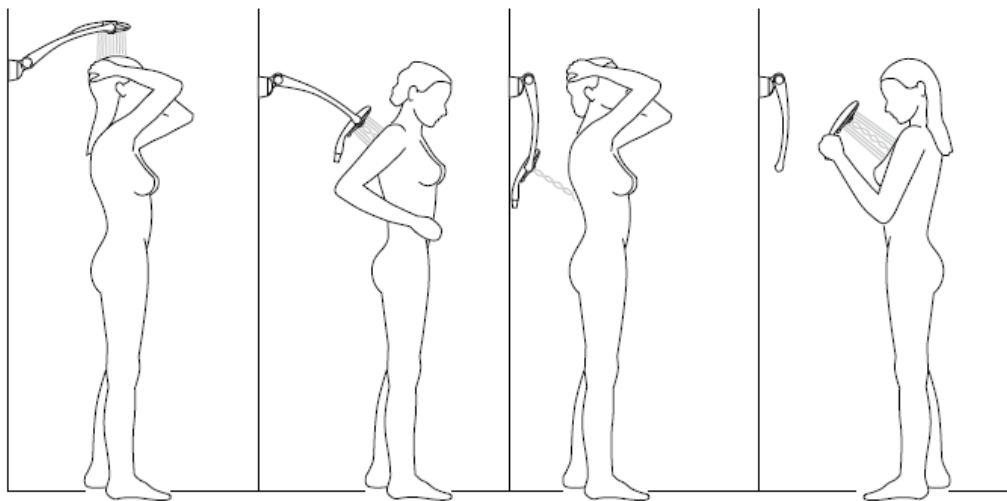

Il Set Allrounder è un sistema doccia multifunzionale che soddisfa ogni necessità: può essere un piacevolissimo soffione doccia, diventare una funzionale doccia laterale ma anche essere separatamente come doccetta.

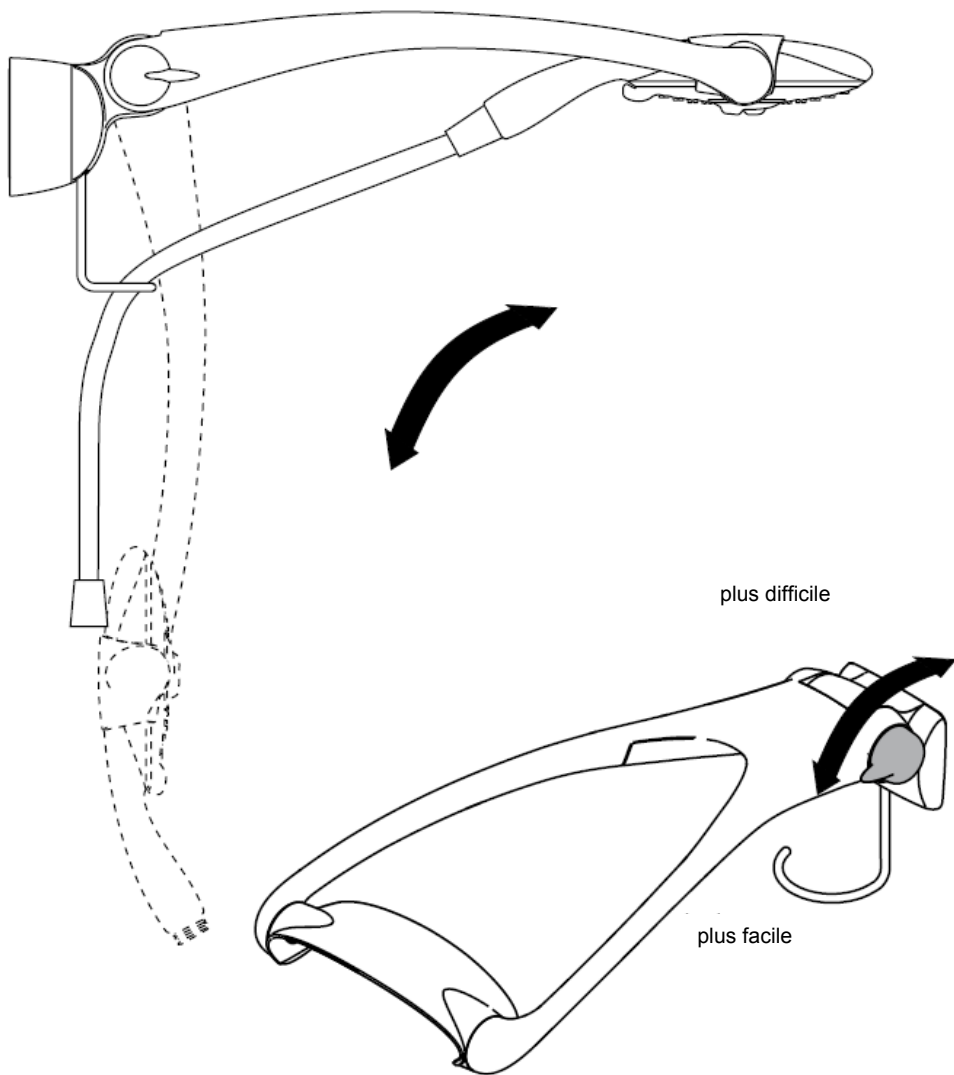

Con Rubit®, la funzione anticalcare manuale, i diffusori del getto possono essere liberati da calcare con un semplice strofinamento.

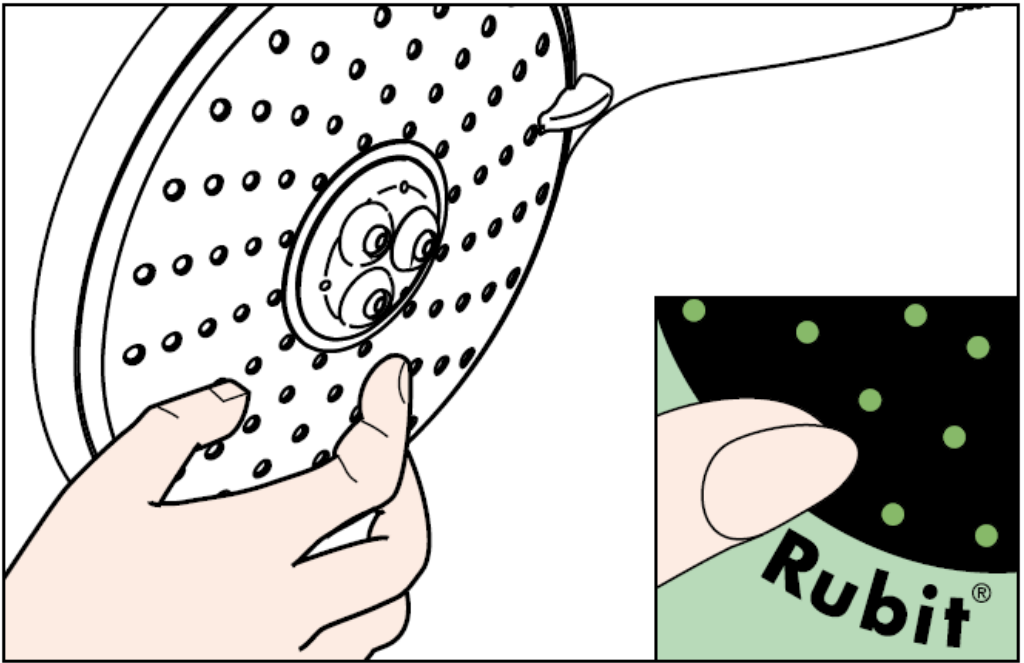

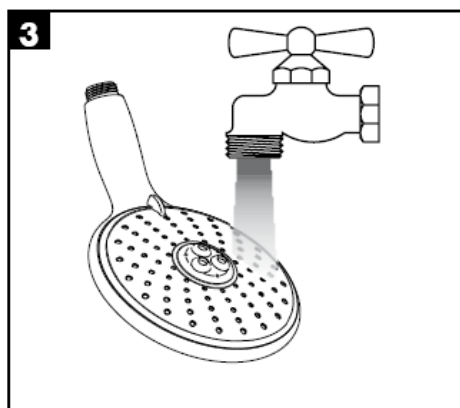
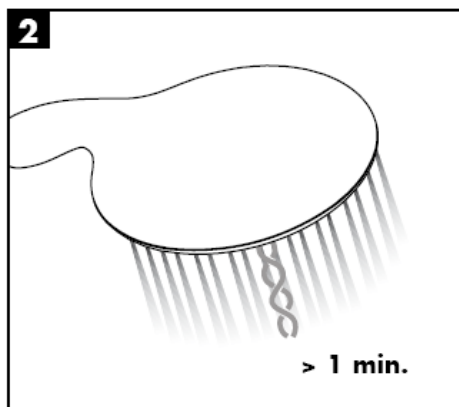
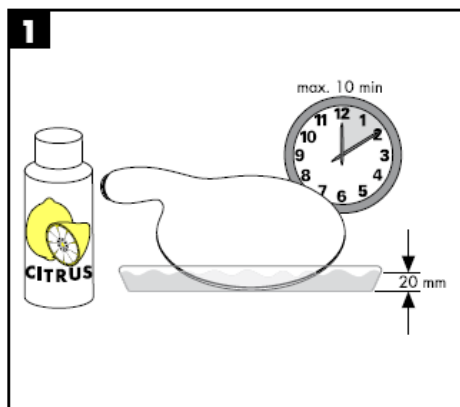

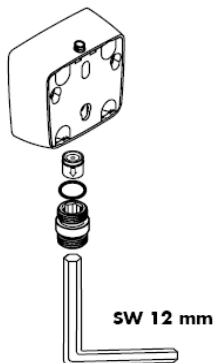

Attenzione!

La valvola di non ritorno deve essere controllata una volta all'anno.

hansgrohe

Hansgrohe · Postfach 1145 · D-77761 Schiltach · Telefon +49 (0) 78 36/51-1282 · Telefax +49 (0) 7836/511440
E-Mail: info@hansgrohe.com · Internet: www.hansgrohe.com

02/2008
9.06081.04
Italiano

Instrucciones de montaje

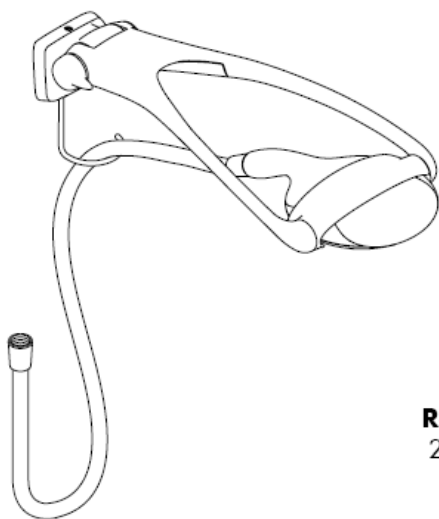

Raindance
28105000

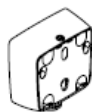

Raindance
28108000

Raindance Allrounder Set
28100000 / 28110000

hansgrohe

Raindance Allrounder Set

28100000 / 28110000

Classification acoustique et débit 28110000: ACS

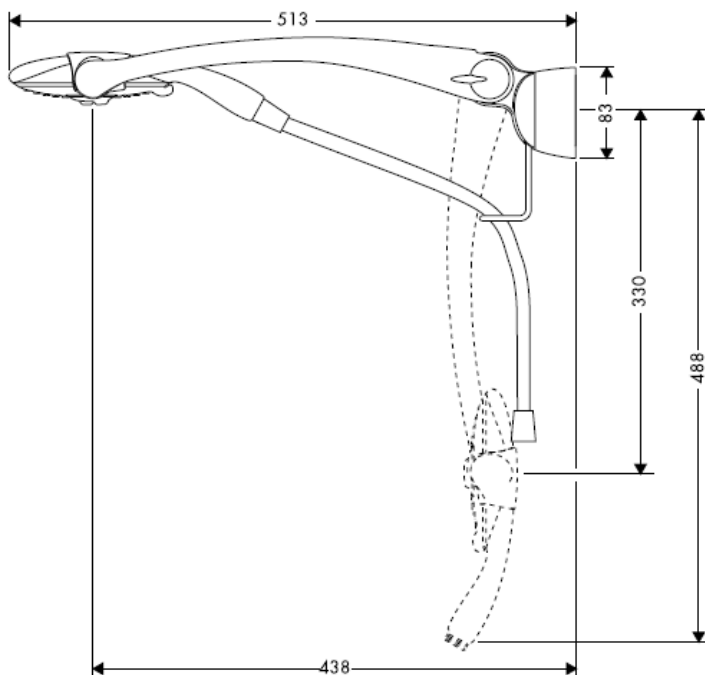

Raindance Eckmontage Set

28105000



Raindance UP-Adapter für Schlauchanschluß

28108000

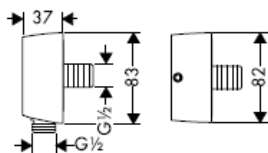

Raindance Allrounder Set

28100000 / 28110000

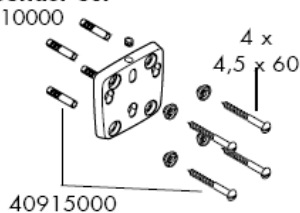

98562000

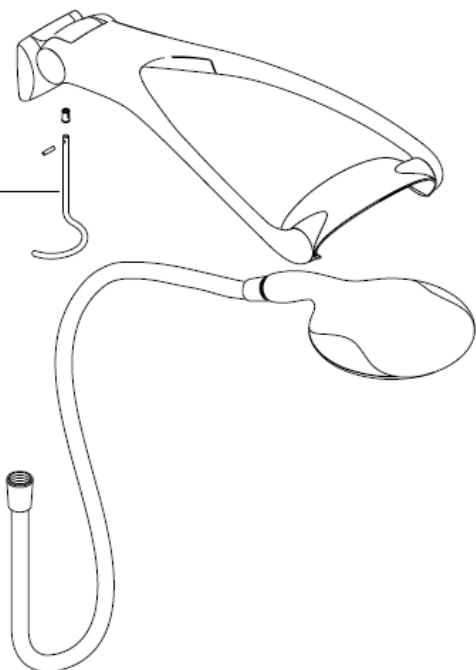

Raindance Eckmontage Set

28105000

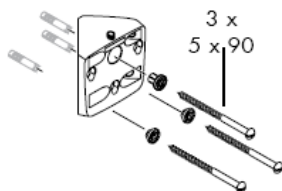

Raindance UP-Adapter für Schlauchanschluss

28108000

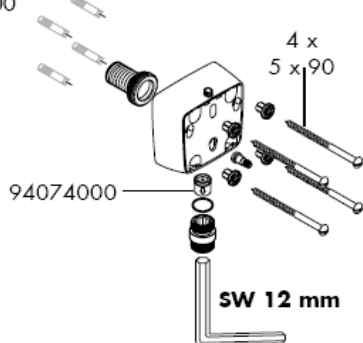

Montaje

La inserción del filtro (A) debe usarse para asegurar el caudal estandar y para proteger la ducha de la suciedad proveniente de las tuberías. Si se quiere un caudal mayor, se debe usar el paquete de filtro (B) en lugar de la inserción de filtro (A).

La suciedad puede producir defectos y/o puede dañar partes de la cabecera de la ducha. Por dichos defectos o fallos Hansgrohe no se hace responsable.

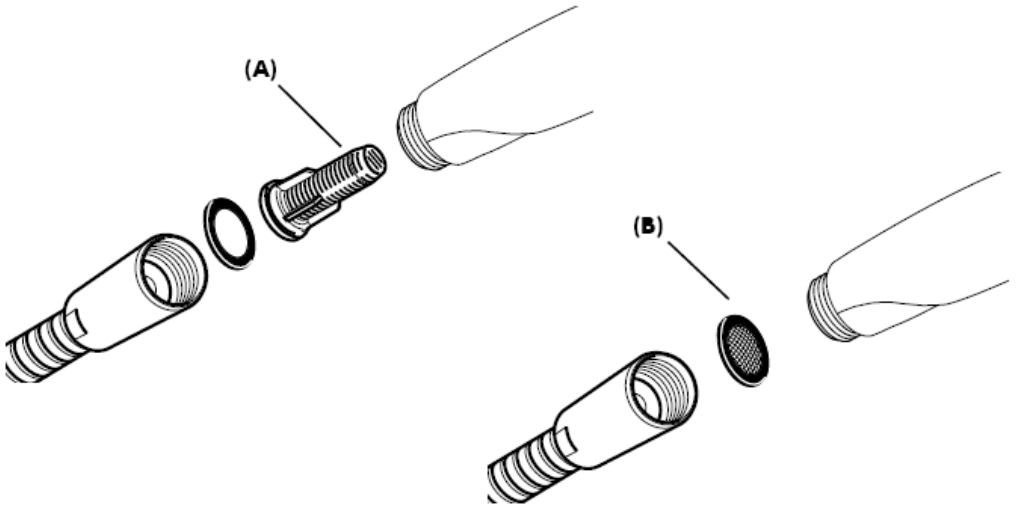

Con inserción de filtro (A)

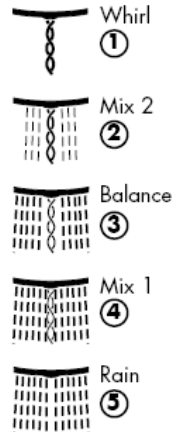
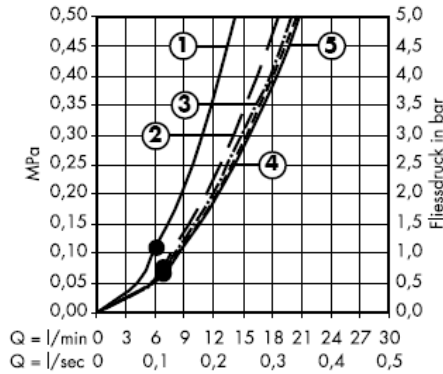

Con paquete de filtro (B)

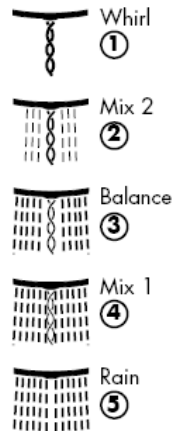
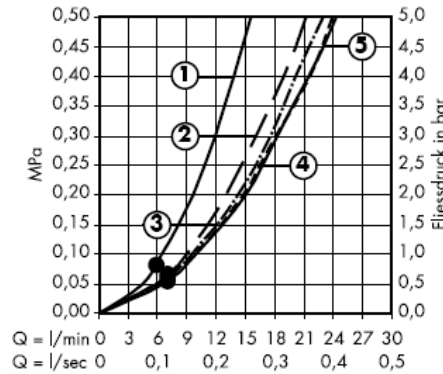

Mínimo • para el correcto funcionamiento.

Con inserción de filtro (A)

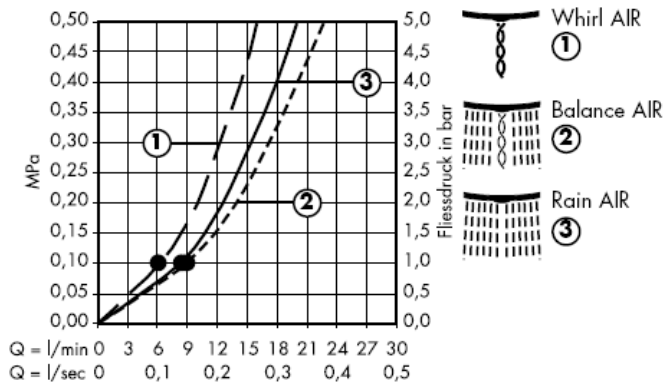

Con paquete de filtro (B)

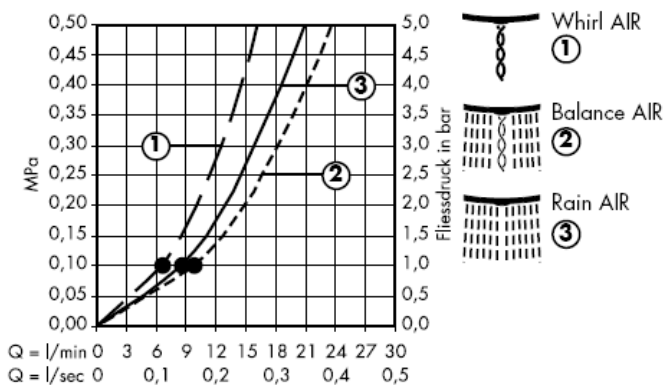

Mínimo • para el correcto funcionamiento.

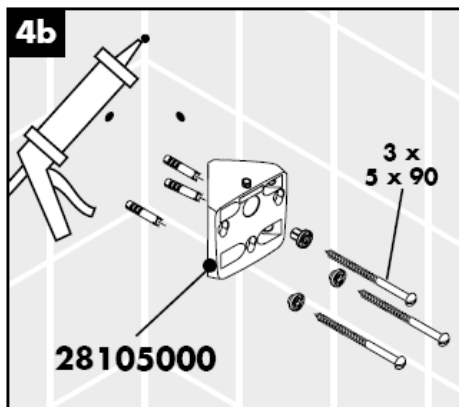
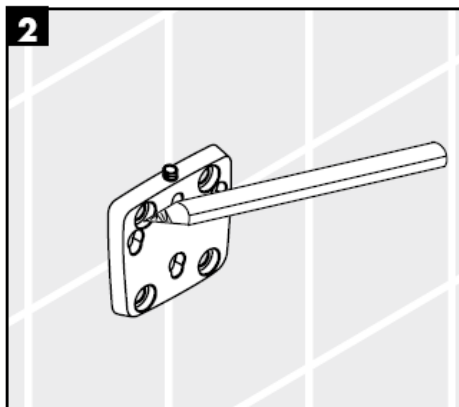

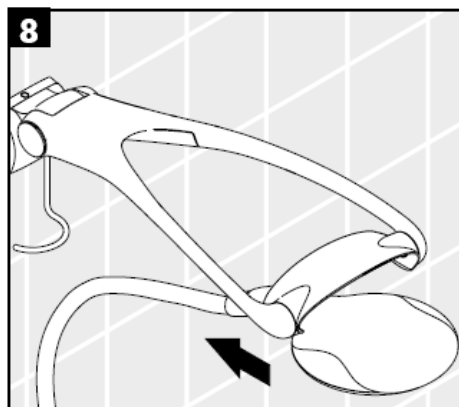
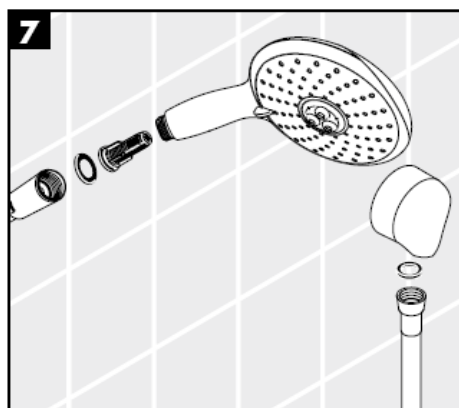
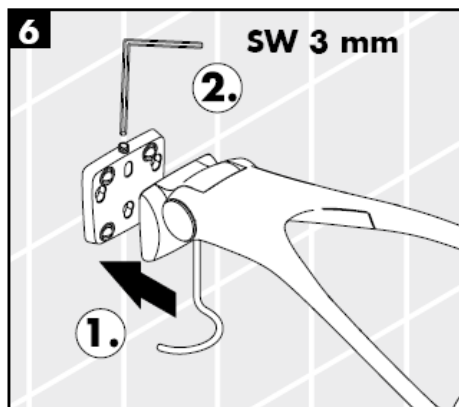
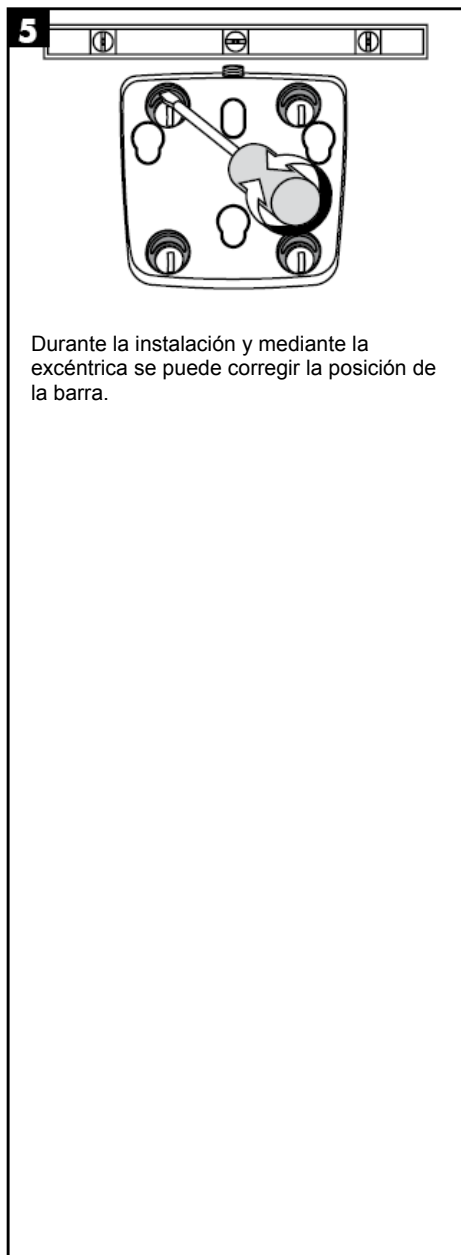

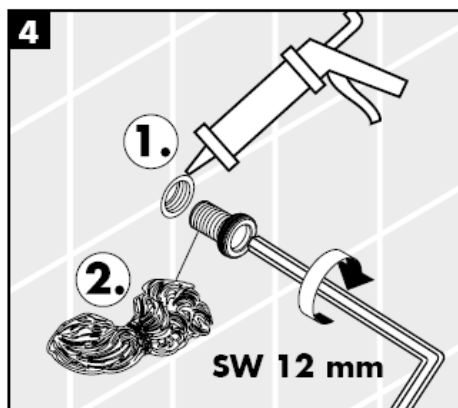
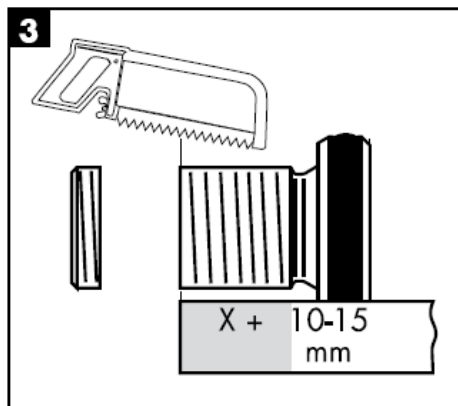
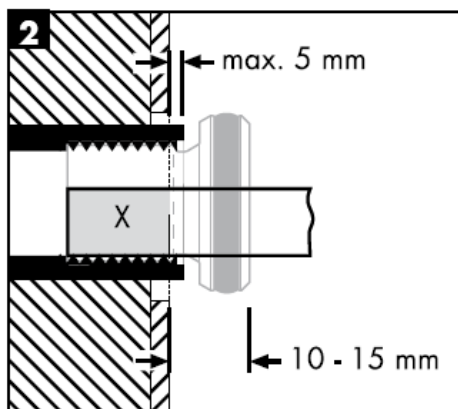
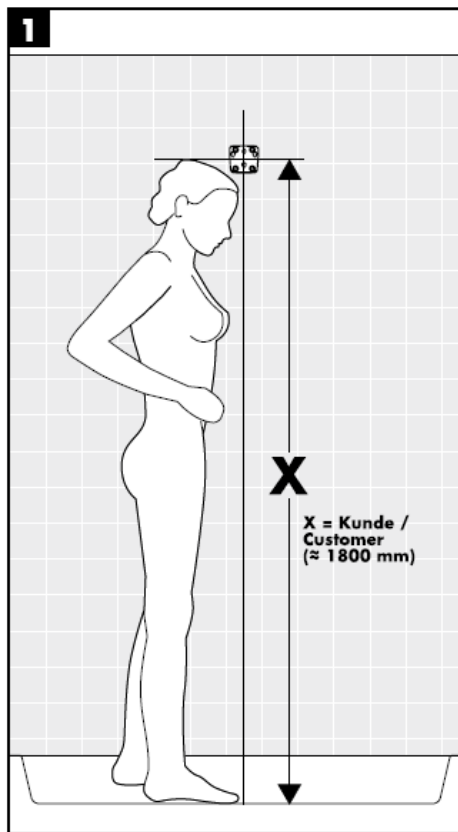

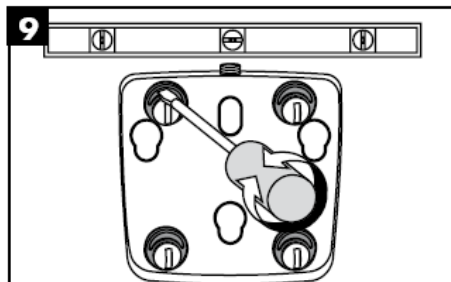
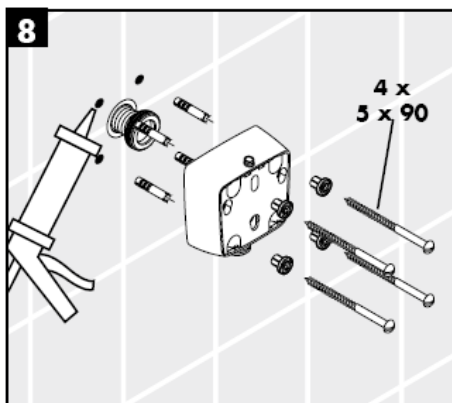
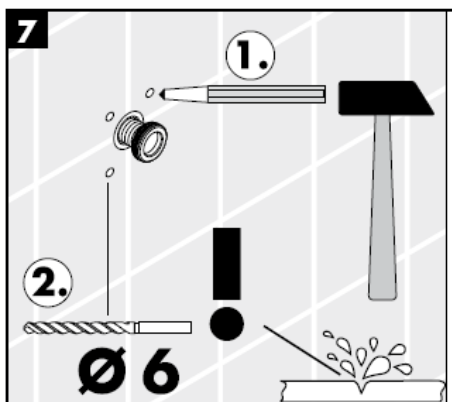
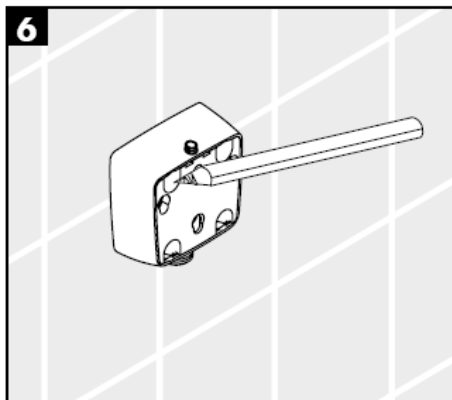

Durante la instalación y mediante la excéntrica se puede corregir la posición de la barra.





El Set Allrounder es un sistema de ducha multifuncional. Permite disfrutar de una ducha lateral, al igual que una ducha fija y teleducha por separado.

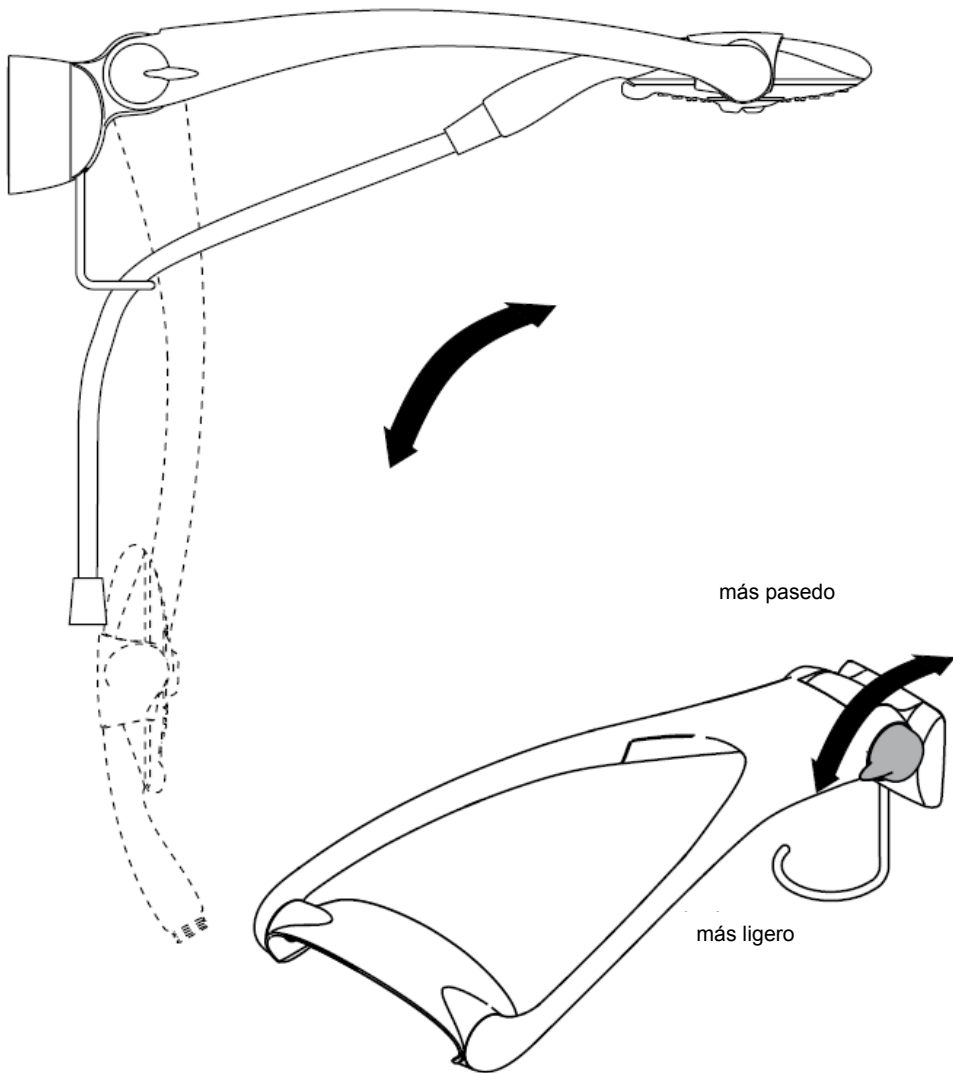

Rubit®, la función de limpieza manual, permite quitar la cal simplemente frotando los ejectores.

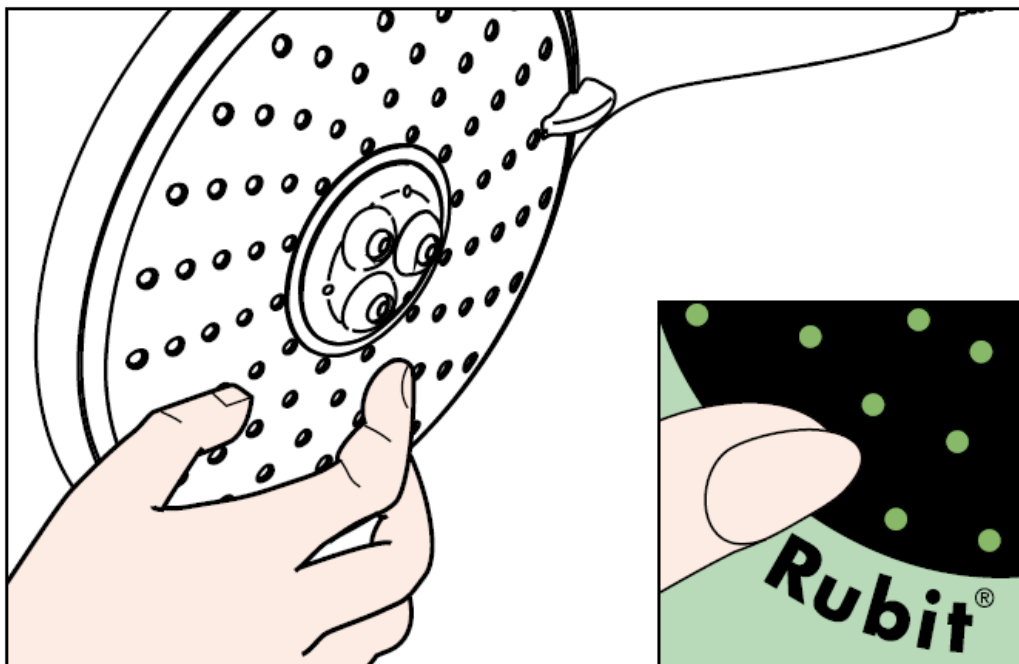

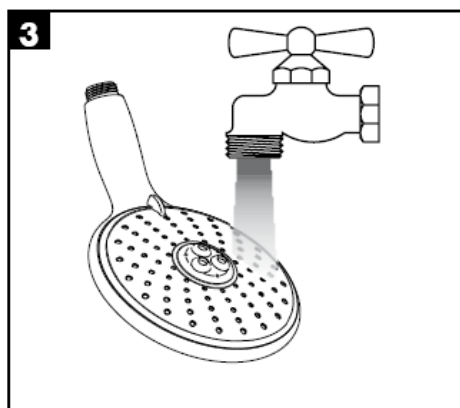
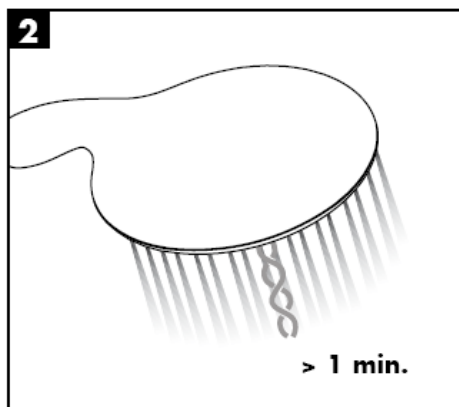
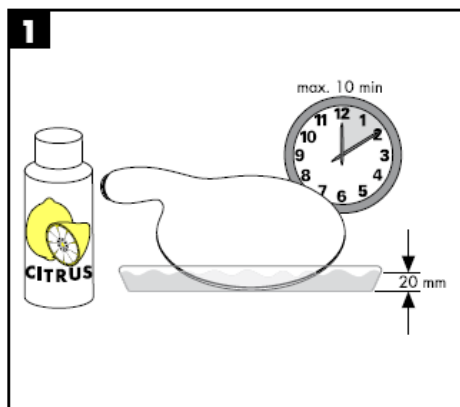

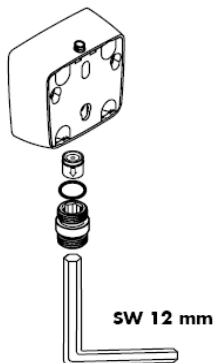

¡Atención!

Las válvulas anti-retorno se han de revisar una vez al año.

hansgrohe

Hansgrohe · Postfach 1145 · D-77761 Schiltach · Telefon +49 (0) 78 36/51-1282 · Telefax +49 (0) 7836/511440
E-Mail: info@hansgrohe.com · Internet: www.hansgrohe.com

02/2008
9.06081.04
Español

Handleiding

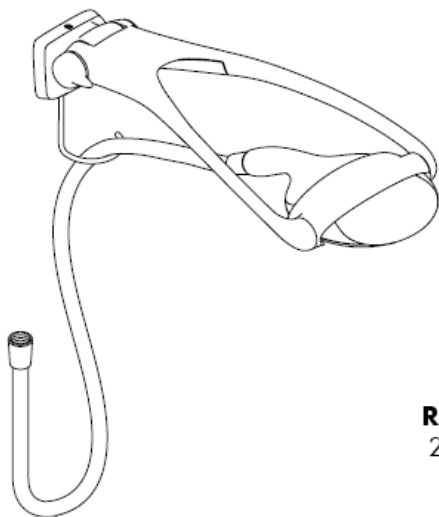

Raindance
28105000

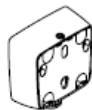

Raindance
28108000

Raindance Allrounder Set
28100000 / 28110000

hangrohe

Raindance Allrounder Set

28100000 / 28110000

Classification acoustique et débit 28110000: ACS

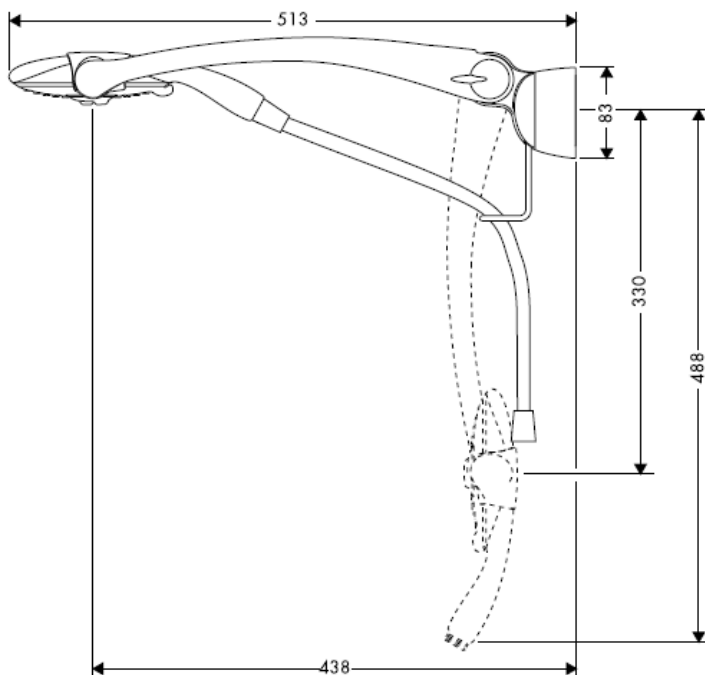

Raindance Eckmontage Set

28105000



Raindance UP-Adapter für Schlauchanschluß

28108000



Raindance Allrounder Set

28100000 / 28110000

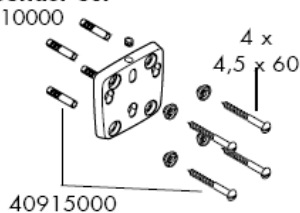

98562000

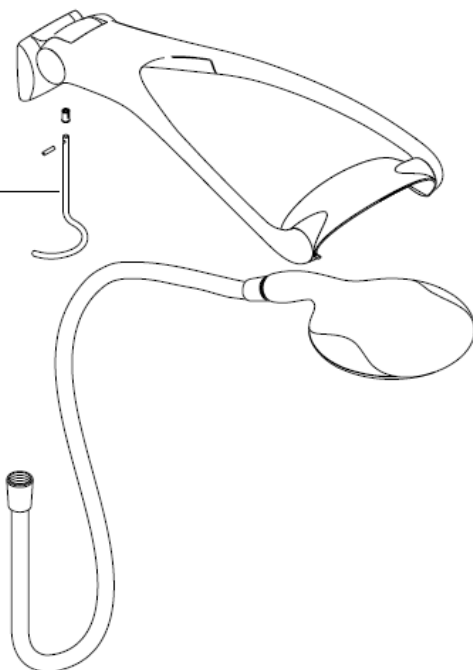

Raindance Eckmontage Set

28105000

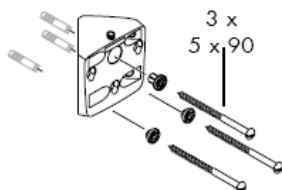

Raindance UP-Adapter für Schlauchanschluss

28108000

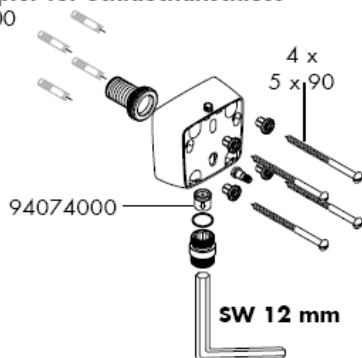

Montage

De bijgeleverde filter (A) moet ingebouwd worden om de norm doorstroom van de handdouche te garanderen en vuil uit de leidingen tegen te houden. Als er een grotere waterdoorlaat gewenst wordt i.p.v. het filter de dichting geplaatst worden. Vuil uit de leidingen kan schade aan de handdouche veroorzaken. Op deze schade geeft Hansgrohe geen garantie.

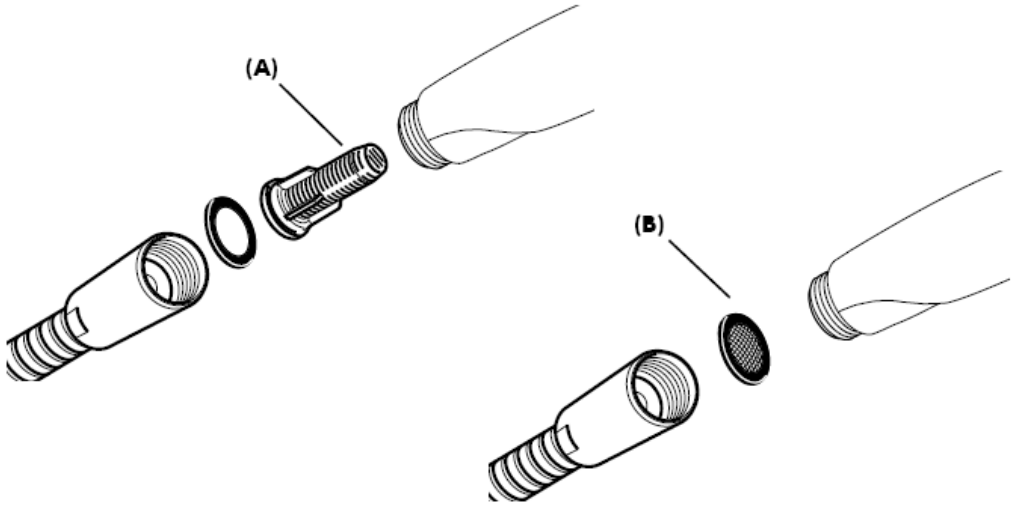

Met filter (A)

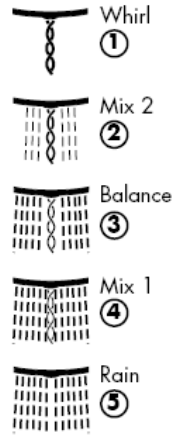
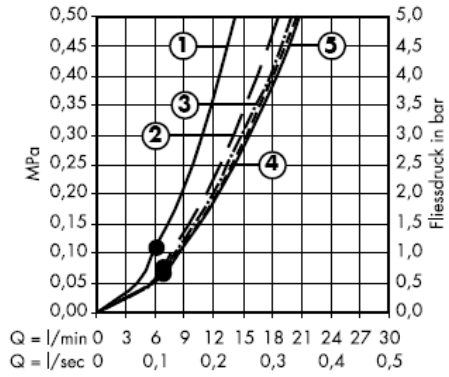

Met dichting (B)

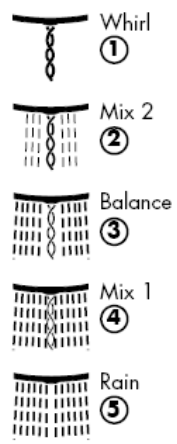
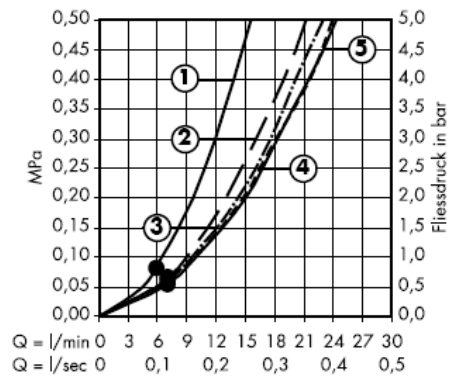

Vanaf • is het functioneren gegarandeerd.

Met filter (A)

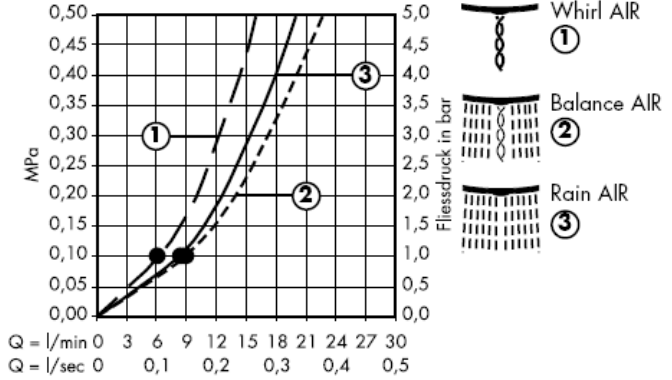

Met dichting (B)

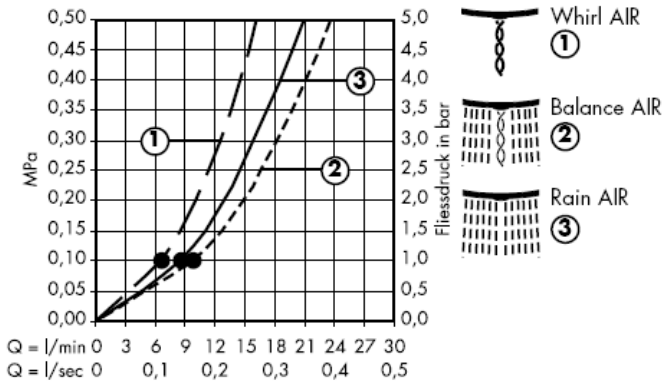

Vanaf • is het functioneren gegarandeerd.

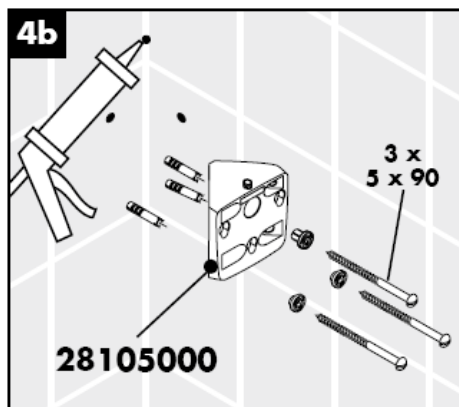
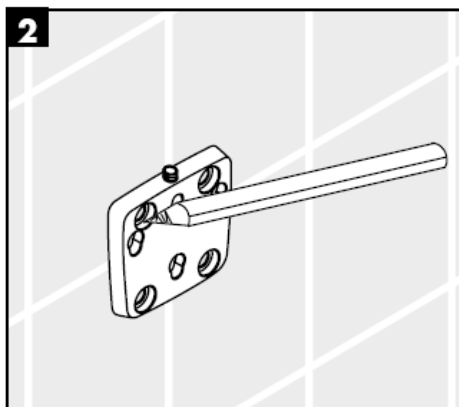
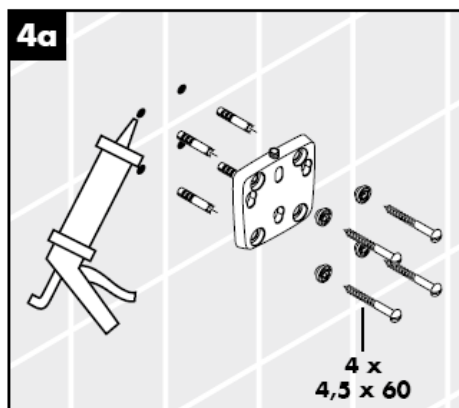
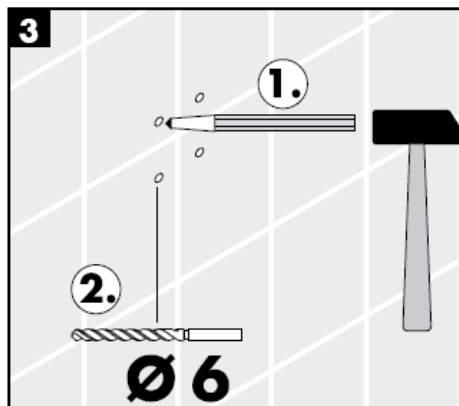

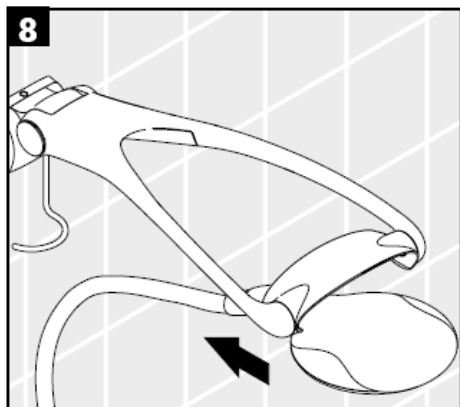
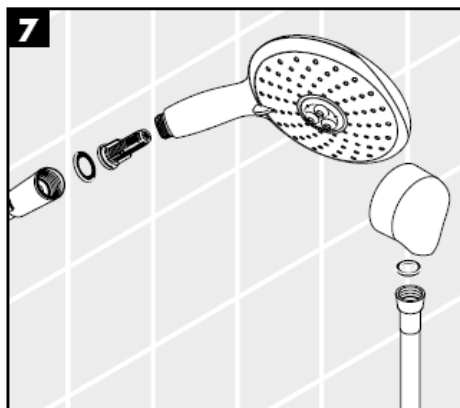
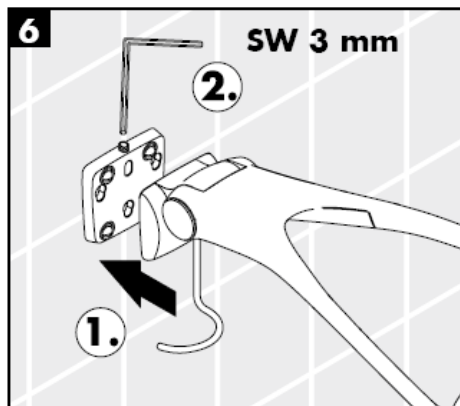
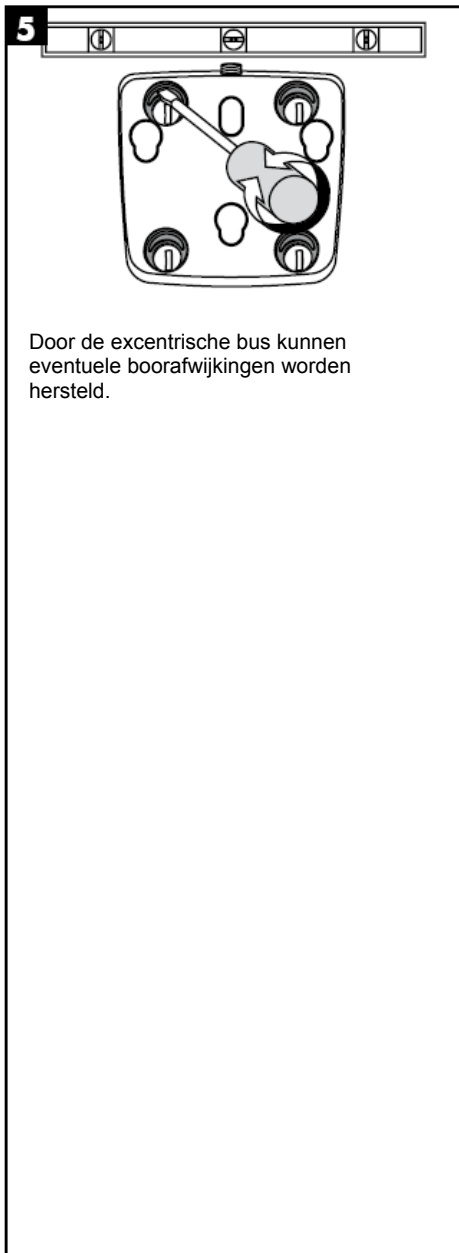

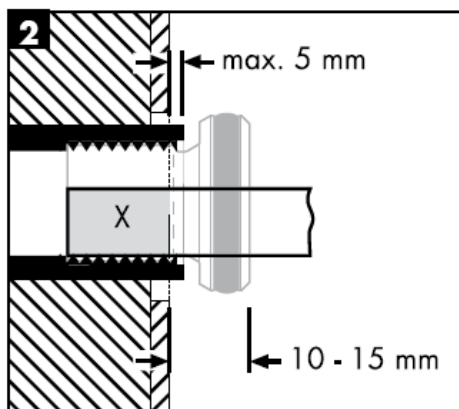
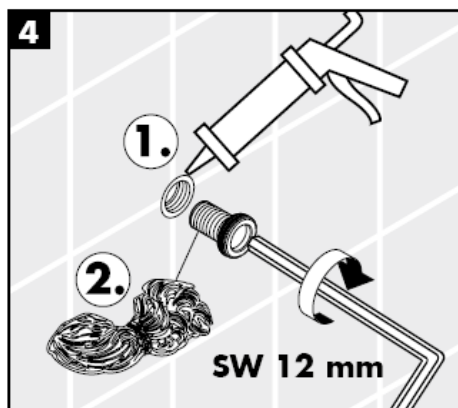
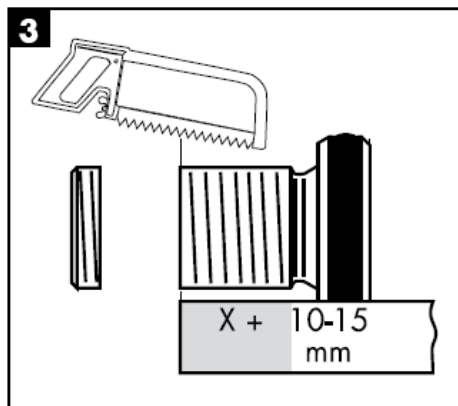
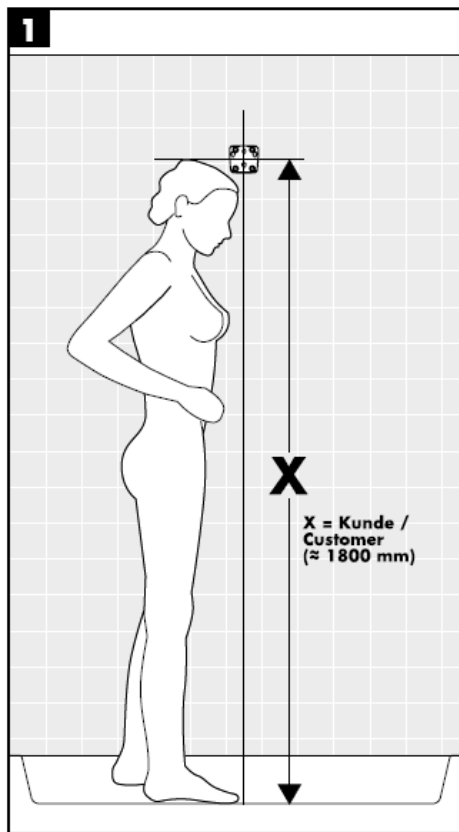

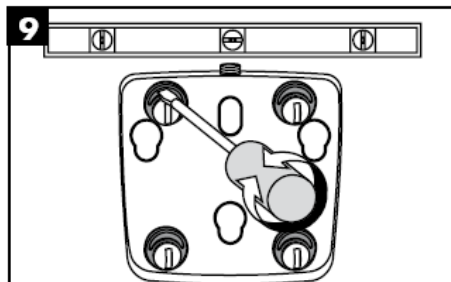
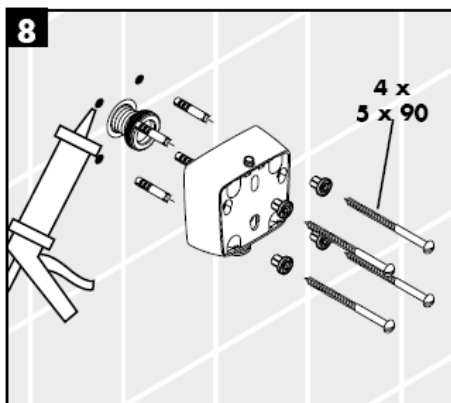
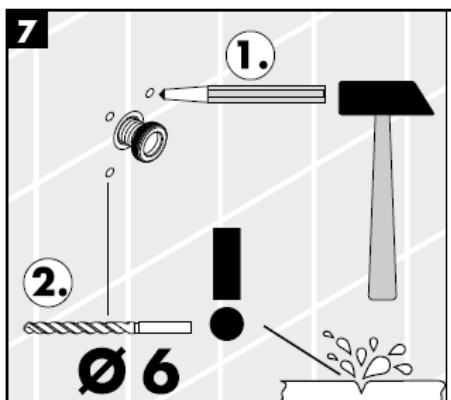
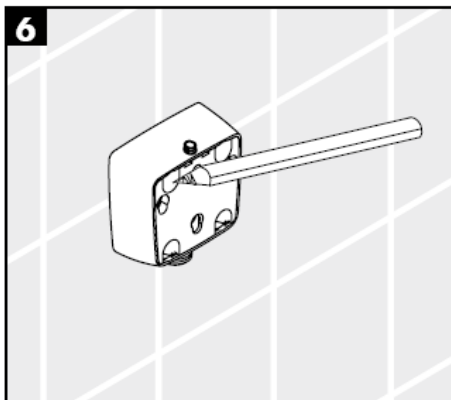

Door de excentrische bus kunnen eventuele boorafwijkingen worden hersteld.





De Allrounder-set is een multifunctioneel douchesysteem. Afhankelijk van het draaien van de Houder kan de Raindance als hand-, hoofd- of zijdouche worden gebruikt.

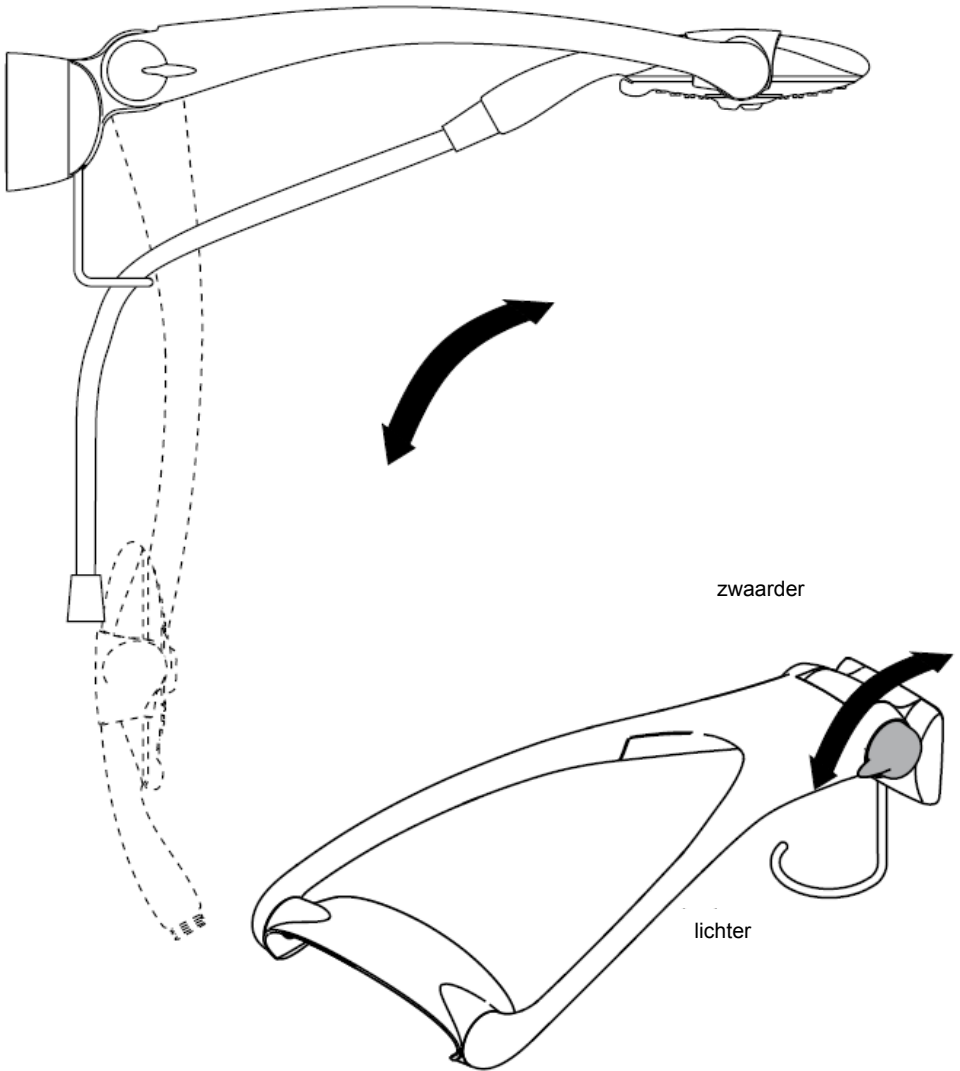

Reinigen

Met Rubit®, de handmatige reinigingsfunctie, kunnen de straalopeningen door het met de hand wegwrijven van kalk, gereinigd worden.

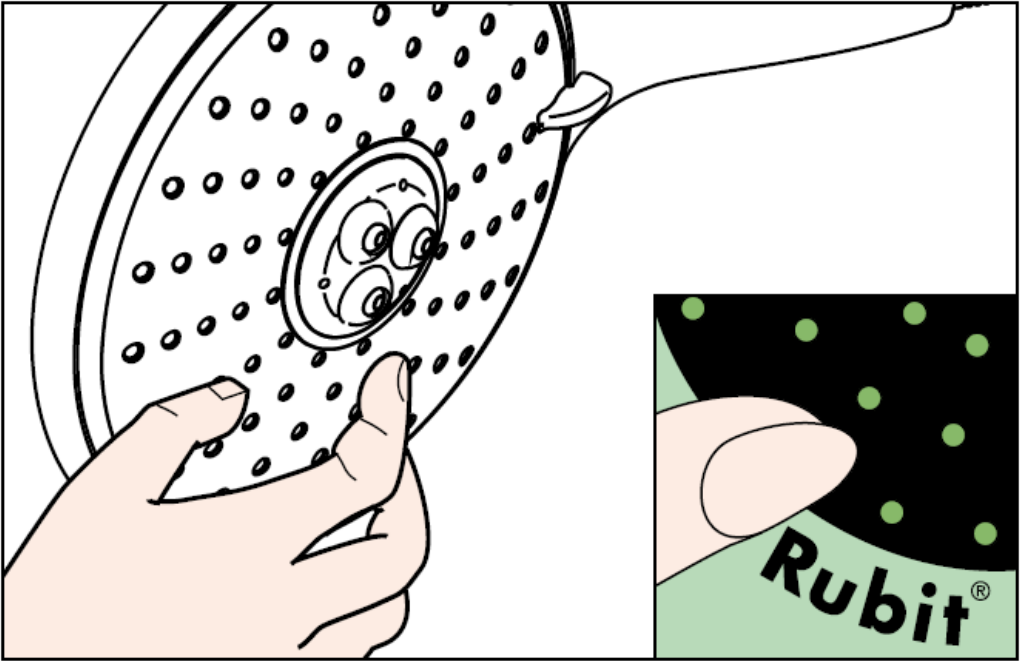

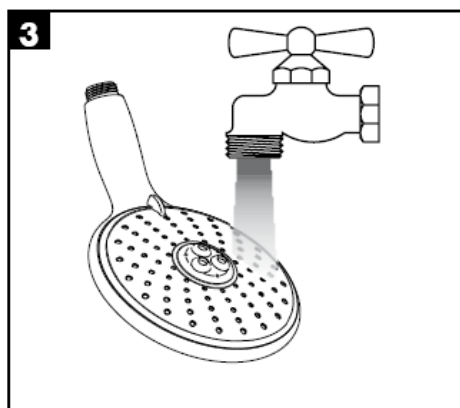
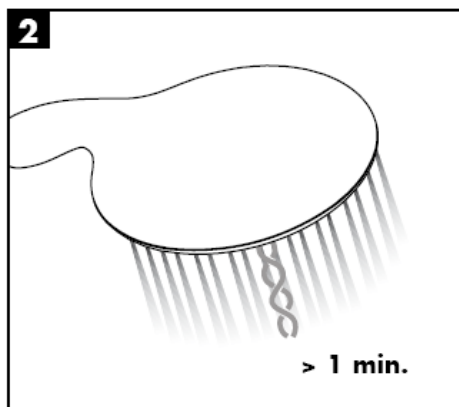
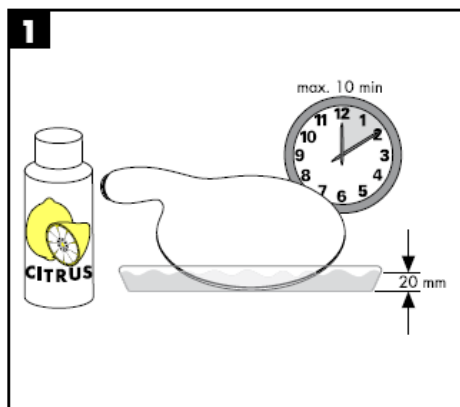

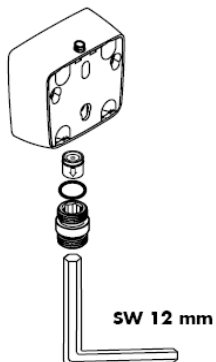

Attentie!

Het functioneren van de terugslagklep-pen moet jaarlijks worden getest.

hansgrohe

Hansgrohe · Postfach 1145 · D-77761 Schiltach · Telefon +49 (0) 78 36/51-1282 · Telefax +49 (0) 7836/511440
E-Mail: info@hansgrohe.com · Internet: www.hansgrohe.com

02/2008
9.06081.04
Nederlands

Monteringsvejledning

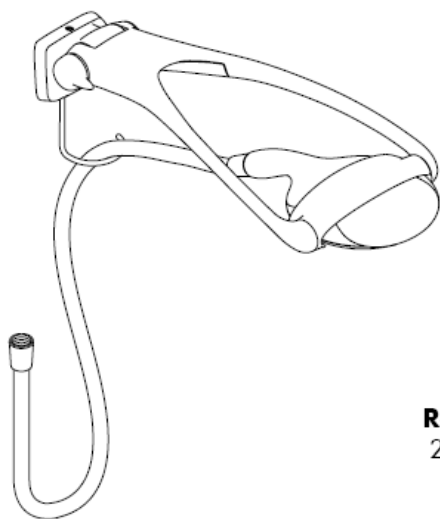

Raindance
28105000

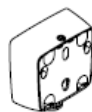

Raindance
28108000

Raindance Allrounder Set
28100000 / 28110000

hansgrohe

Raindance Allrounder Set

28100000 / 28110000

Classification acoustique et débit 28110000: ACS

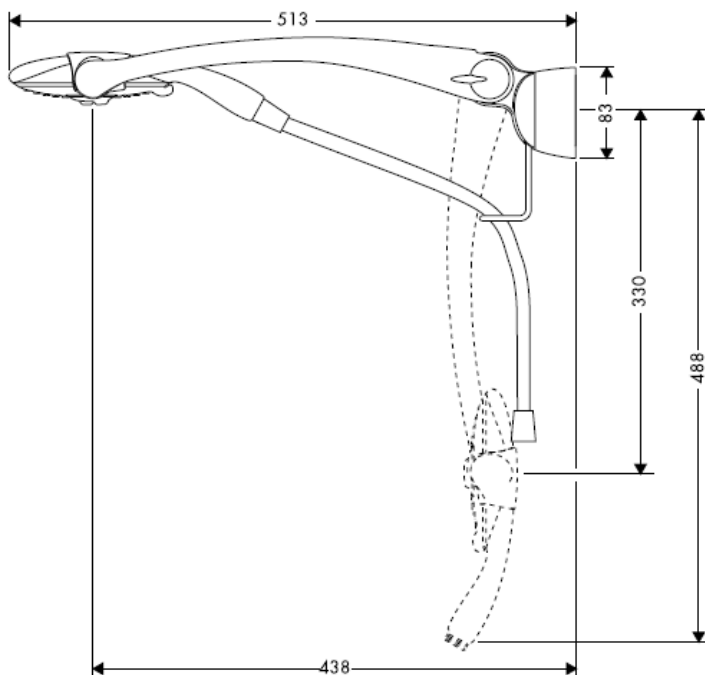

Raindance Eckmontage Set

28105000



Raindance UP-Adapter für Schlauchanschluß

28108000

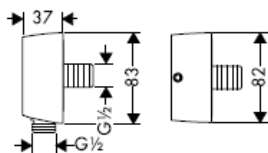

Raindance Allrounder Set

28100000 / 28110000

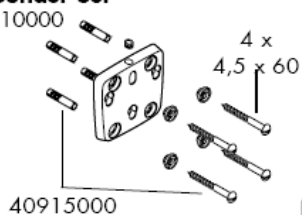

98562000

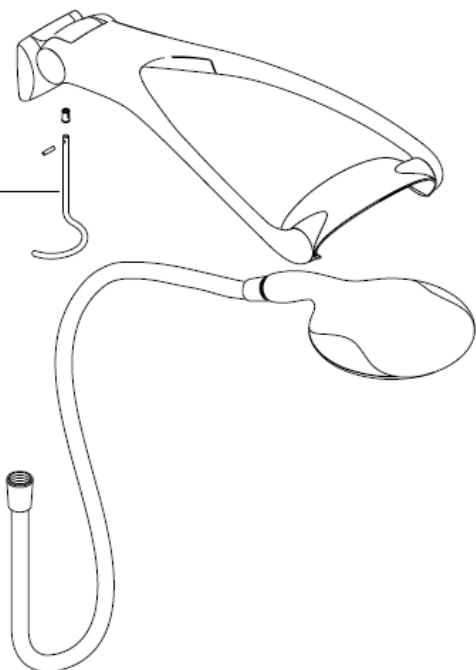

Raindance Eckmontage Set

28105000

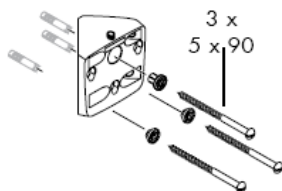

Raindance UP-Adapter für Schlauchanschluss

28108000

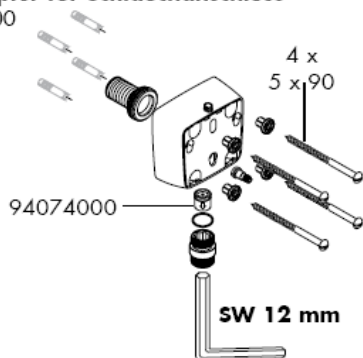

Montering

Den vedlagte filterindsats (A) skal monteres for at sikre en normal vandgennemstrømning og for at forhindre at der kommer smuds i håndbruseren fra rørsystemet. Ønskes en større vandgennemstrømning skal filterindsatsen (A) erstattes med en smudsfangsi (B).

Snaps der er kommet ind i håndbruseren kan skade funktionsdelene i håndbruseren, og Hansgrohes garanti gælder ikke for skader der er opstået på denne måde.

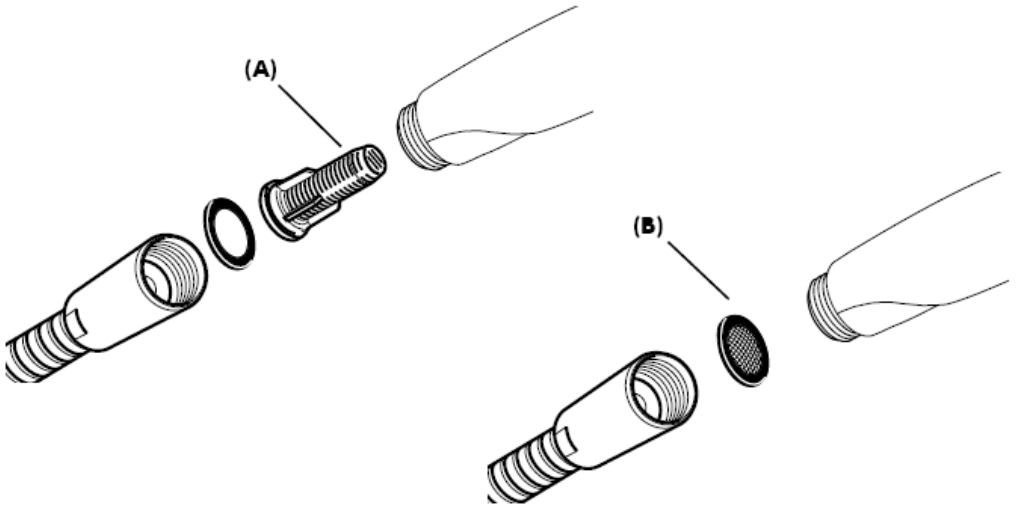

Med filterindsats (A)

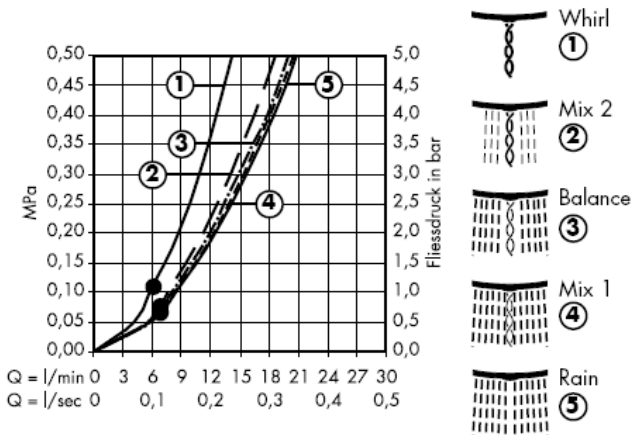

Med smudsfangsi (B)

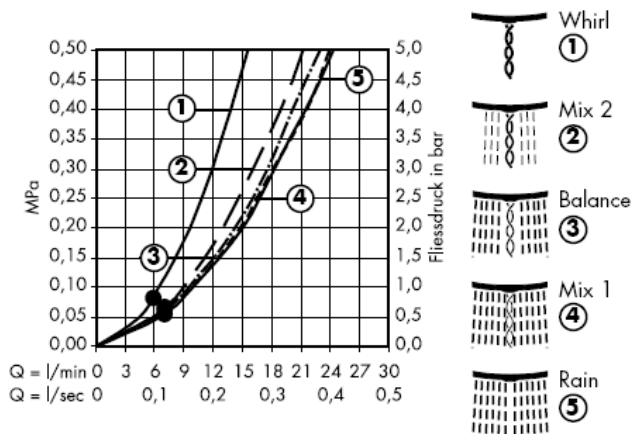

Fra • er funktionen anvendelig.

Med filterindsats (A)

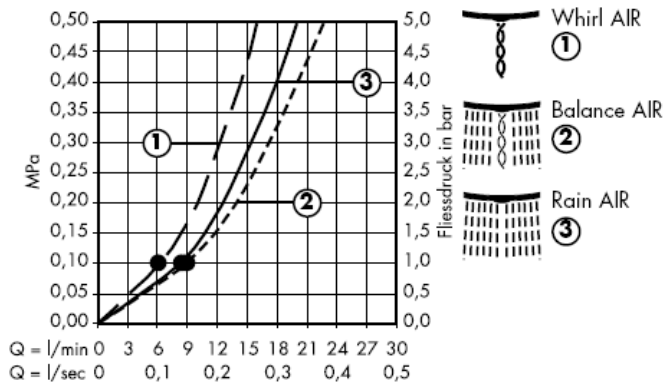

Med smudsfangsi (B)

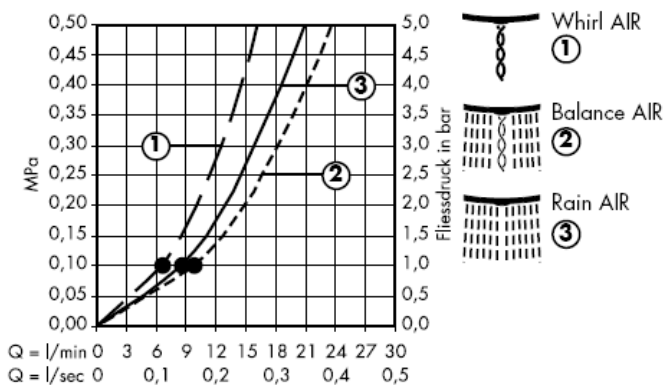

Fra • er funktionen anvendelig.

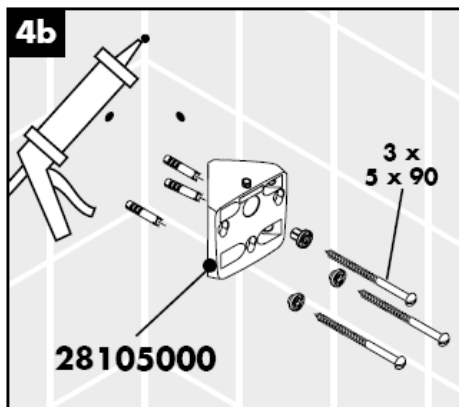
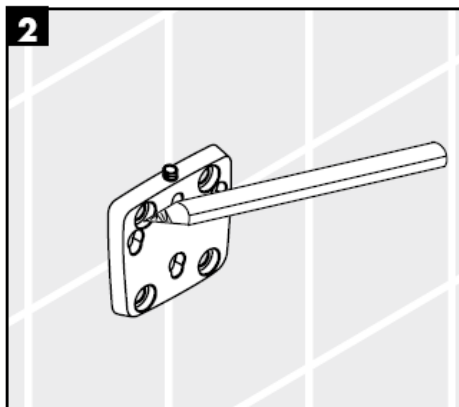
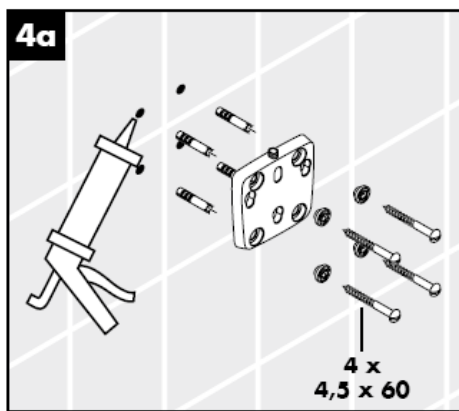
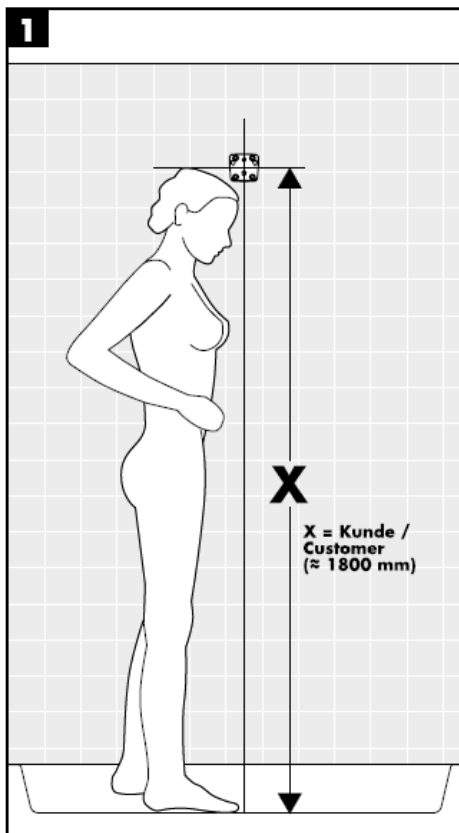

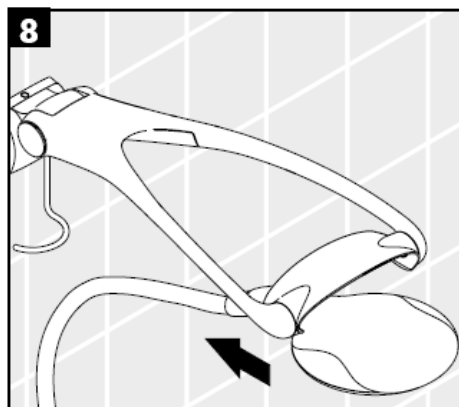
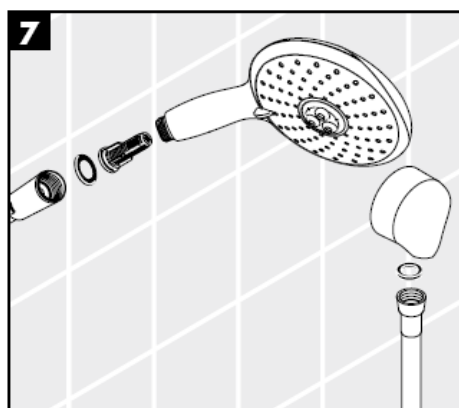
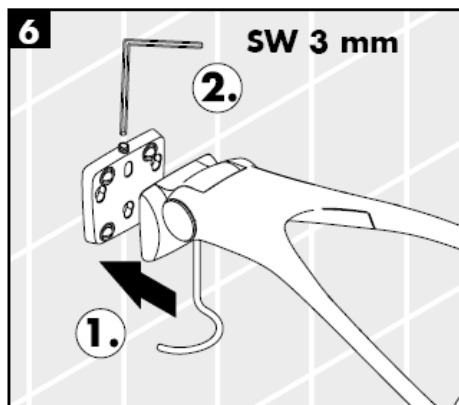

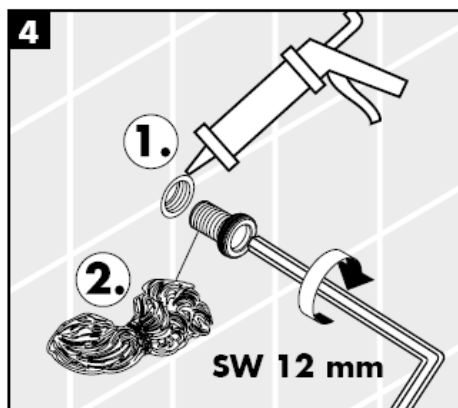
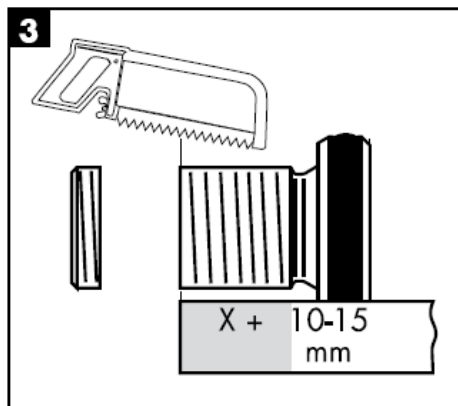
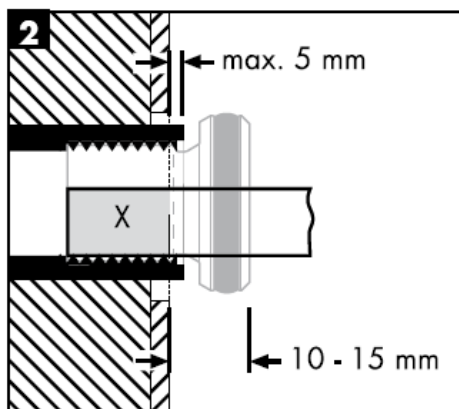
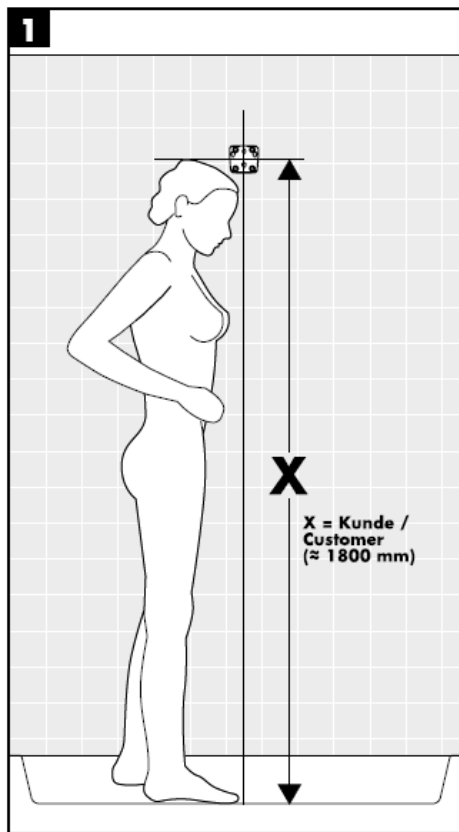

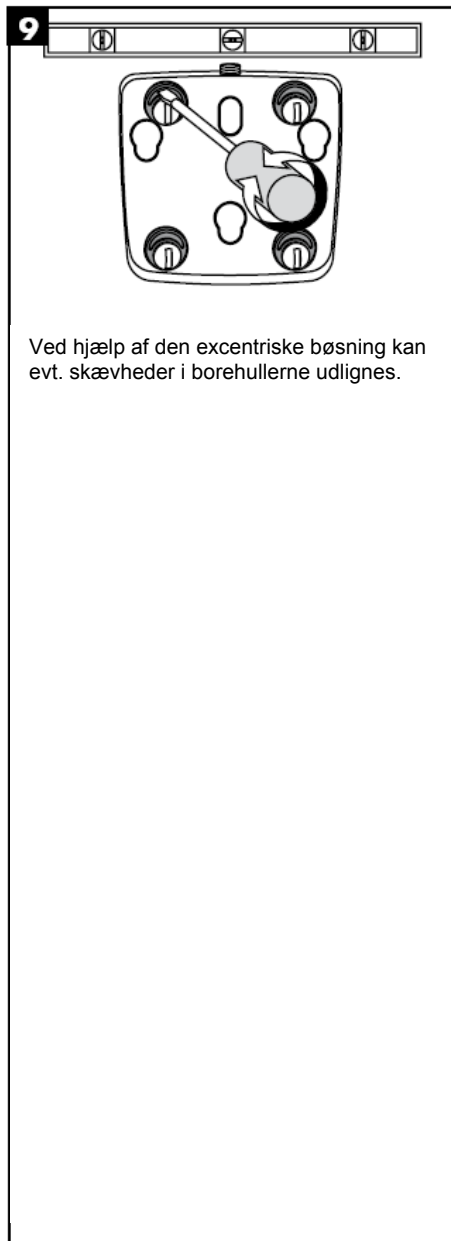
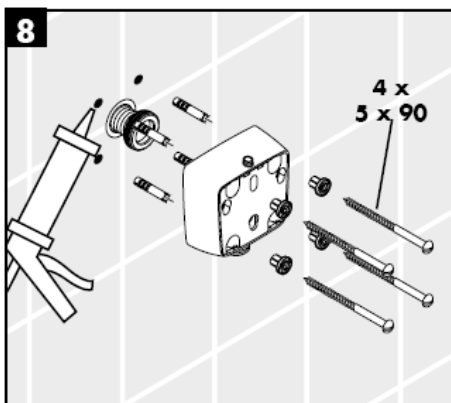
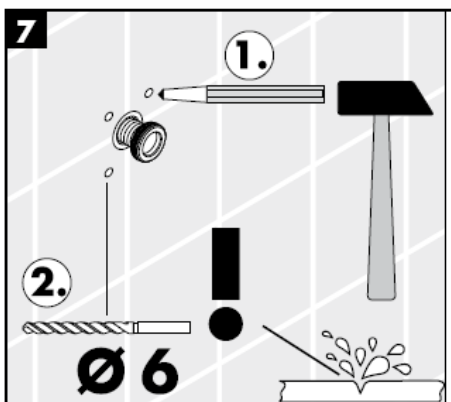
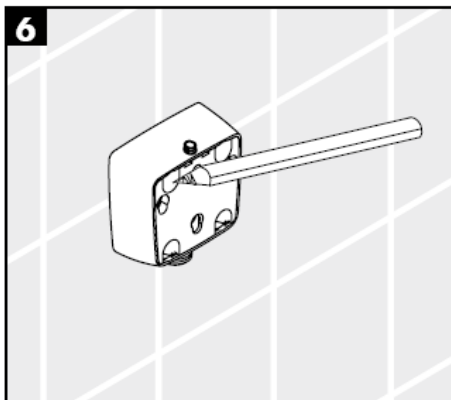





Allrounder sættet er et multifunktions brusersystem. Alt efter bøjleindstilling kan bruseren anvendes som hovedbruser, sidebruser eller håndbruser.

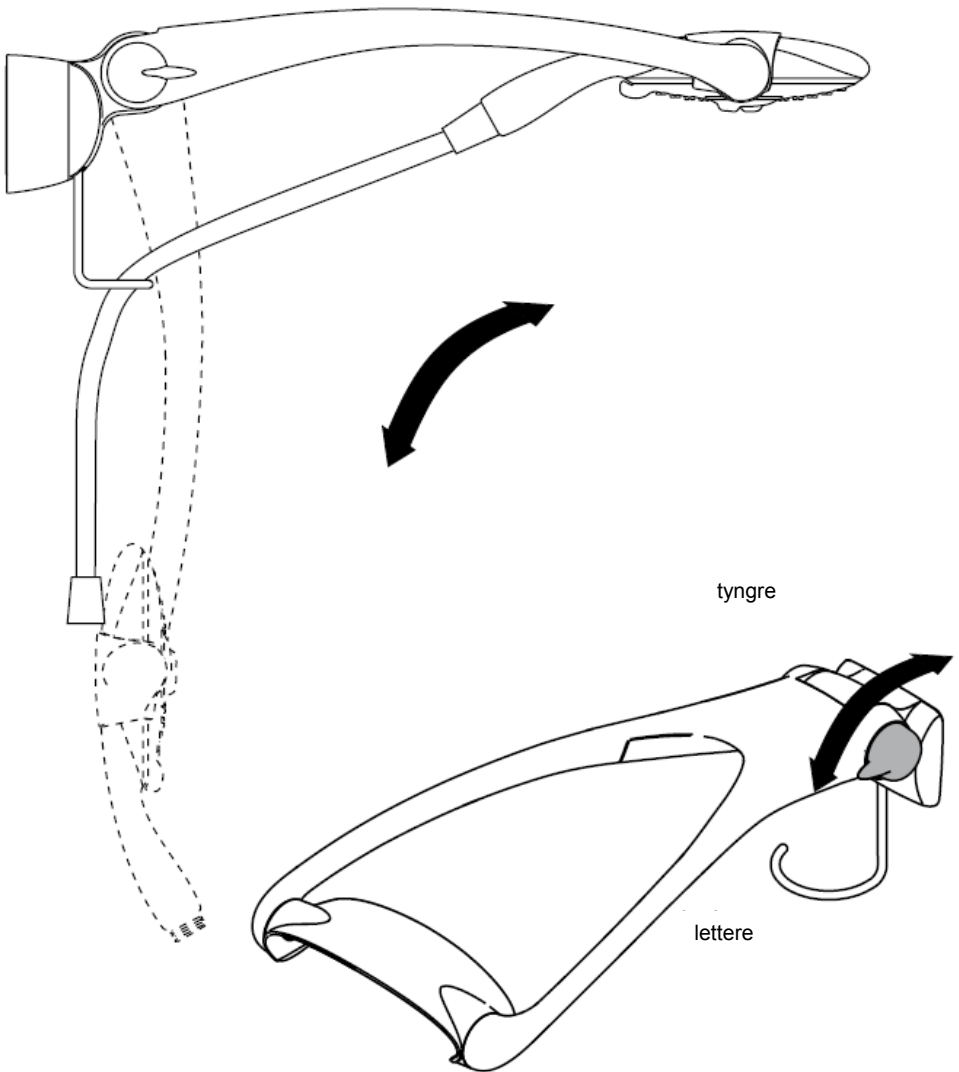

Rengøring

Med Rubit®, den manuelle rengøringsfunktion kan strålekanalerne let renses for kalk - der skal blot gnubbes!

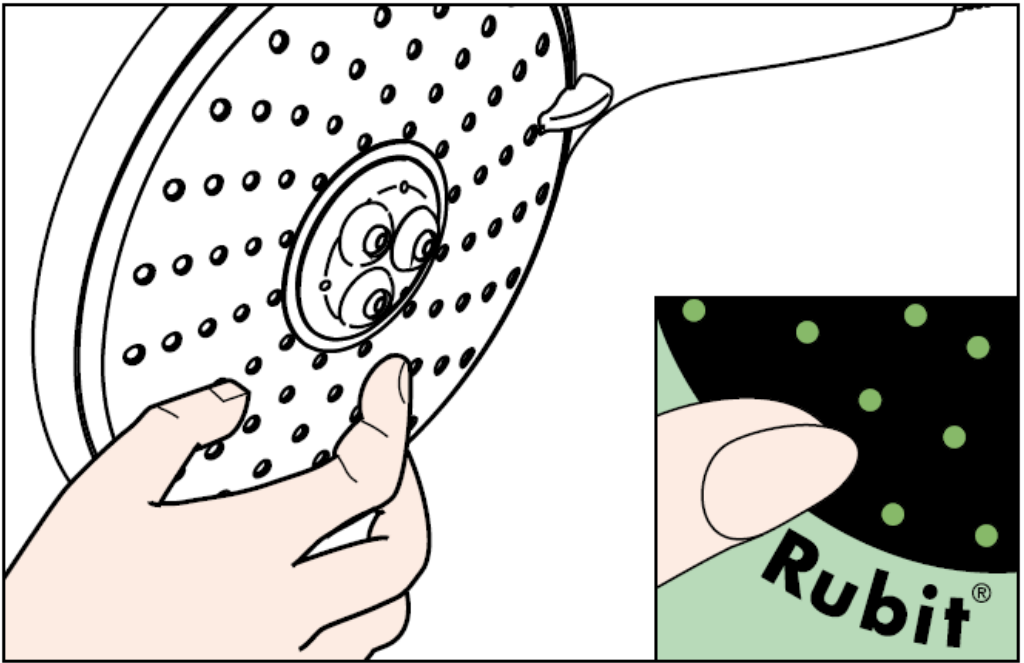

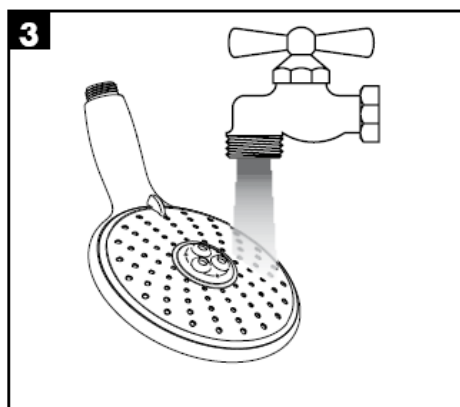
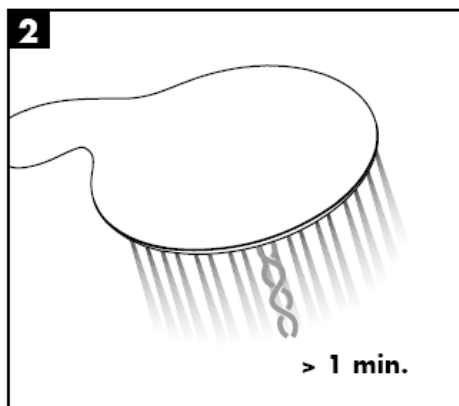
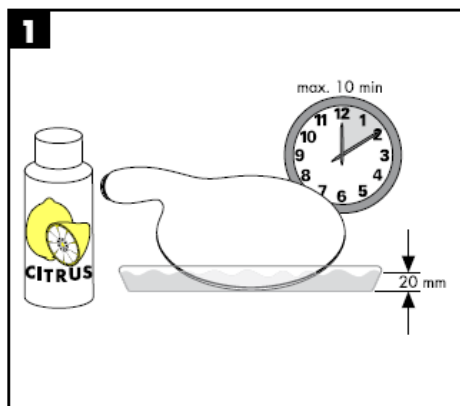

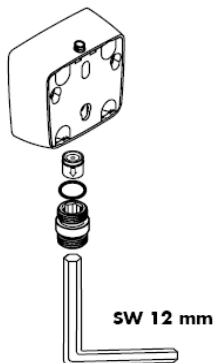

Advarsel!

Kontraventilen skal afprøves en gang om året.

hansgrohe

Hansgrohe · Postfach 1145 · D-77761 Schiltach · Telefon +49 (0) 78 36/51-1282 · Telefax +49 (0) 7836/511440
E-Mail: info@hansgrohe.com · Internet: www.hansgrohe.com

02/2008
9.06081.04
Dansk

Manual de Instalación

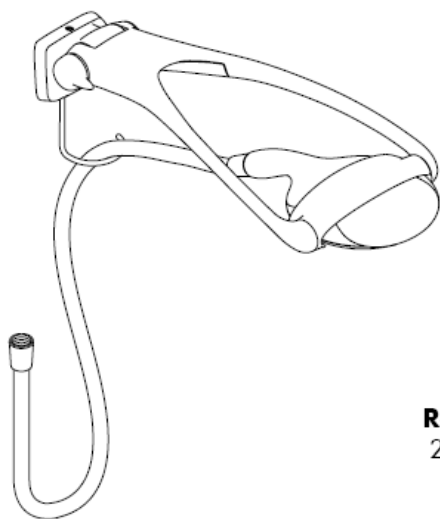

Raindance
28105000

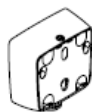

Raindance
28108000

Raindance Allrounder Set
28100000 / 28110000

hansgrohe

Raindance Allrounder Set

28100000 / 28110000

Classification acoustique et débit 28110000: ACS

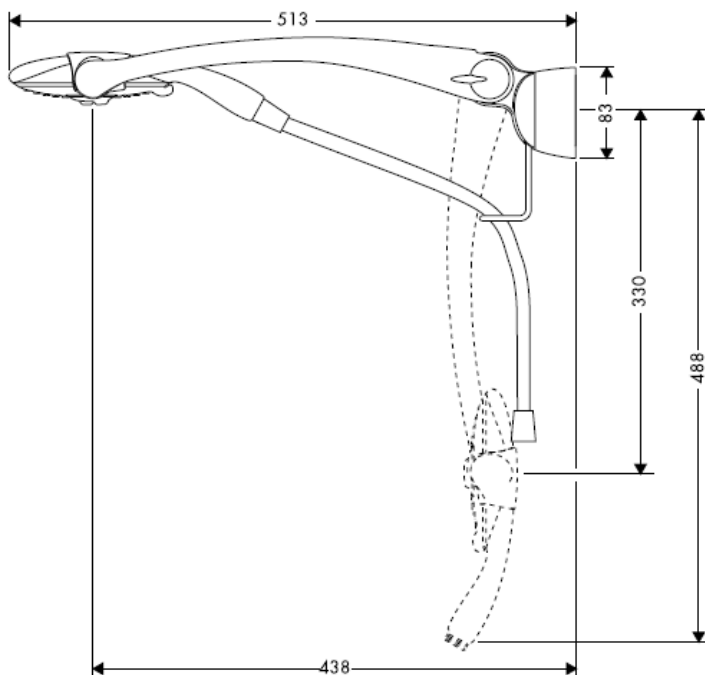

Raindance Eckmontage Set

28105000



Raindance UP-Adapter für Schlauchanschluß

28108000



Raindance Allrounder Set

28100000 / 28110000

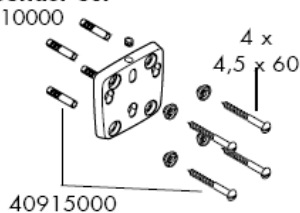

98562000

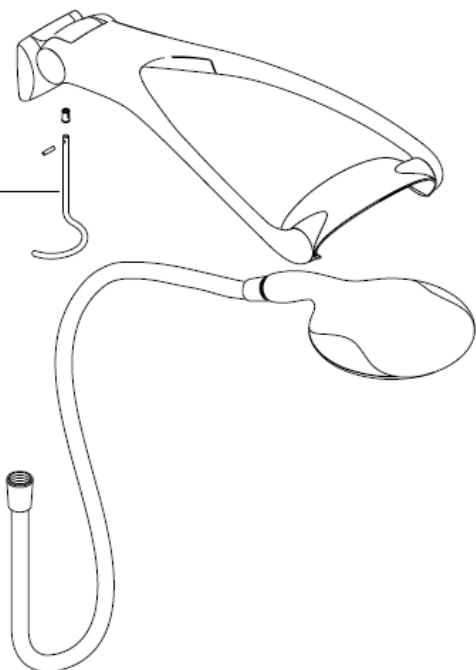

Raindance Eckmontage Set

28105000

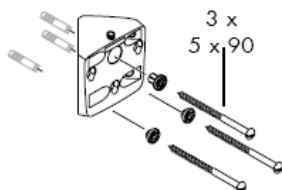

Raindance UP-Adapter für Schlauchanschluss

28108000

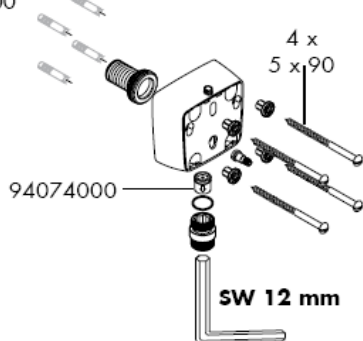

Montagem

O filtro de inserção (A) deve ser utilizado para assegurar um caudal standart e para proteger o chuveiro de mão de areias e resíduos provenientes da tubagem. Se quiser um caudal maior, deve usar o filtro de junção (B) em vez do filtro de inserção (A).

Resíduos e areias podem danificar componentes ou provocar o mau funcionamento do chuveiro; as avarias assim provocadas anulam a responsabilidade e garantia Hansgrohe.

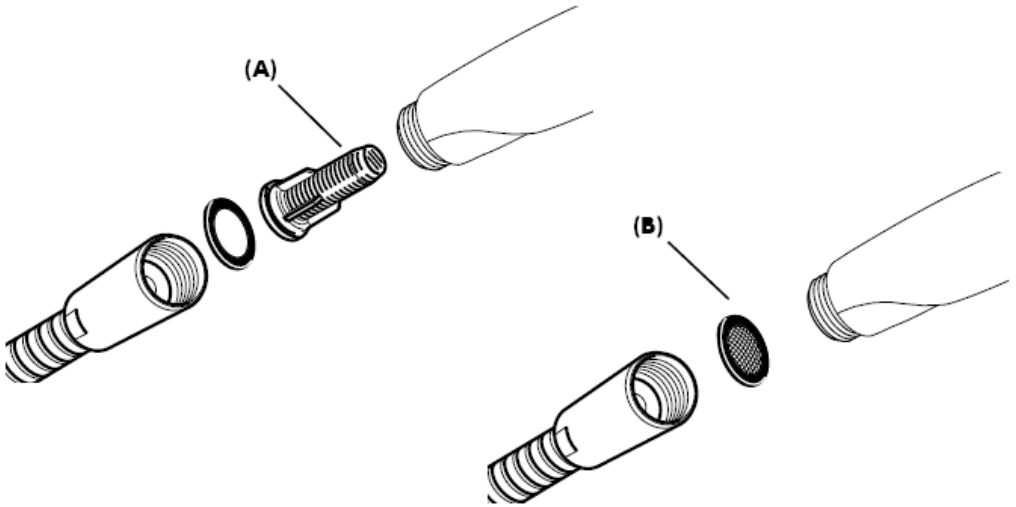

Com o filtro (A)

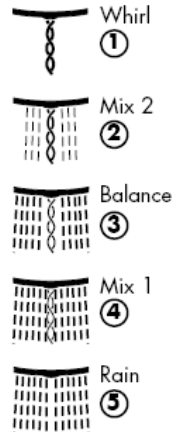
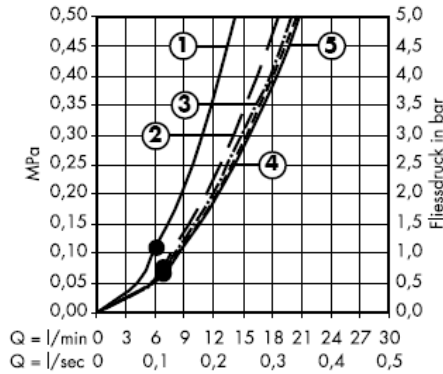

Com o filtro de junção (B)

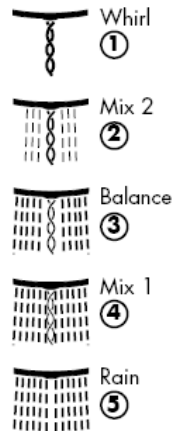
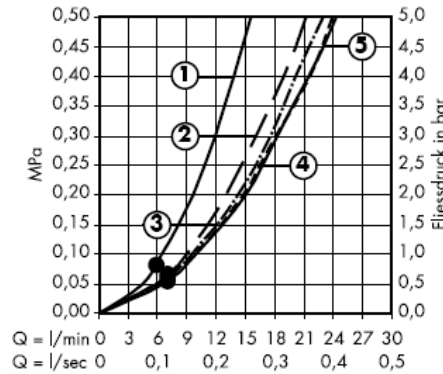

• A partir deste ponto inicia-se o funcionamento correcto.

Com o filtro (A)

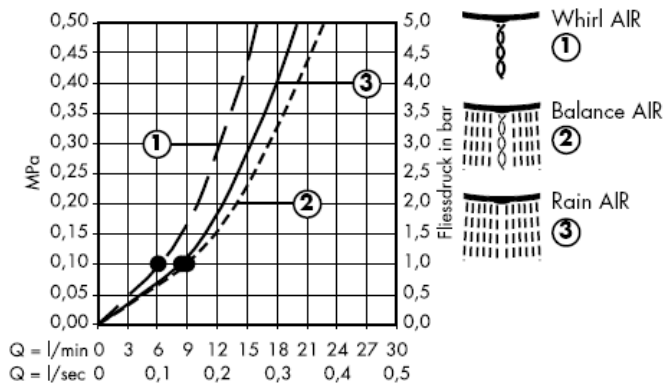

Com o filtro de junção (B)

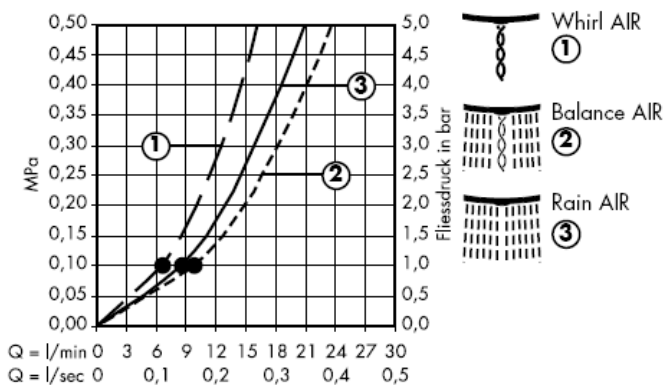

- A partir deste ponto inicia-se o funcionamento correcto.

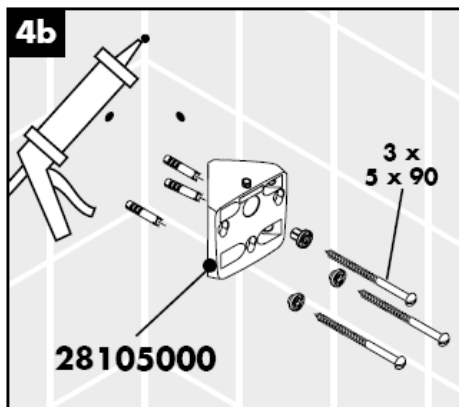
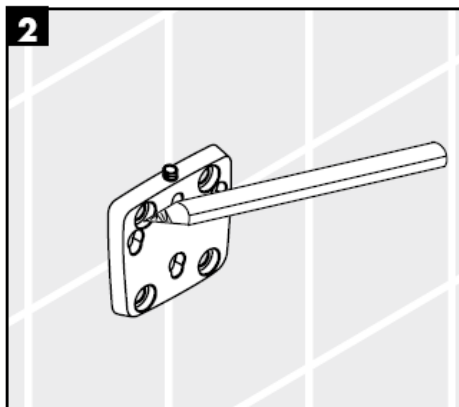

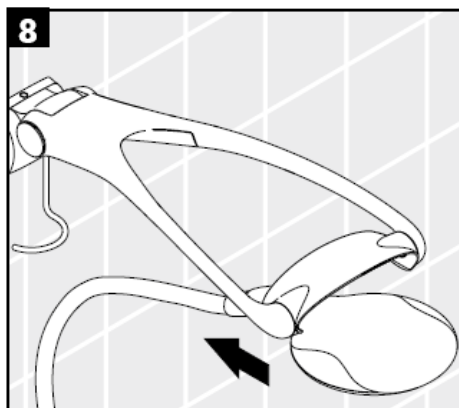
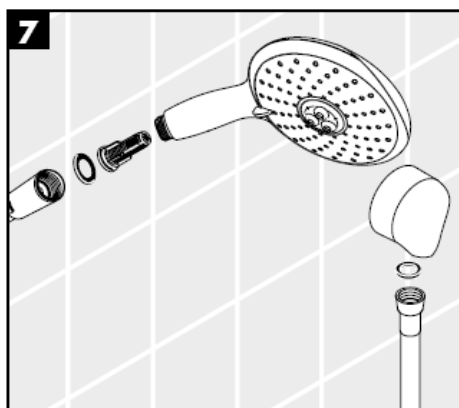
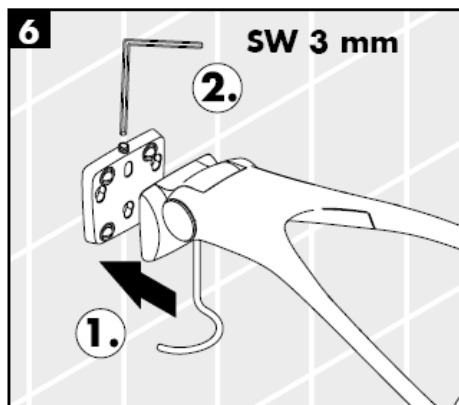

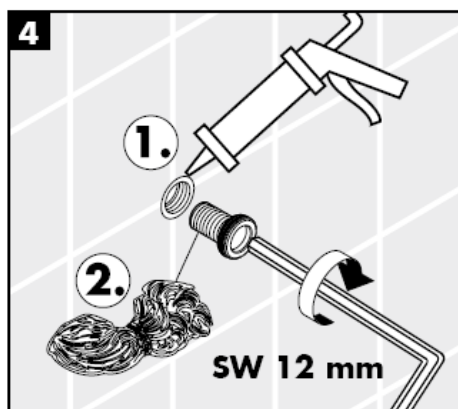
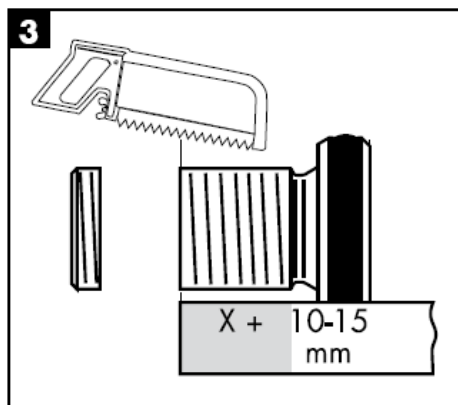
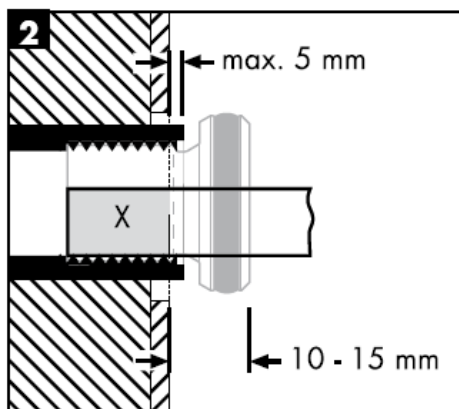
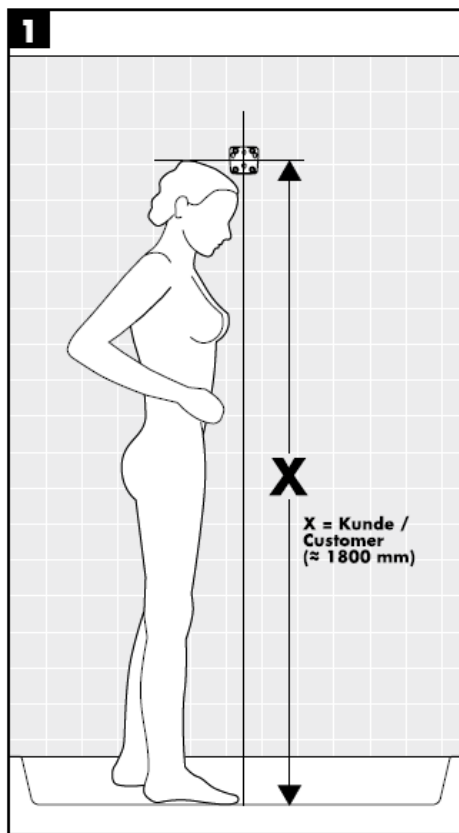

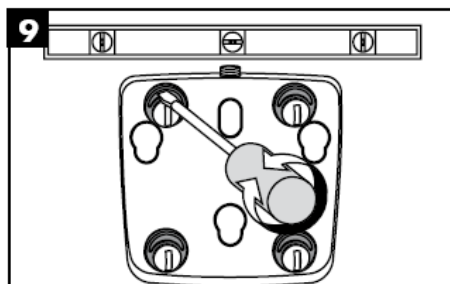
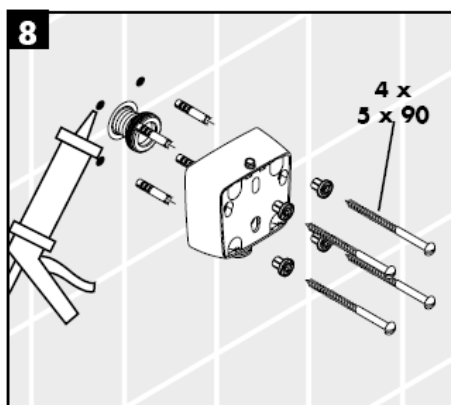
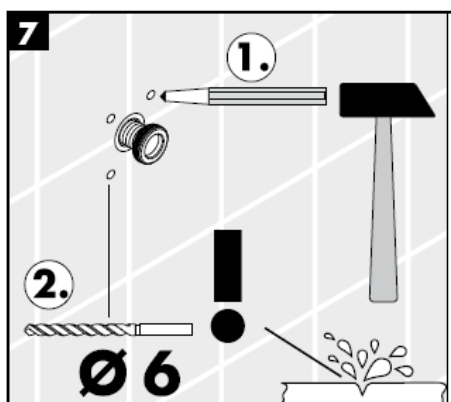
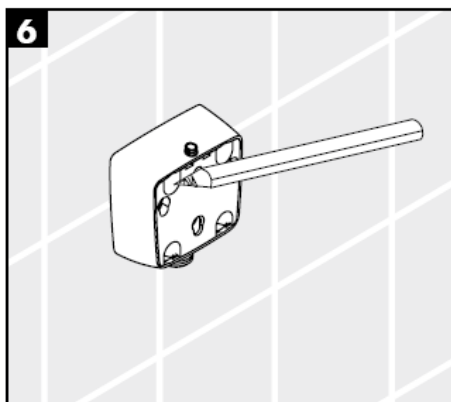

Com o encaixe excêntrico é possível compensar a tolerância da furação.

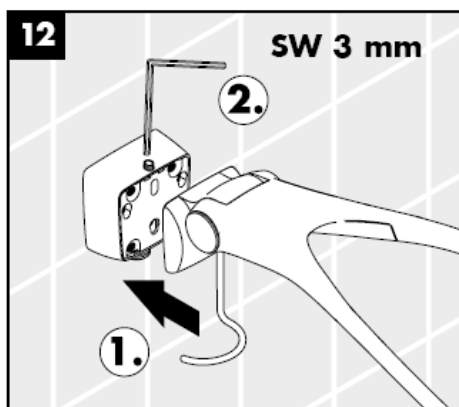
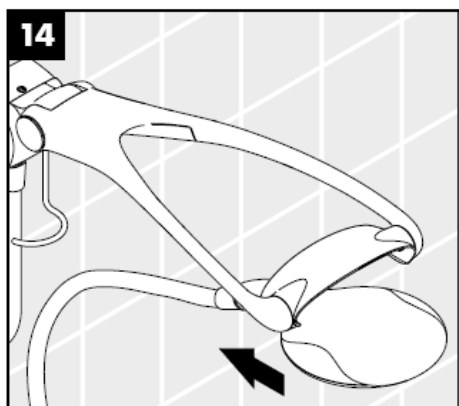
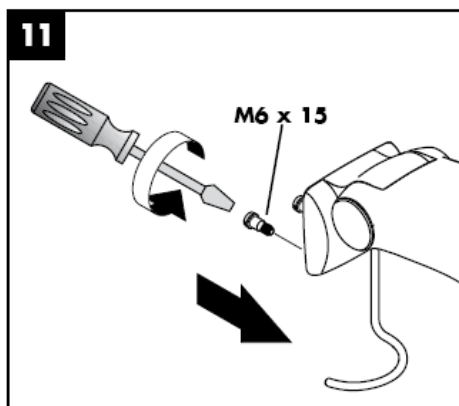
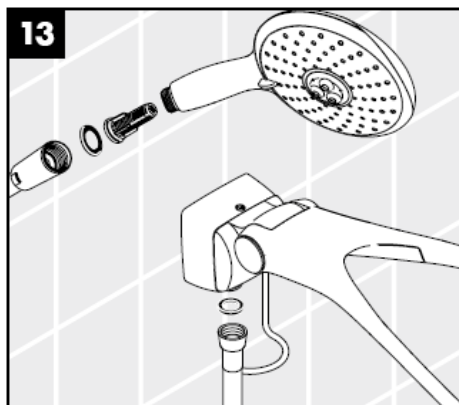
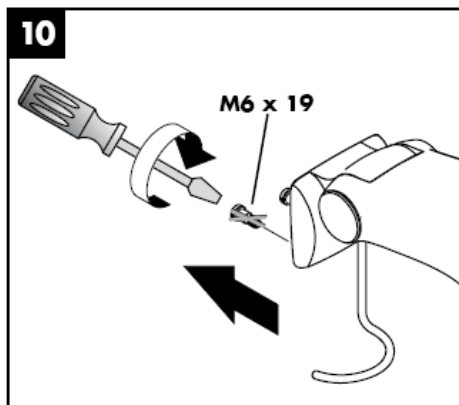



O set Allrounder é um sistema de duche multifuncional. Permite o uso como chuveiro de parede, jactos laterais ou chuveiro de mão separado, dependendo da posição do suporte.

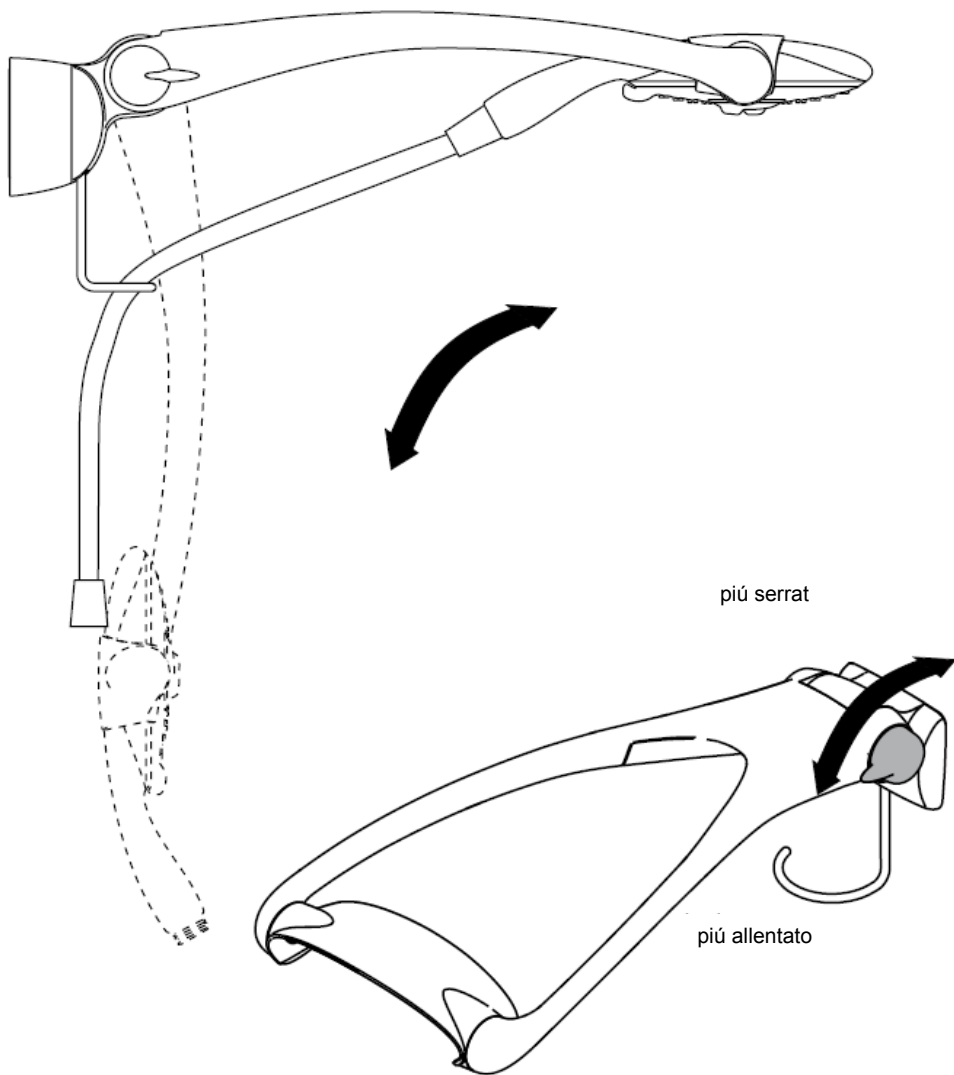

Limpeza

O sistema de limpeza Rubit® requer apenas uma ligeira passagem com a mão para remover os depósitos de calcário do emulsor.

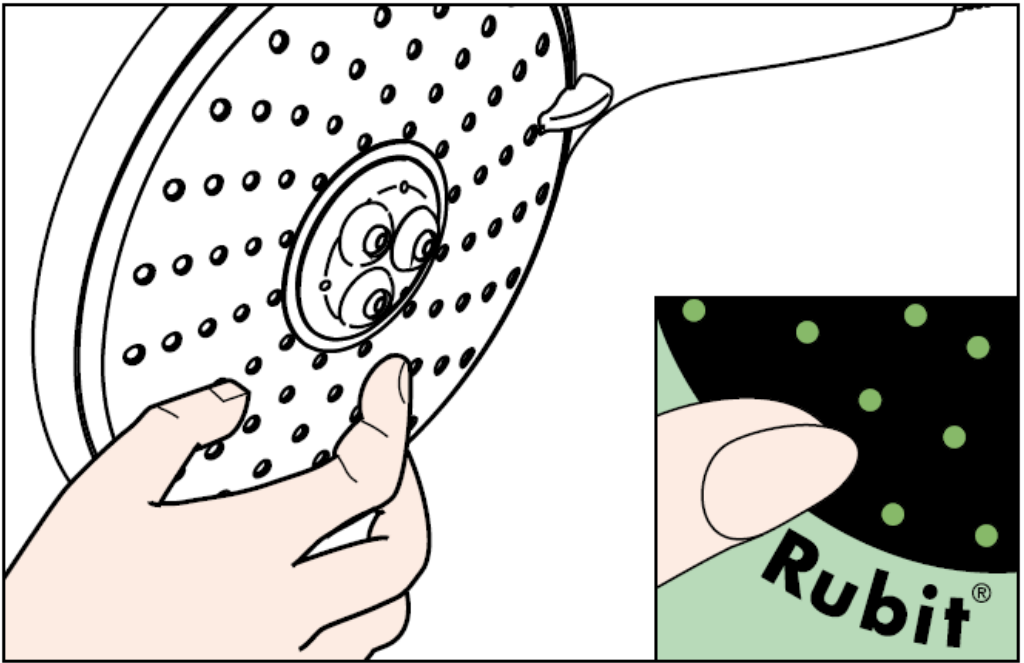

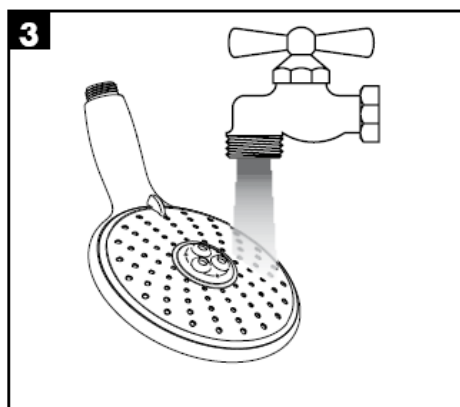
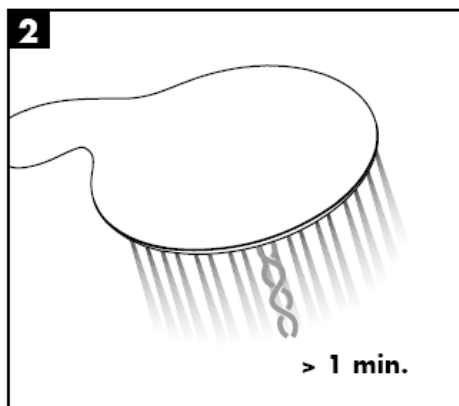
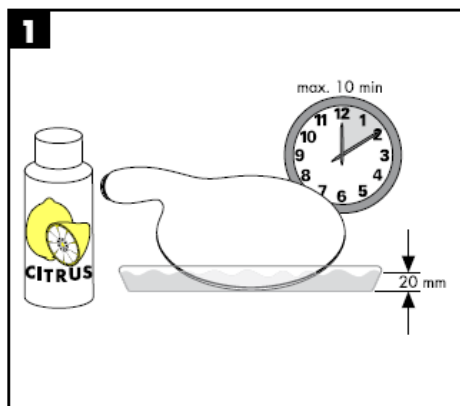

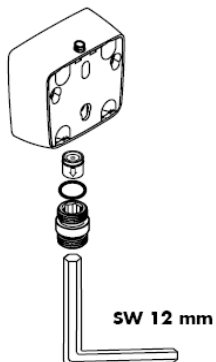

Atenção!

As válvulas anti-retorno têm que ser verificadas uma vez por ano.

hansgrohe

Hansgrohe · Postfach 1145 · D-77761 Schiltach · Telefon +49 (0) 78 36/51-1282 · Telefax +49 (0) 7836/511440
E-Mail: info@hansgrohe.com · Internet: www.hansgrohe.com

02/2008
9.06081.04
Português

Instrukcja montażu

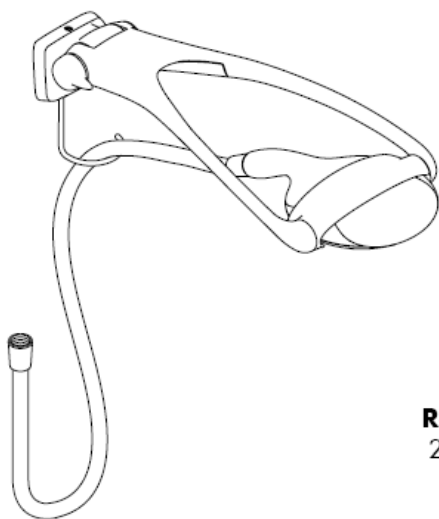

Raindance
28105000

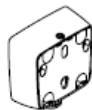

Raindance
28108000

Raindance Allrounder Set
28100000 / 28110000

hansgrohe

Raindance Allrounder Set

28100000 / 28110000

Classification acoustique et débit 28110000: ACS

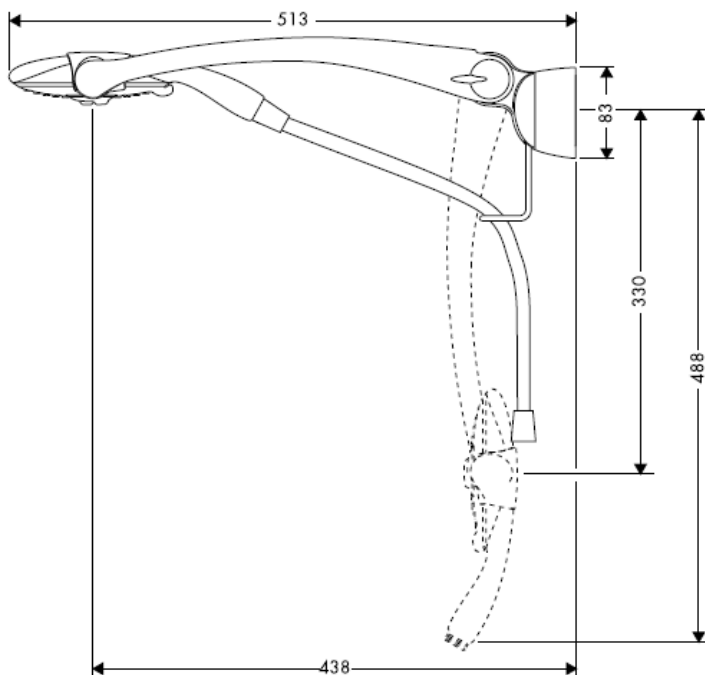

Raindance Eckmontage Set

28105000



Raindance UP-Adapter für Schlauchanschluß

28108000



Raindance Allrounder Set

28100000 / 28110000

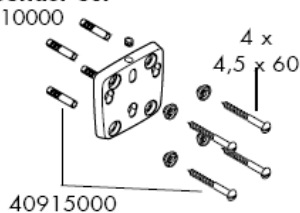

98562000

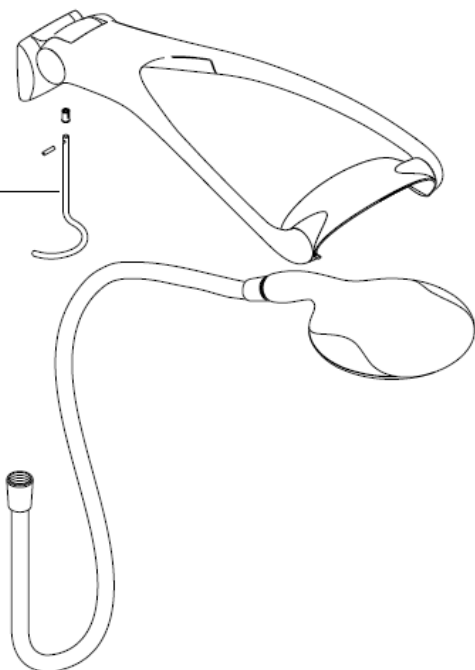

Raindance Eckmontage Set

28105000

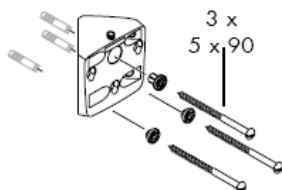

Raindance UP-Adapter für Schlauchanschluss

28108000

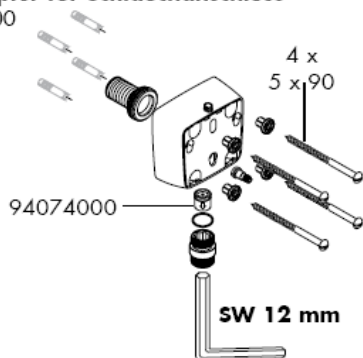

Montaż

Należy zamontować znajdującą się w opakowaniu wkładkę filtra (A), aby zapewnić przepisowy przepływ przez prysznic ręczny i zapobiec przedostawaniu się zanieczyszczeń z instalacji sieciowej. Jeżeli pożądanym jest większy przepływ wody, wówczas należy zamiast wkładki filtra (A) użyć uszczelki z sitkiem (B). Przedostające się zanieczyszczenia mogą mieć negatywny wpływ na działanie i/lub prowadzić do usterek w działaniu elementów prysznica ręcznego. Za powstałe z tego tytułu szkody firma Hansgrohe nie ponosi odpowiedzialności.

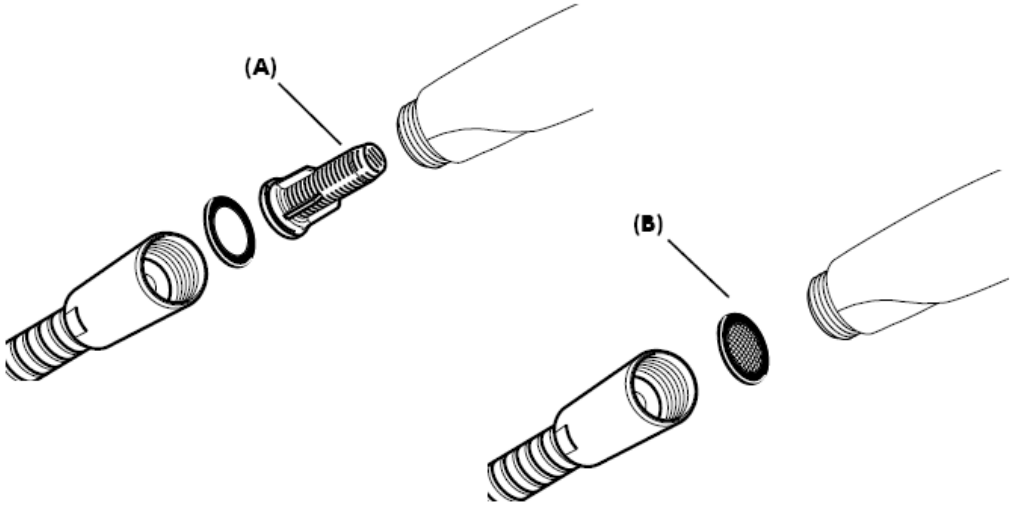

281000000

Z wkładką filtra (A)

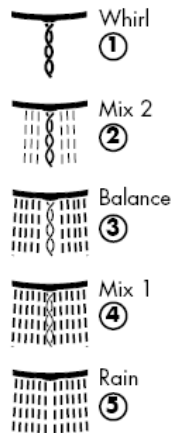
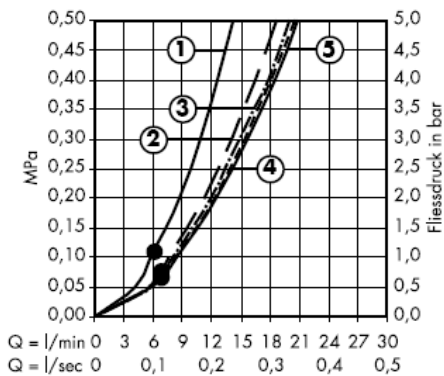

Z uszczelką z sitkiem (B)

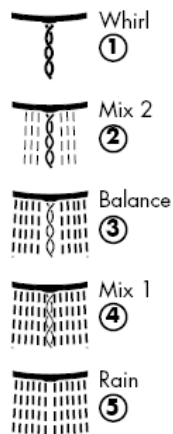
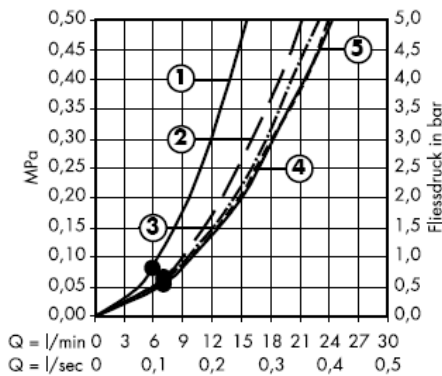

Od • możliwe jest funkcjonowanie.

Z wkładką filtra (A)

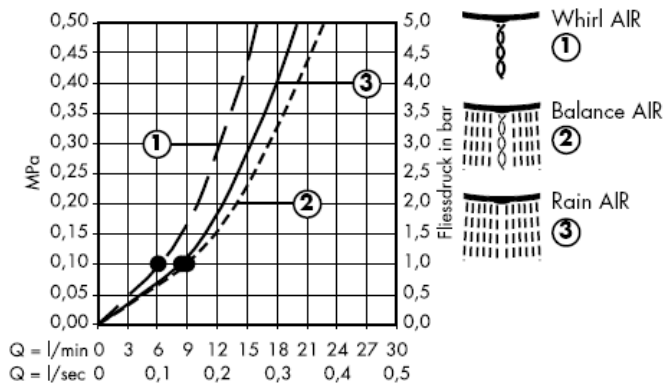

Z uszczelką z sitkiem (B)

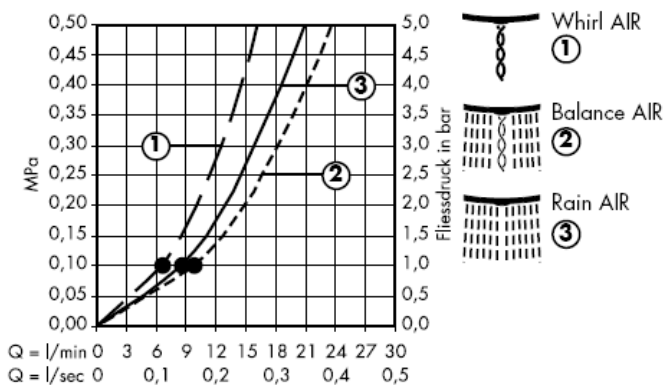

Od • możliwe jest funkcjonowanie.

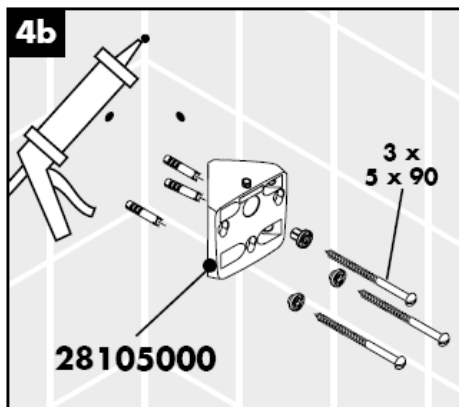
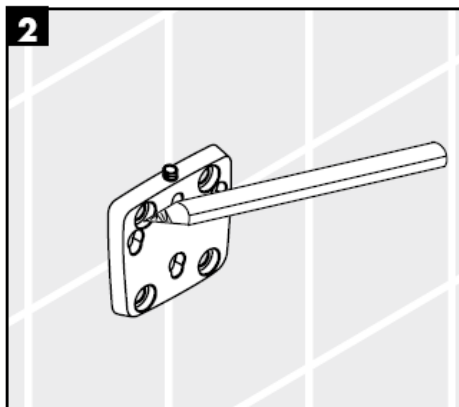

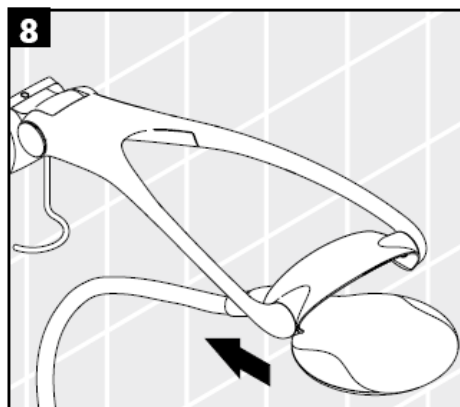
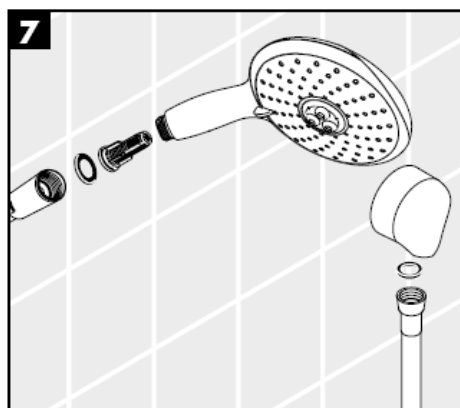
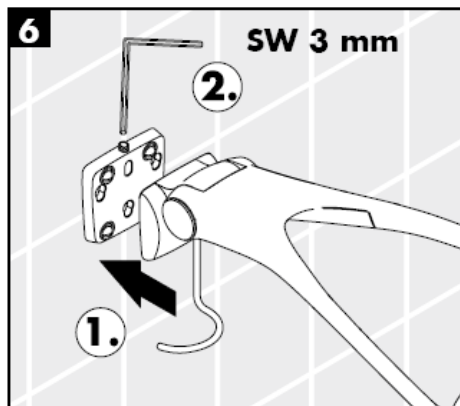

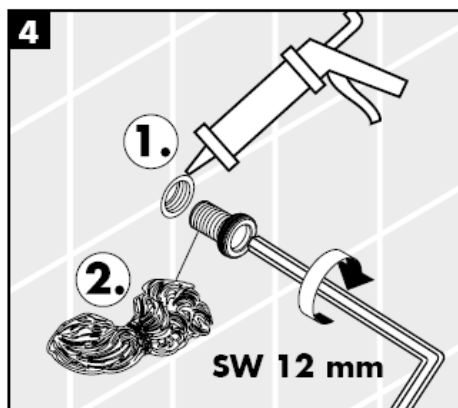
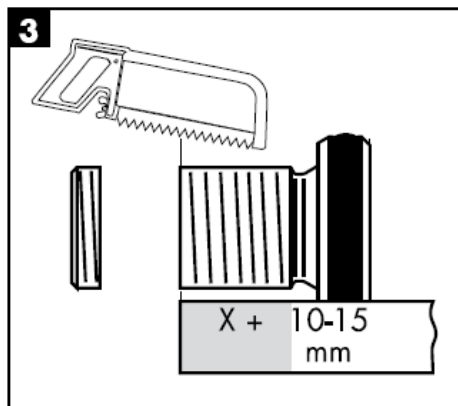
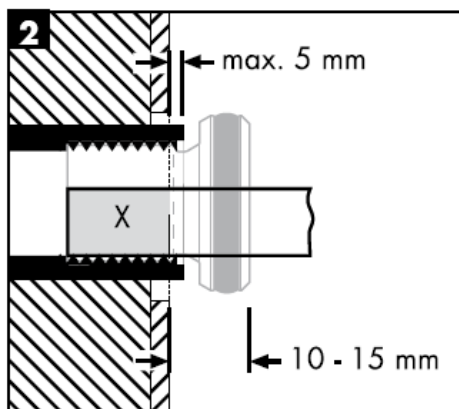
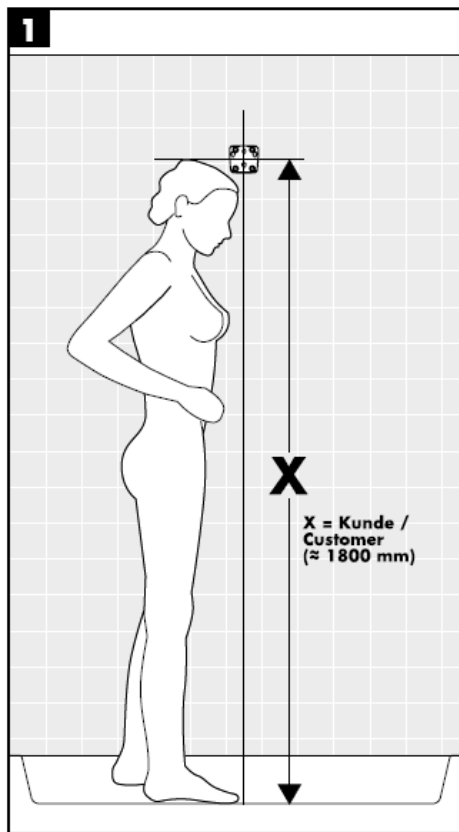

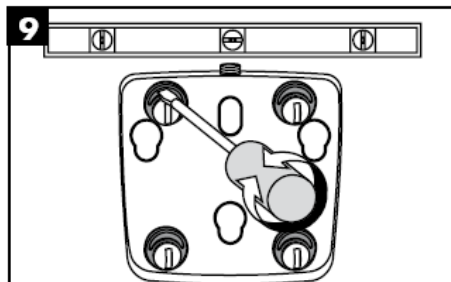
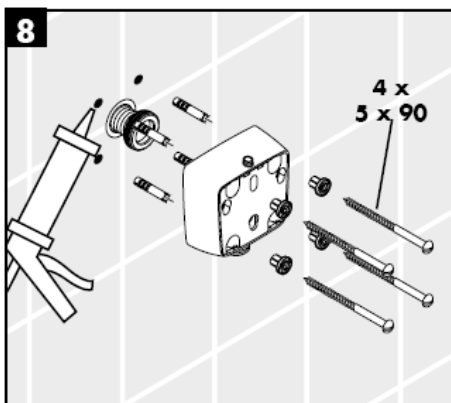
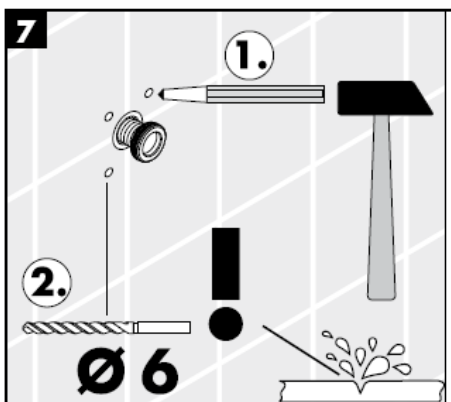
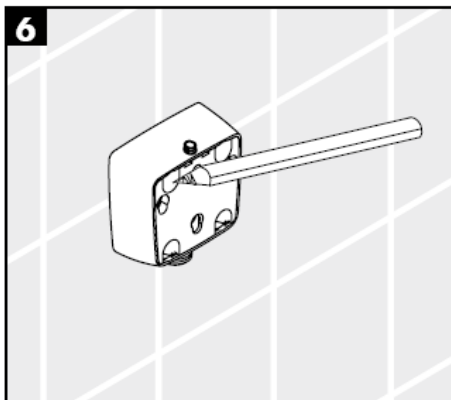

Za pomocą tulei mimośrodowej można łatwo wyrównać tolerancje otworów.





Zestaw Allrounder jest wielosystemowym zestawem prysznicowym. W zależności od ustawienia uchwytu, można używać funkcji prysznica sufitowego lub bocznego albo też oddzielnego prysznica ręcznego.

Regulacja

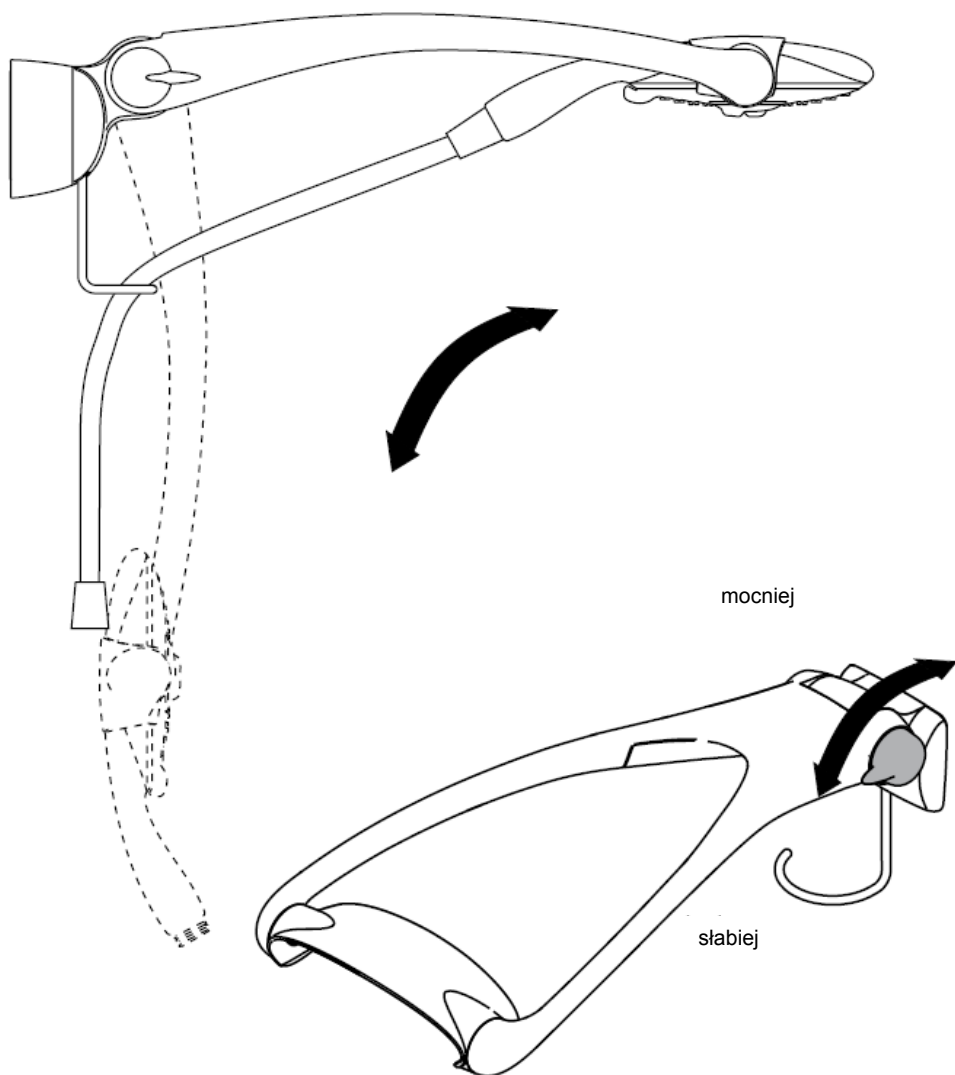

Funkcja Rubit® wymaga jedynie delikatnego potarcia dłonią, aby usunąć ewentualne osady kamienia wapiennego.

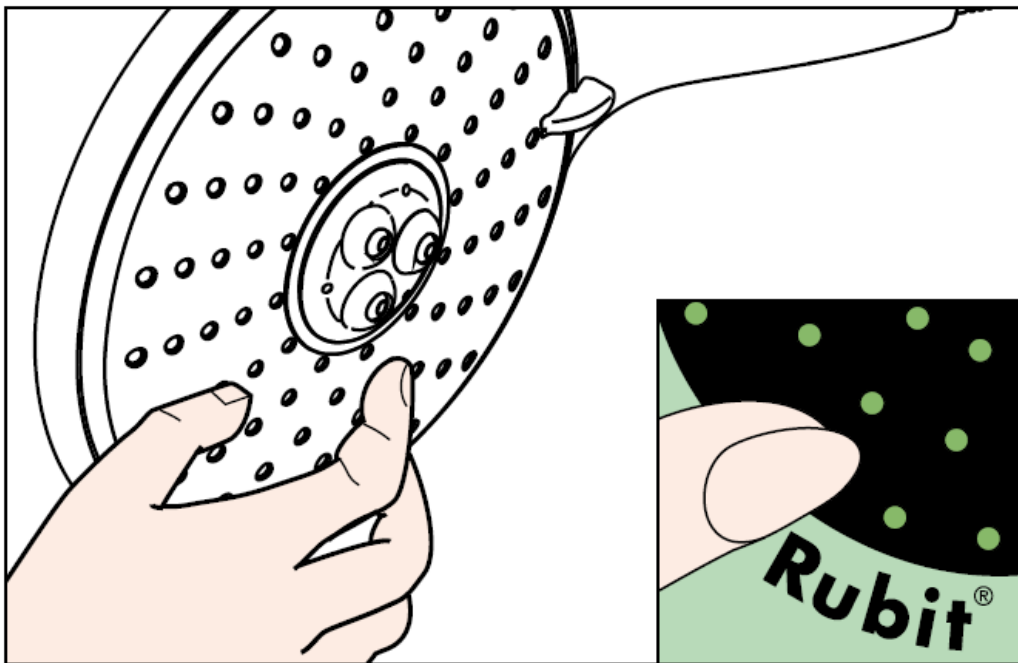

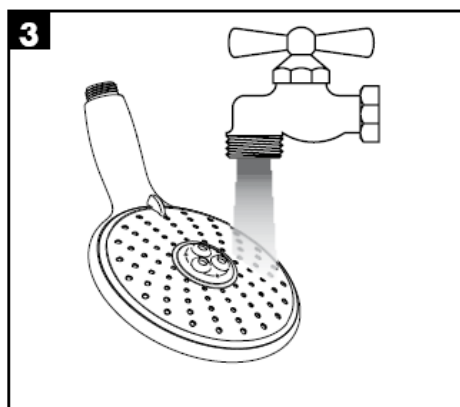
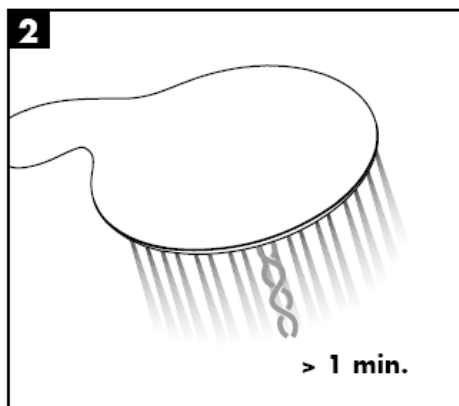
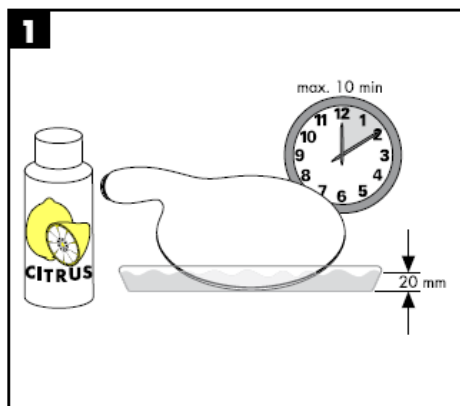

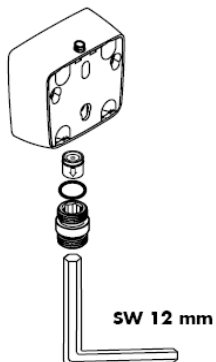

Uwaga!

Zgodnie z normą DIN 1988 działanie zabezpieczeń przepływu zwrotnego należy skontrolować raz w roku.

hansgrohe

Hansgrohe · Postfach 1145 · D-77761 Schiltach · Telefon +49 (0) 78 36/51-1282 · Telefax +49 (0) 7836/511440
E-Mail: info@hansgrohe.com · Internet: www.hansgrohe.com

02/2008
9.06081.04
Polski

Montážní návod

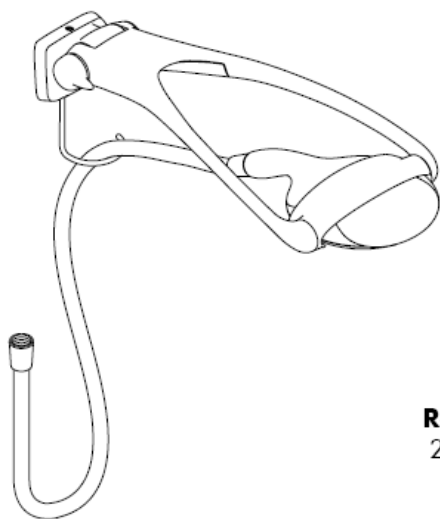

Raindance
28105000

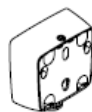

Raindance
28108000

Raindance Allrounder Set
28100000 / 28110000

hansgrohe

Raindance Allrounder Set

28100000 / 28110000

Classification acoustique et débit 28110000: ACS

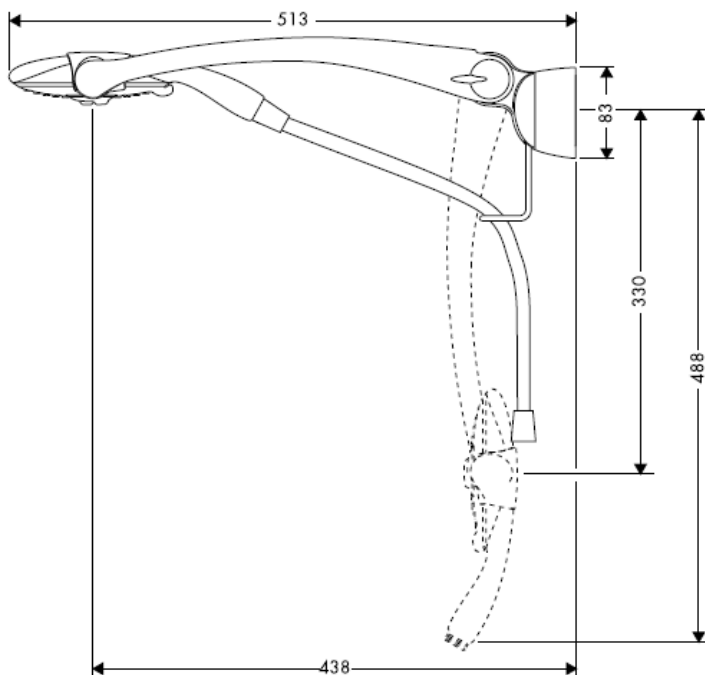

Raindance Eckmontage Set

28105000



Raindance UP-Adapter für Schlauchanschluß

28108000



Raindance Allrounder Set

28100000 / 28110000

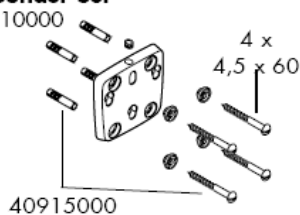

98562000

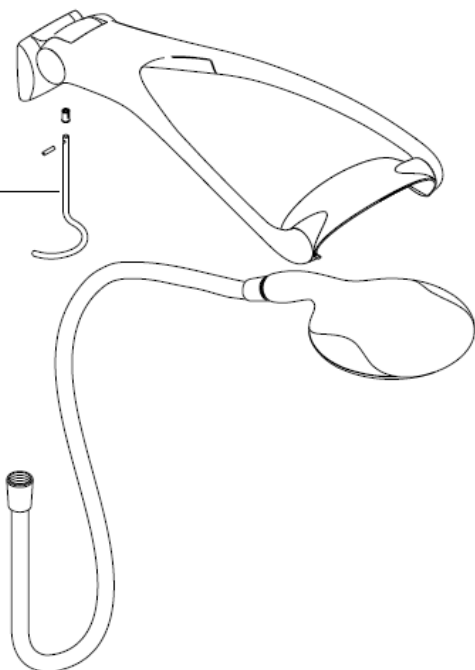

Raindance Eckmontage Set

28105000

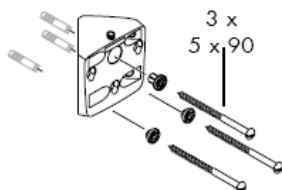

Raindance UP-Adapter für Schlauchanschluss

28108000

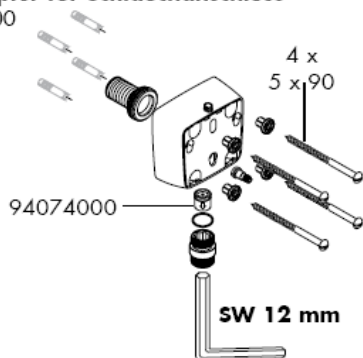

Montáž

Příbalená filtrační vložka (A) se musí zabudovat, aby zajistila jmenovitý průtok ruční sprchou a zabránila přístupu nečistot vyplavovaných z potrubí. Pokud se požaduje vyšší průtok, musí se vsadit místo filtrační vložky (A) těsnění se sítkem (B). Vyplavené nečistoty mohou ovlivnit funkčnost a nebo také vést k poškození funkčních dílů ruční sprchy. Na tyto škody se záruka firmy Hansgrohe nevztahuje.

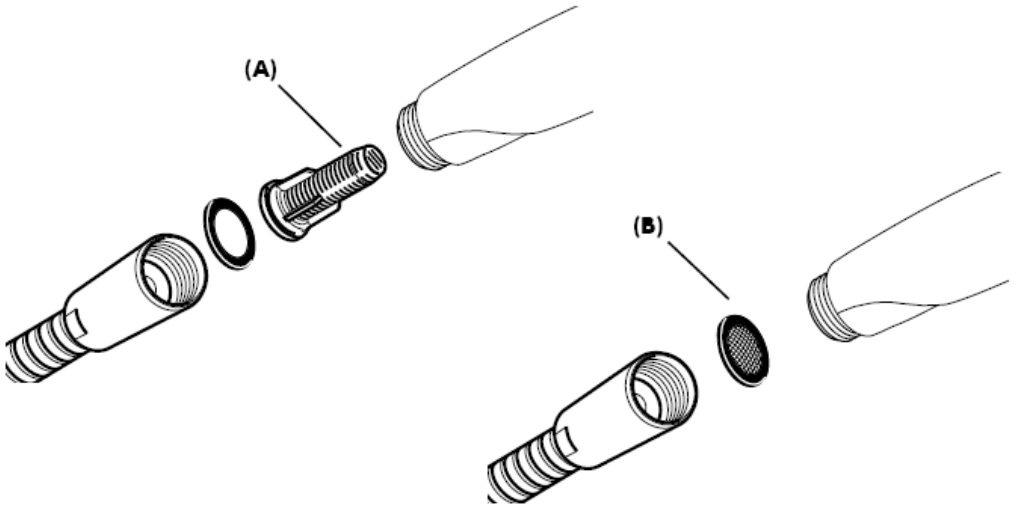

281000000

s filtrační vložkou (A)

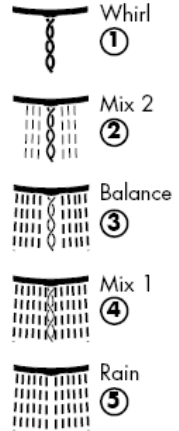
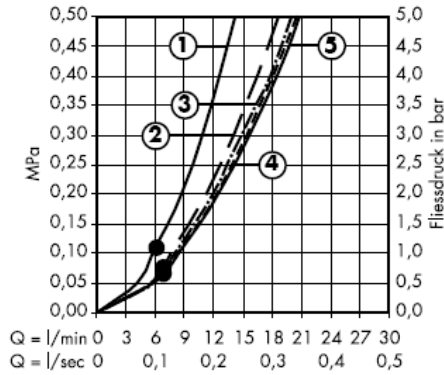

S těsněním se sítkem (B)

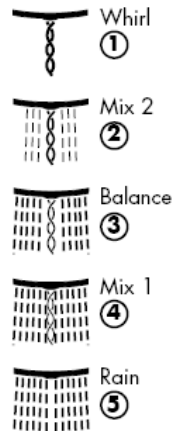
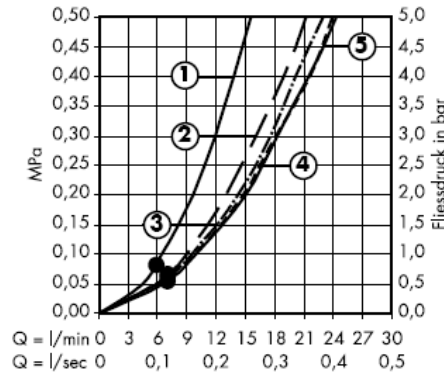

Od • je zaručená funkce

s filtrační vložkou (A)

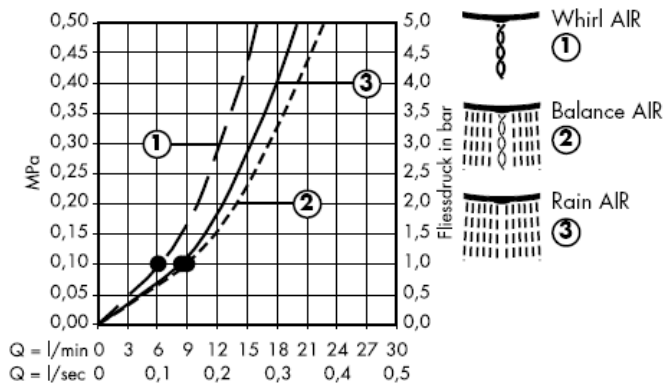

S těsněním se sítkem (B)

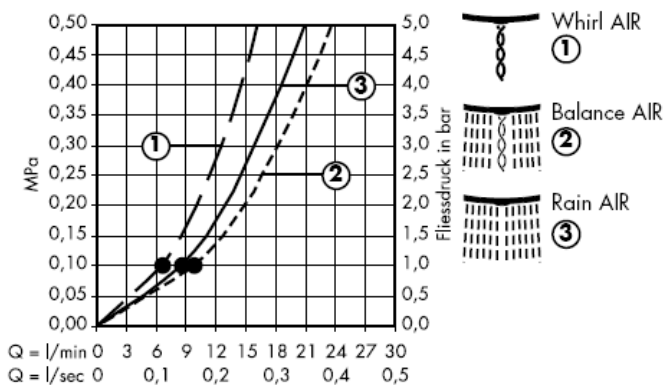

Od • je zaručená funkce

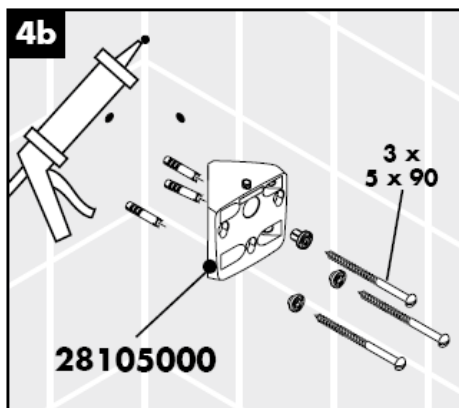
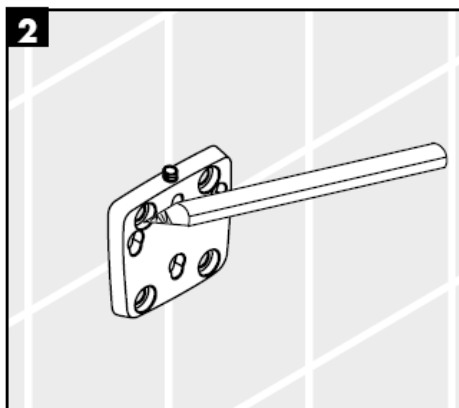

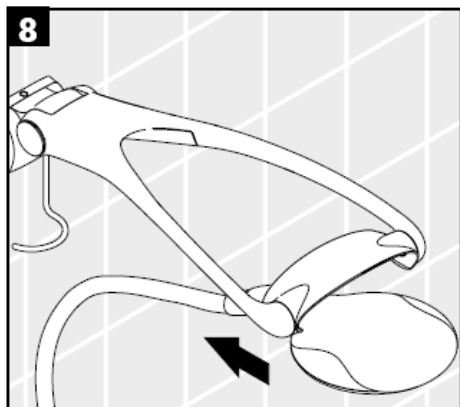
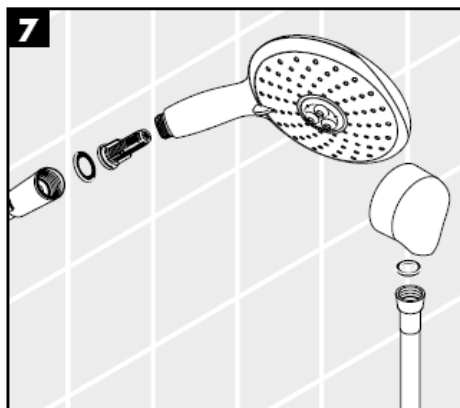
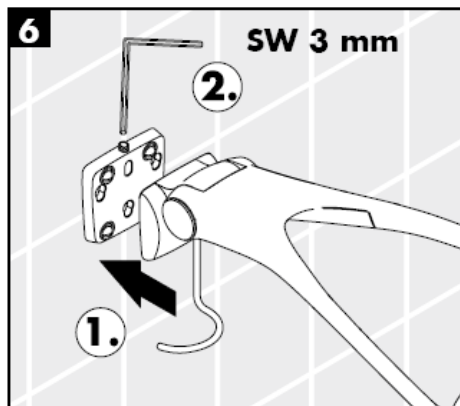

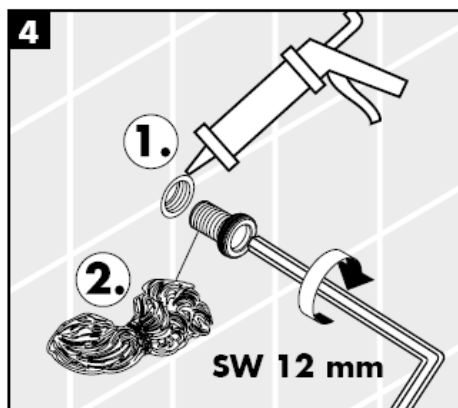
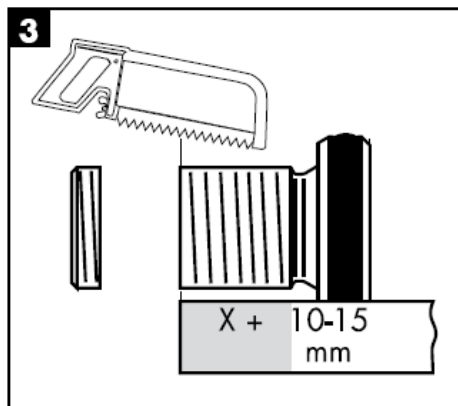
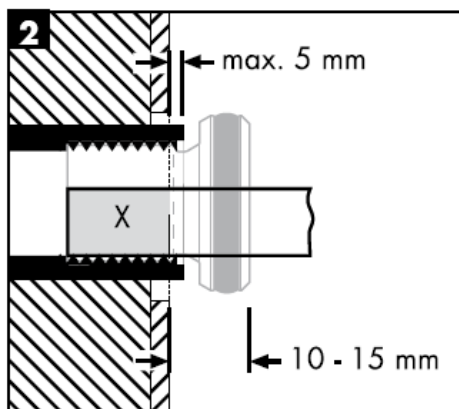
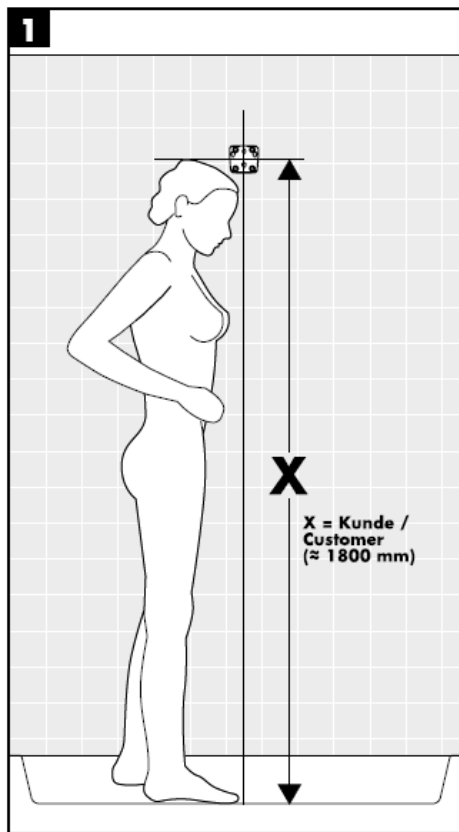

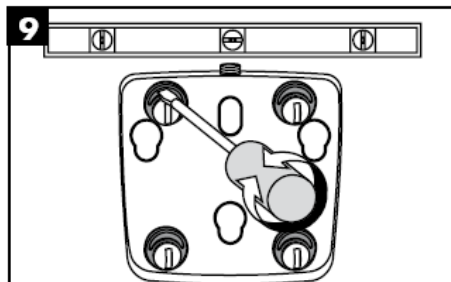
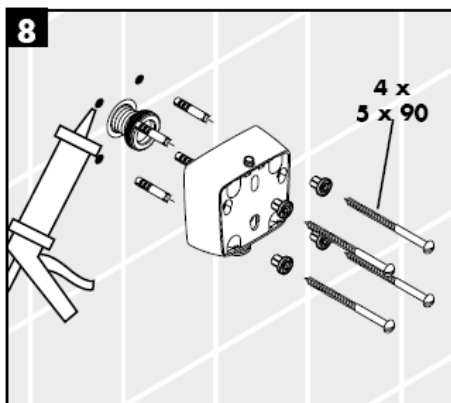
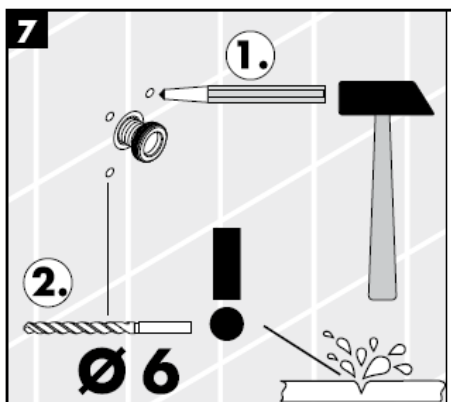
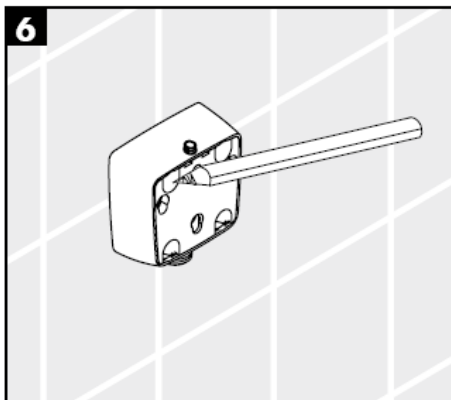

Excentrickými vložkami je možné vyrovnat tolerance vrtaných otvorů.





Sada Allrounder je vícefunkčním sprchovým systémem. Podle nastavení páky jej můžete používat ve funkci horní sprchy nebo boční sprchy nebo také jako samostatnou ruční sprchu.

Nastavení

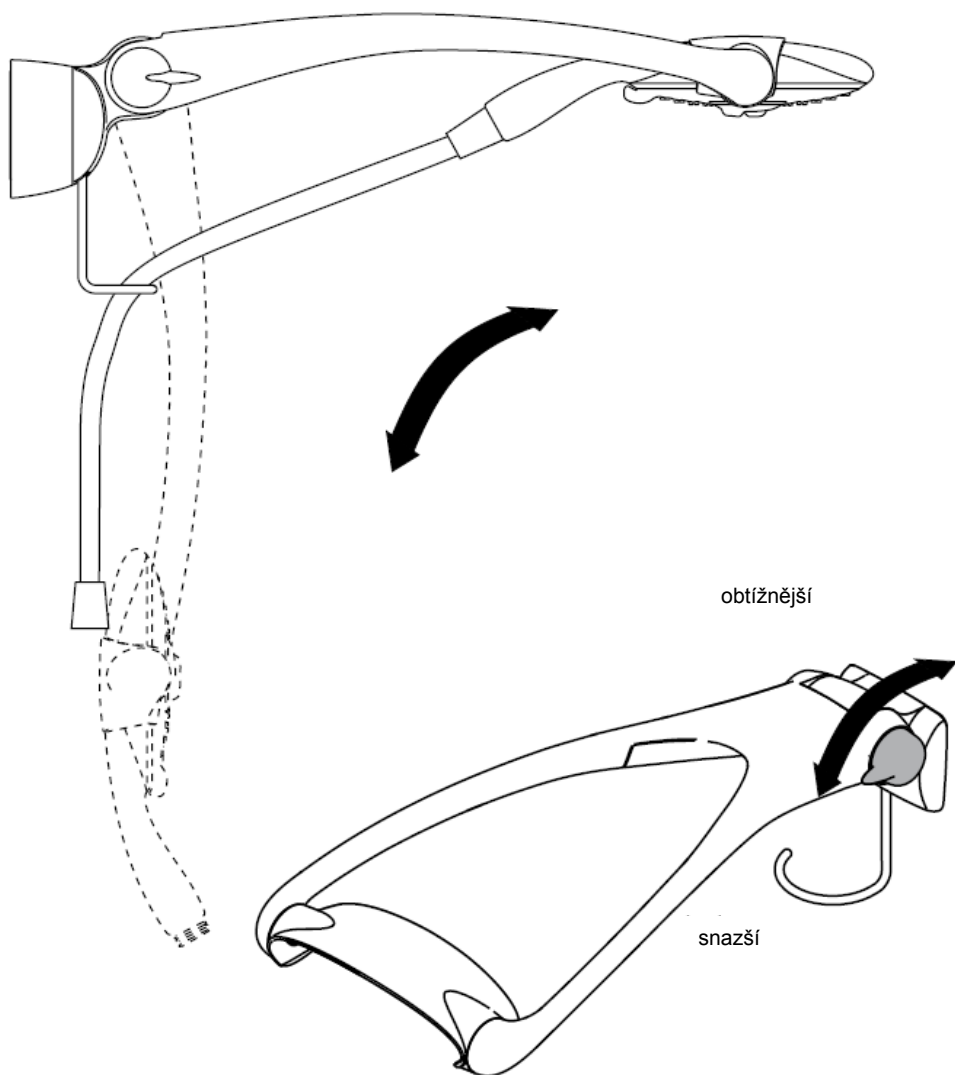

S ruční čisticí funkcí Rubit® stačí jednoduché odstranění vodního kamene prsty z trysky kotouče tvarujícího proud vody.

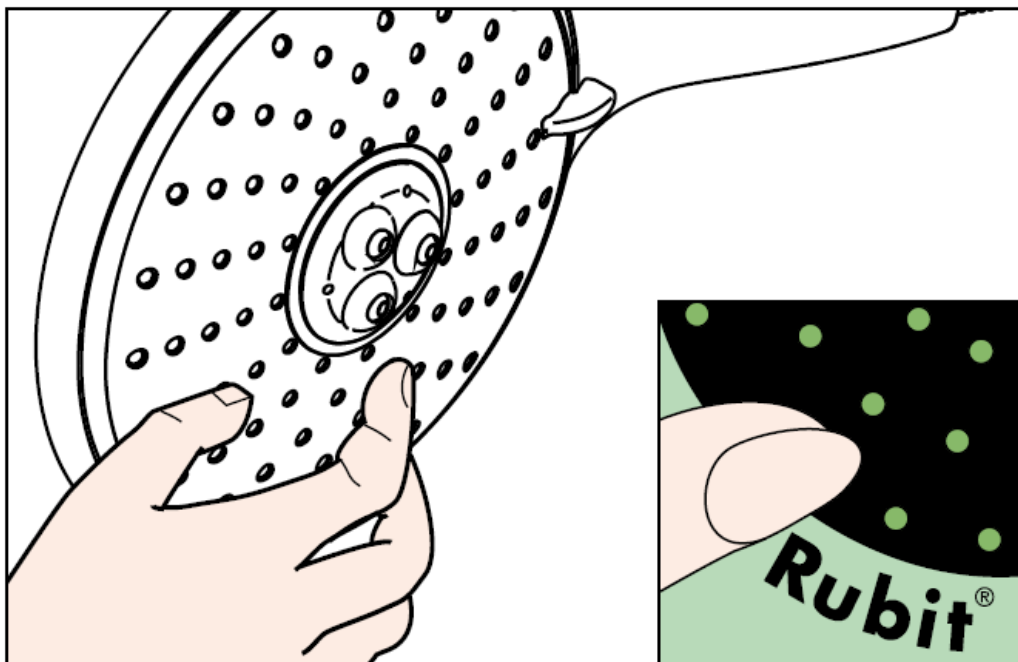

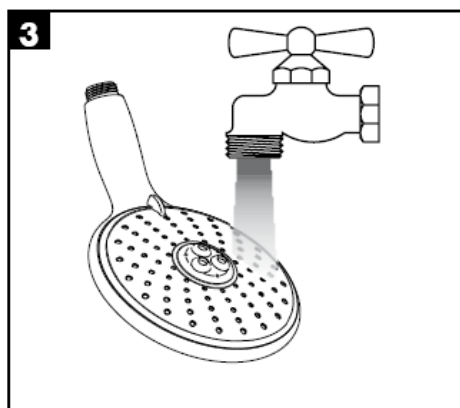
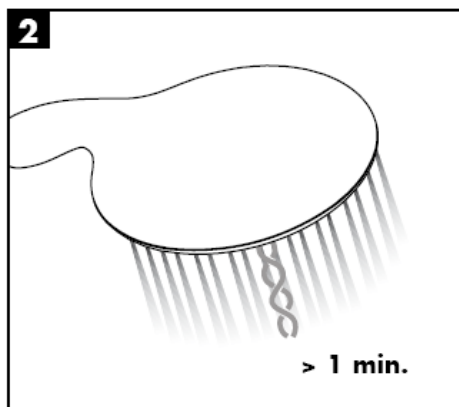
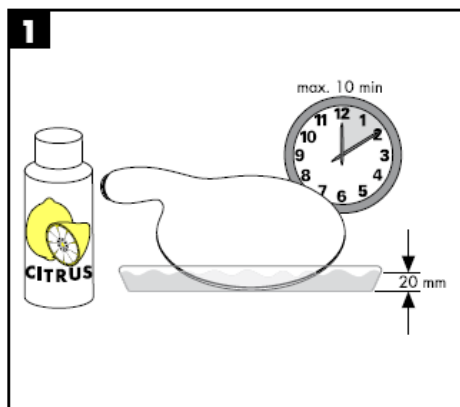

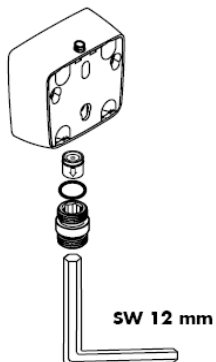

Pozor!

U jistění proti zpětnému nasátí musí být podle normy DIN 1988 jednou ročně přezkoušena jeho funkce.

hansgrohe

Hansgrohe · Postfach 1145 · D-77761 Schiltach · Telefon +49 (0) 78 36/51-1282 · Telefax +49 (0) 7836/511440
E-Mail: info@hansgrohe.com · Internet: www.hansgrohe.com

02/2008
9.06081.04
Česky

Montážny návod

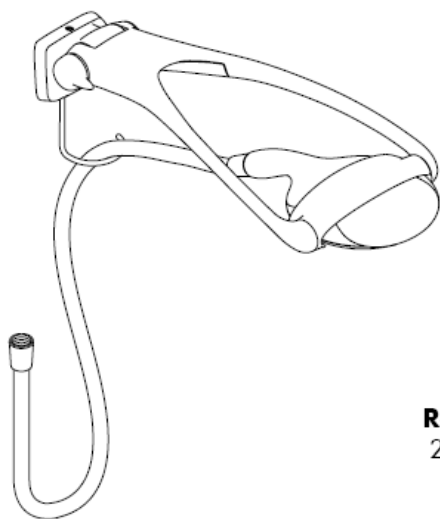

Raindance
28105000

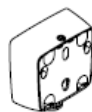

Raindance
28108000

Raindance Allrounder Set
28100000 / 28110000

hansgrohe

Raindance Allrounder Set

28100000 / 28110000

Classification acoustique et débit 28110000: ACS

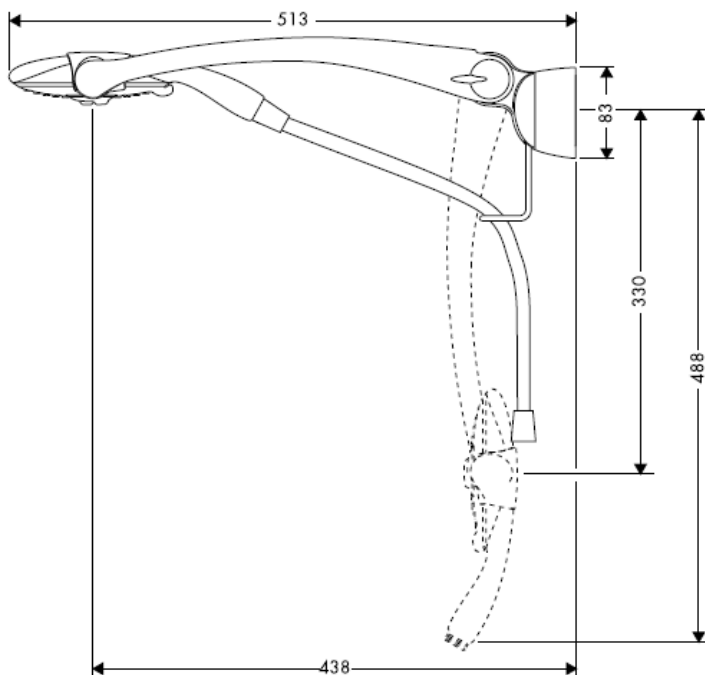

Raindance Eckmontage Set

28105000



Raindance UP-Adapter für Schlauchanschluß

28108000



Raindance Allrounder Set

28100000 / 28110000

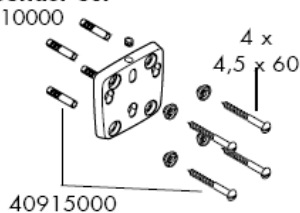

98562000

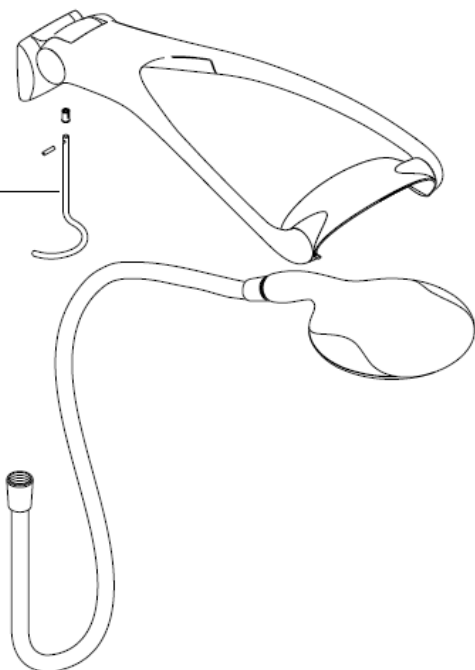

Raindance Eckmontage Set

28105000

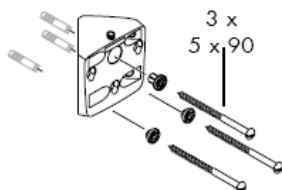

Raindance UP-Adapter für Schlauchanschluss

28108000

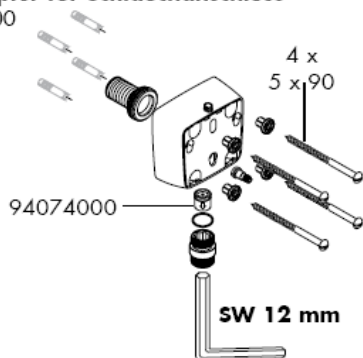

Montáž

Pribalená filtračná vložka (A) sa musí zabudovať, aby zaistila menovitý prietok ručnou sprchou a zabránila prístupu nečistôt vyplavovaných z potrubia.

Pokiaľ sa požaduje vyšší prietok, musí sa vsadiť namiesto filtračnej vložky (A) tesnenie so sitkom (B). Vyplavené nečistoty môžu ovplyvniť funkčnosť alebo môžu viesť aj k poškodeniu funkčných dielov ručnej sprchy. Na tieto škody sa záruka firmy Hansgrohe nevzťahuje.

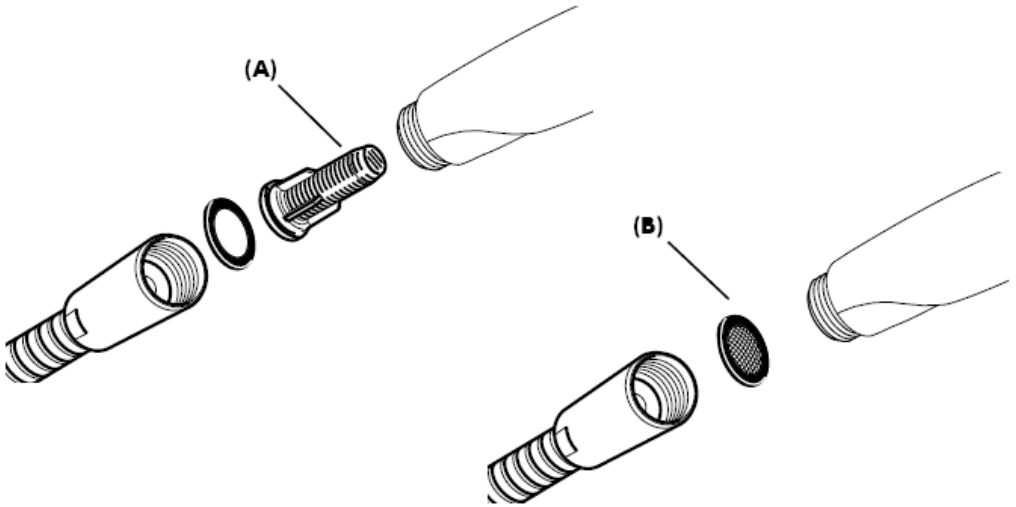

281000000

S filtračnou vložkou (A)

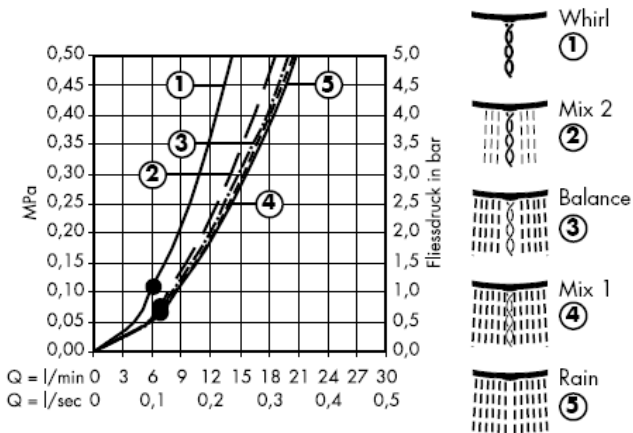

S tesnením so sitkom (B)

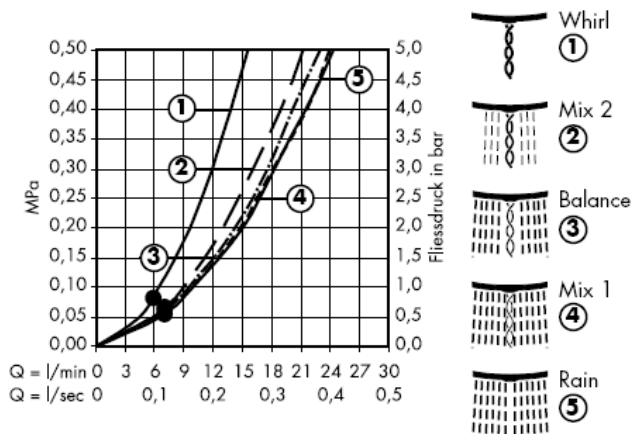

Od • je zaručená funkcia.

S filtračnou vložkou (A)

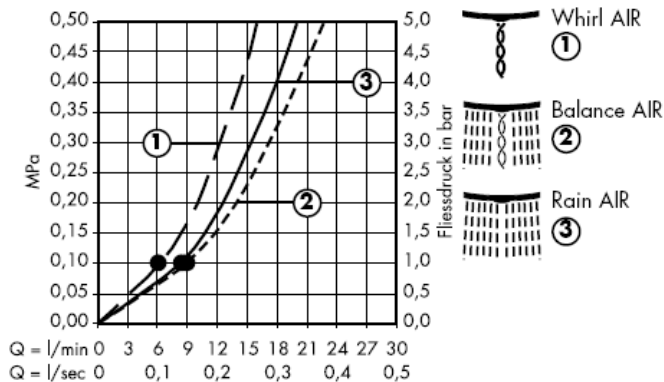

S tesnením so sítom (B)

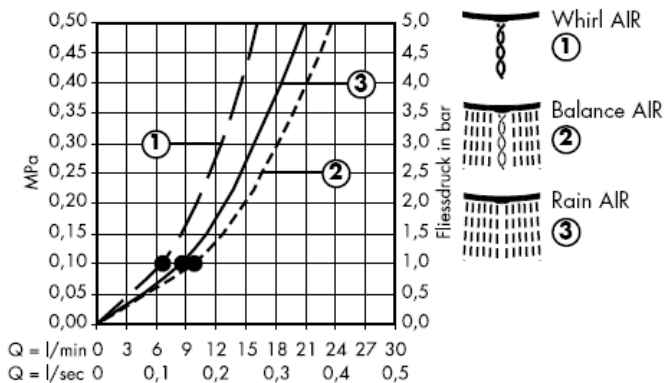

Od • je zaručená funkcia.

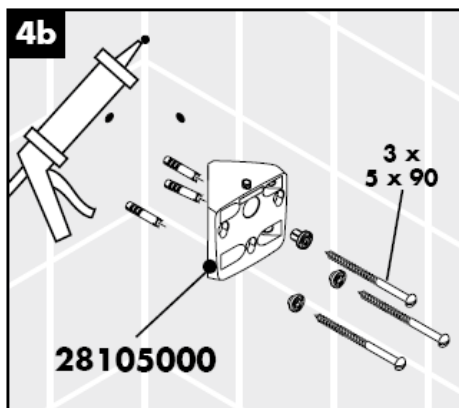
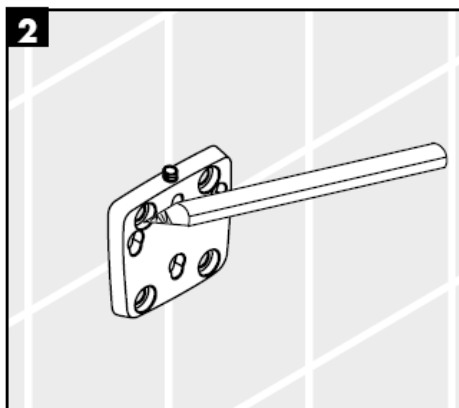

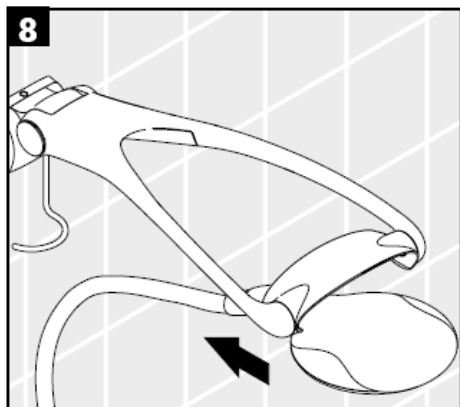
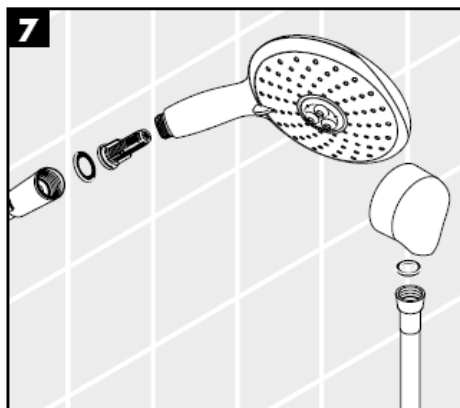
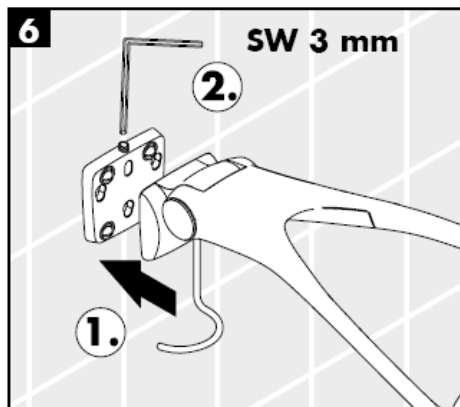

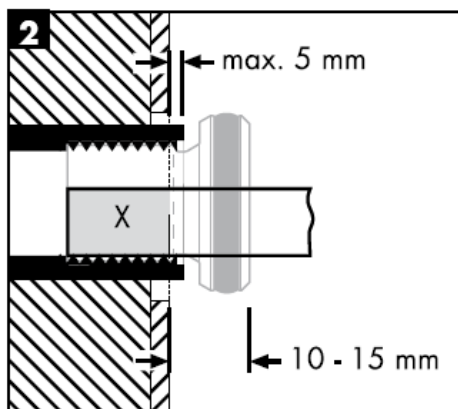
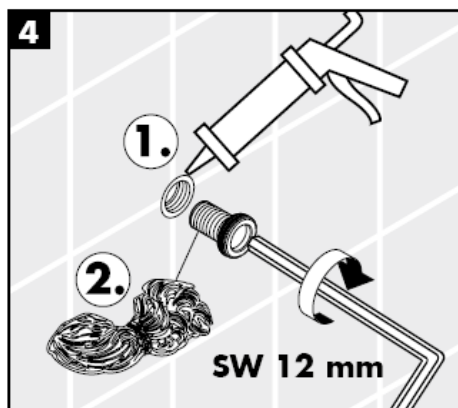
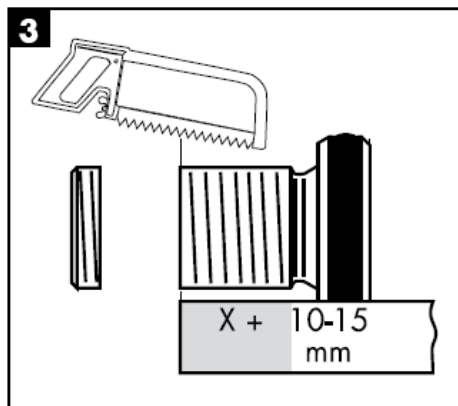
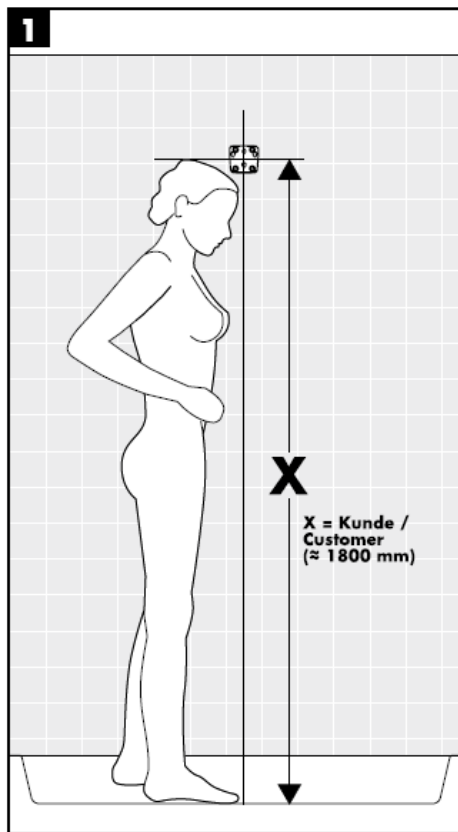

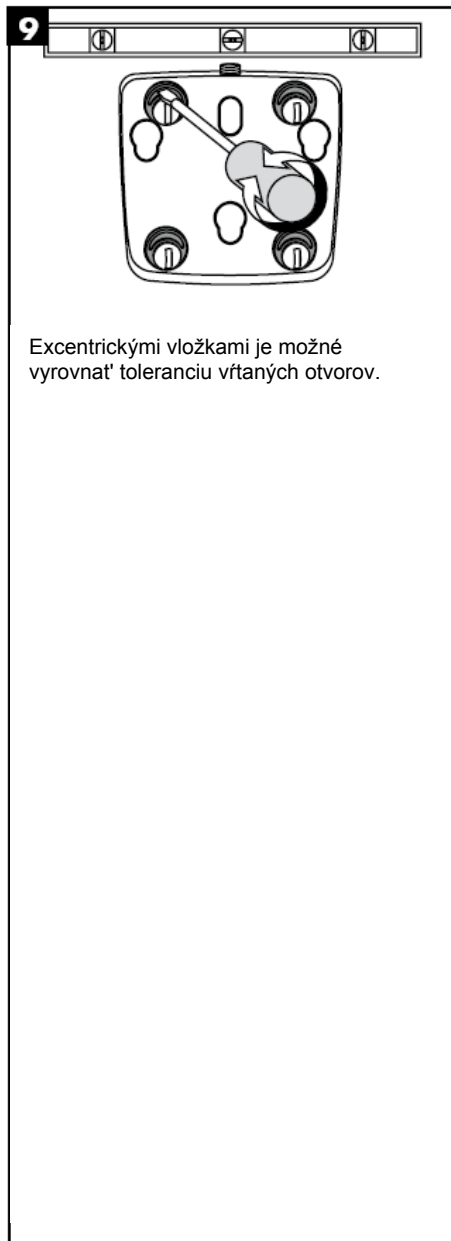
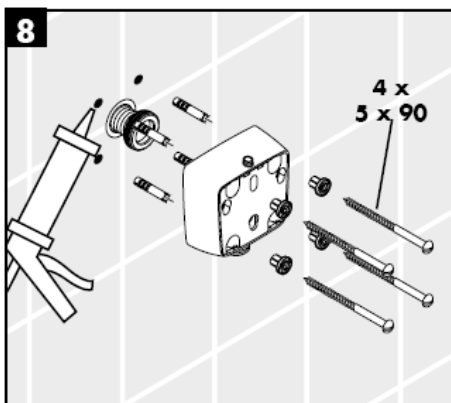
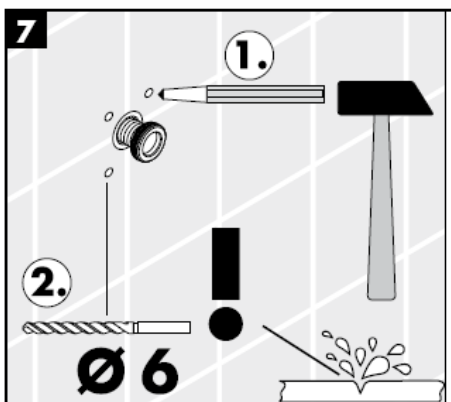
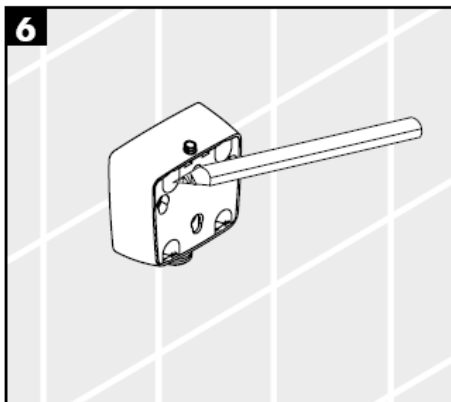





Komplet Allrounder je viacfunkčné sprchovacie zariadenie. Podľa nastavenia ramena páky ho môžete používať ako hornú sprchu, ako bočné sprchy, alebo ako samostatnú ručnú sprchu.

Nastavenie

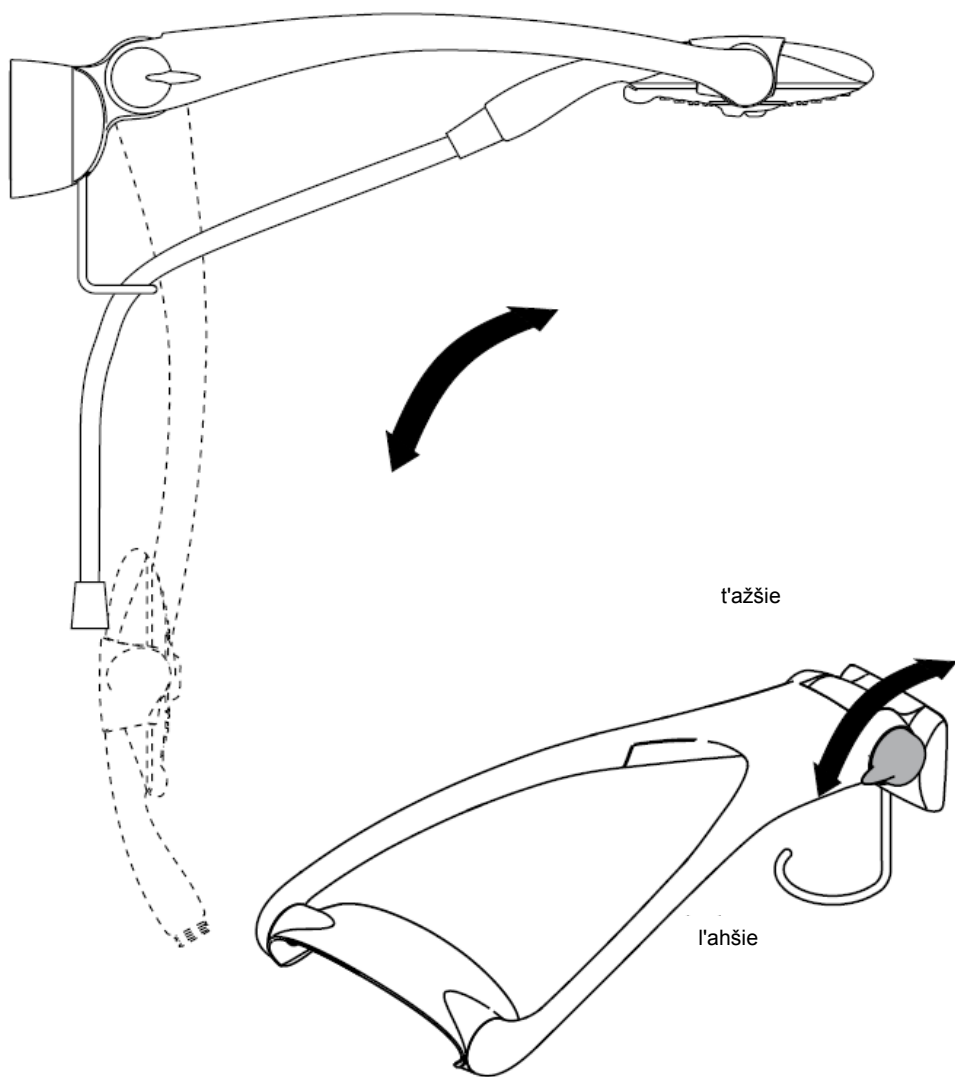

Čistiaca funkcia Rubit, stačí na jednoduché odstránenie vodného kameňa prstami z trysiek kotúča tvarujúceho prúd vody.

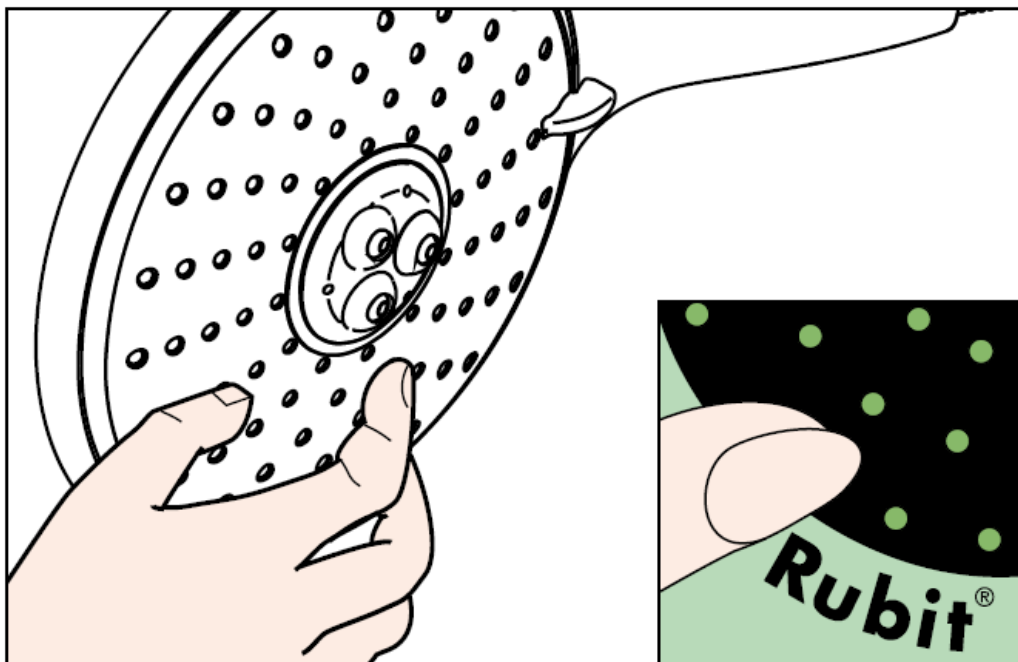

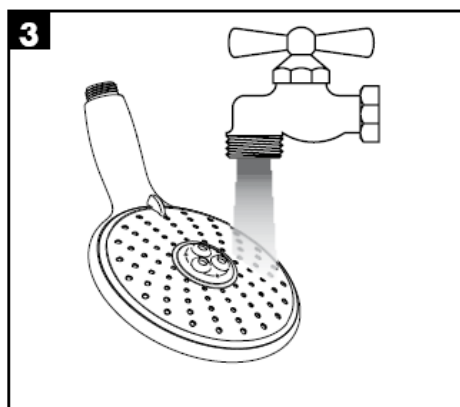
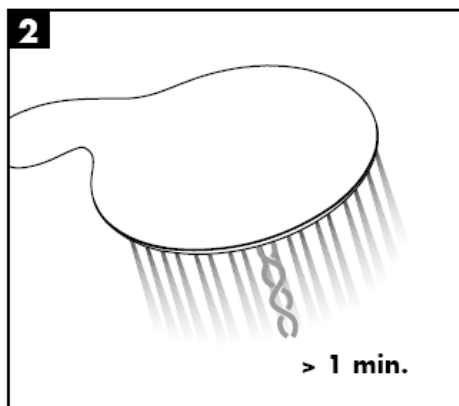
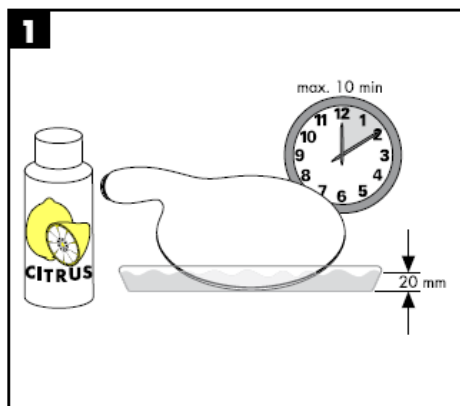

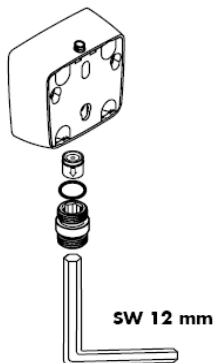

Pozor!

Pri poistke proti spätnému nasatiu musí byť podľa normy DIN 1988 raz ročne preskúšaná jej funkčnosť.

hansgrohe

Hansgrohe · Postfach 1145 · D-77761 Schiltach · Telefon +49 (0) 78 36/51-1282 · Telefax +49 (0) 7836/511440
E-Mail: info@hansgrohe.com · Internet: www.hansgrohe.com

02/2008
9.06081.04
Slovensky

组装说明

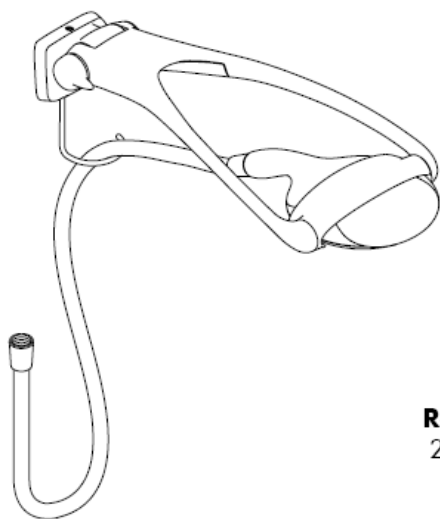

Raindance
28105000

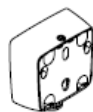

Raindance
28108000

Raindance Allrounder Set
28100000 / 28110000

hangrohe

Raindance Allrounder Set

28100000 / 28110000

Classification acoustique et débit 28110000: ACS

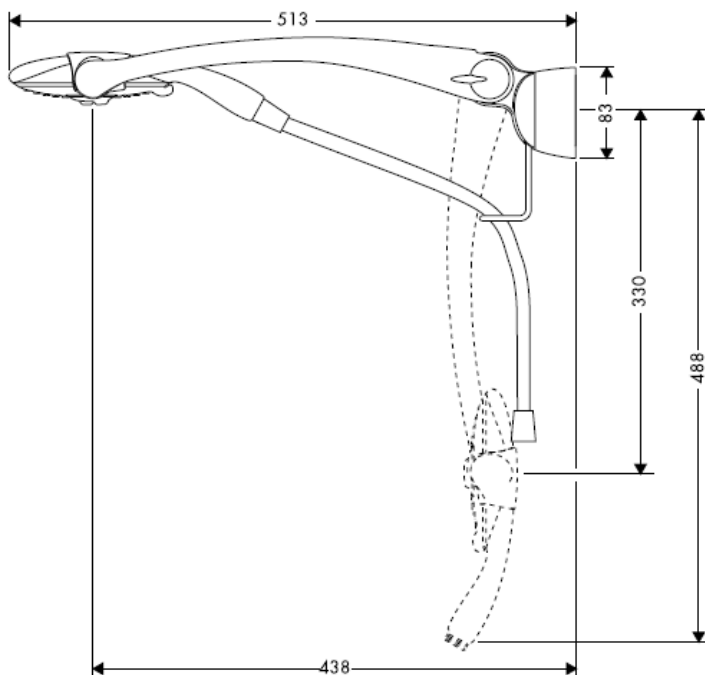

Raindance Eckmontage Set

28105000



Raindance UP-Adapter für Schlauchanschluß

28108000



Raindance Allrounder Set

28100000 / 28110000

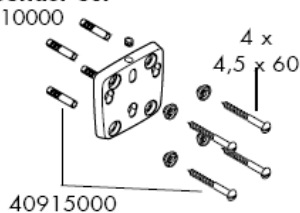

98562000

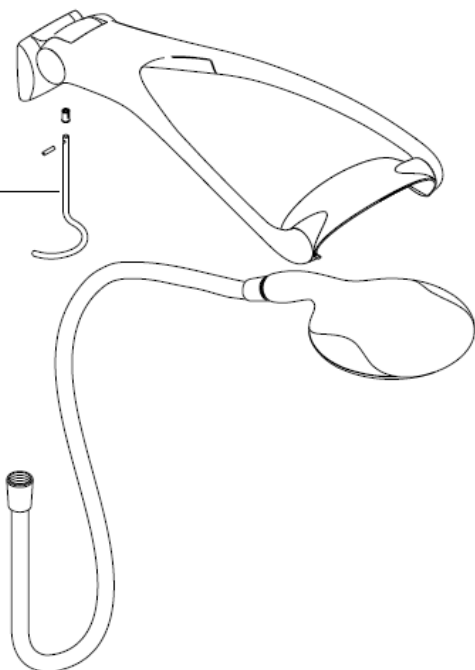

Raindance Eckmontage Set

28105000

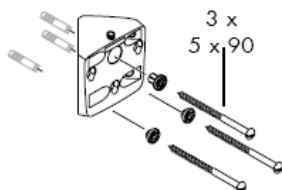

Raindance UP-Adapter für Schlauchanschluss

28108000

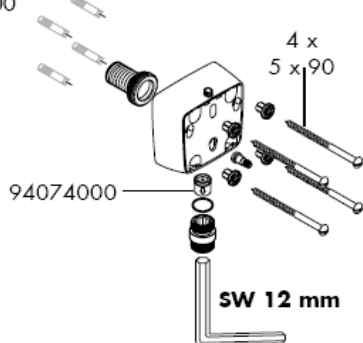

安装

为了防止管道中的脏东西冲入花洒内，与手持花洒包装在一起的滤柱(A)必须安装。如果想要更大的出水量，可用滤网(B)代替滤柱(A)。

这些脏东西会影响手持花洒的功能或损坏手持花洒的功能部件，由此引起的损失汉斯格雅公司概不负责。

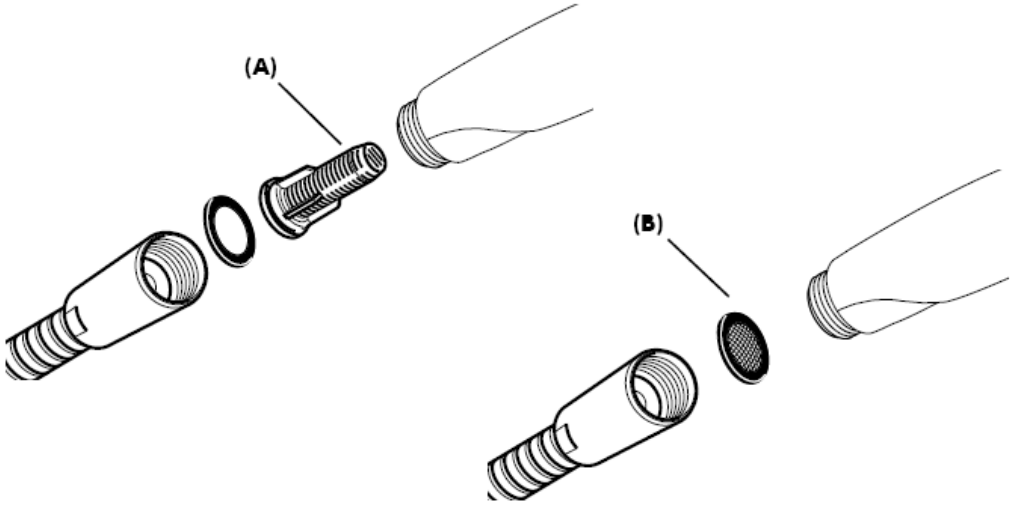

带滤柱 (A)

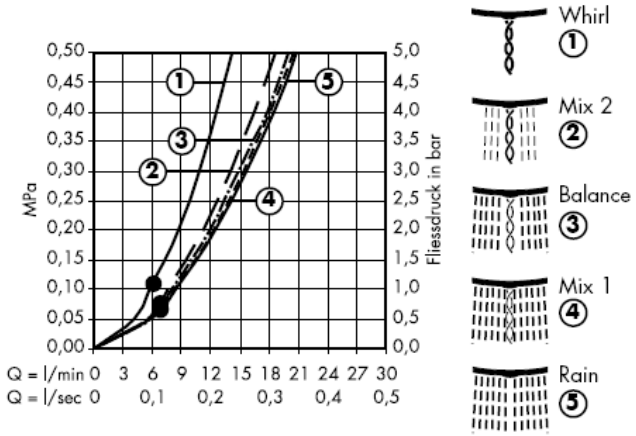

带滤网 (B)

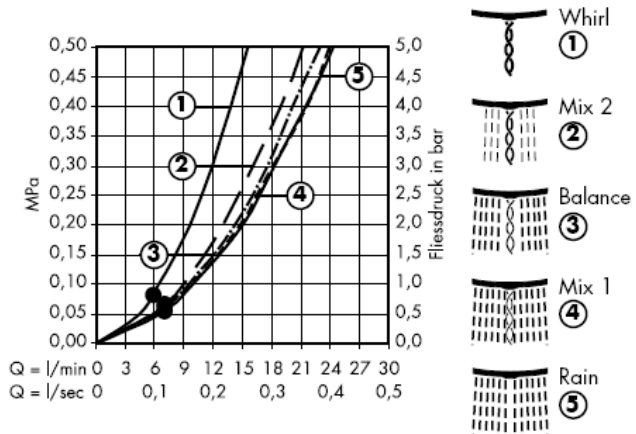

从•开始，正常功能得以保证。

带滤柱 (A)

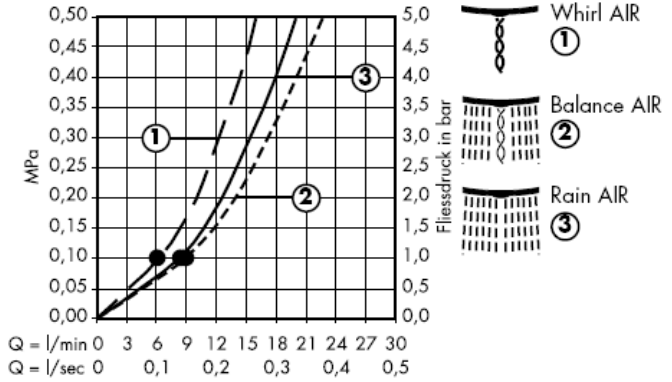

带滤网 (B)

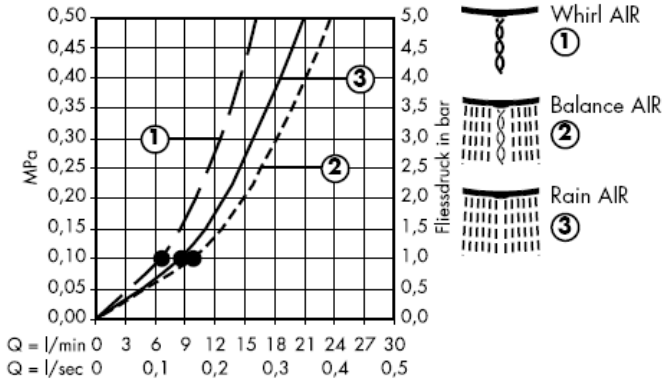

从•开始，正常功能得以保证。

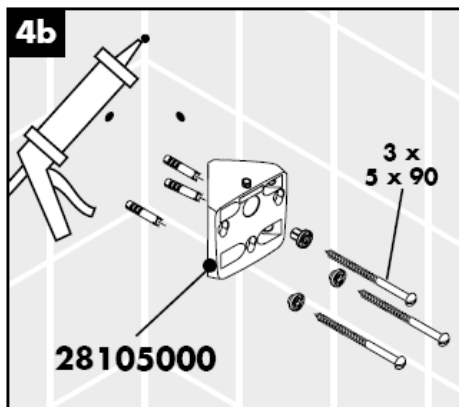
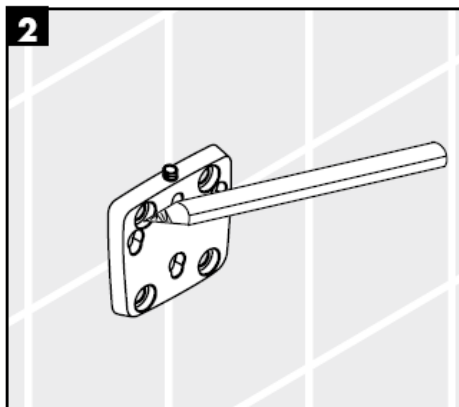
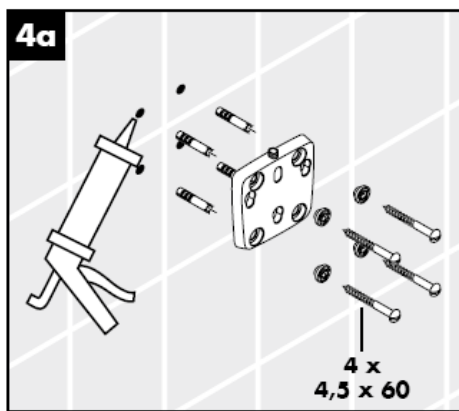
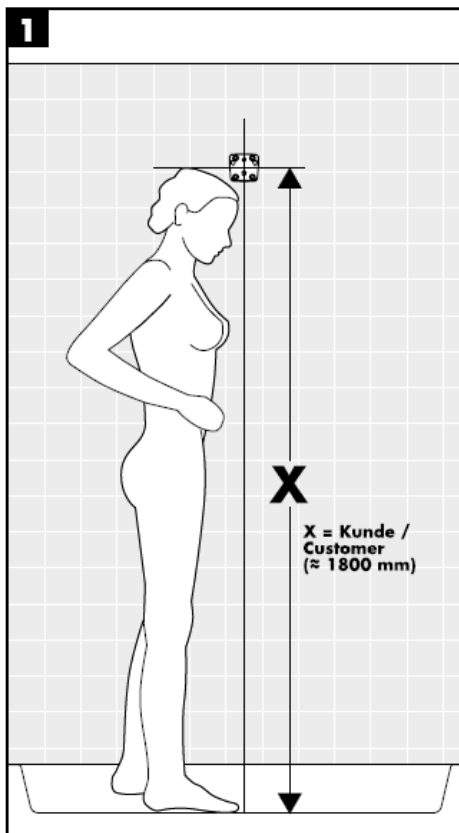

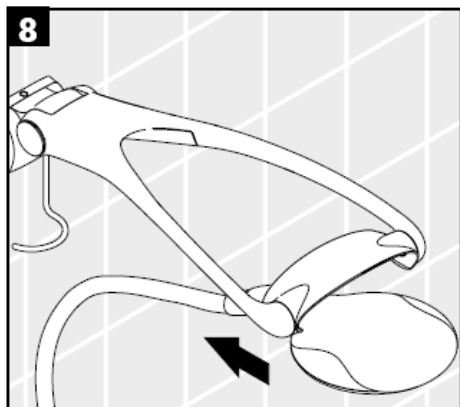
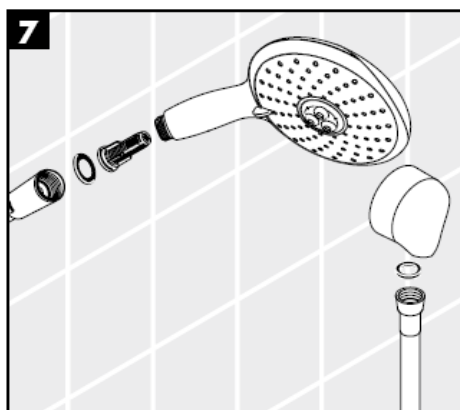
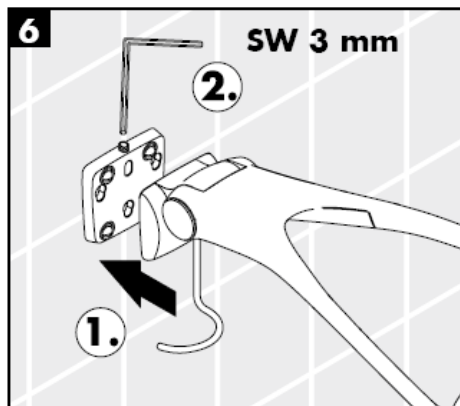

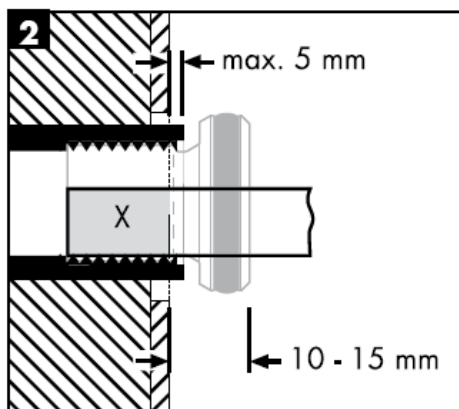
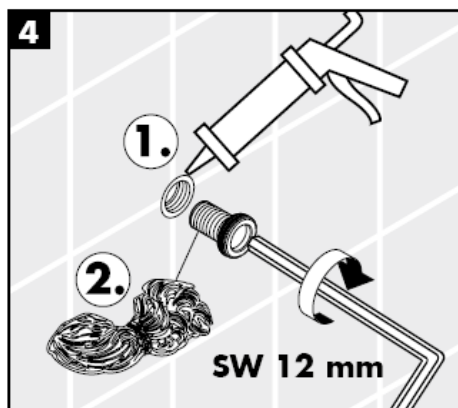
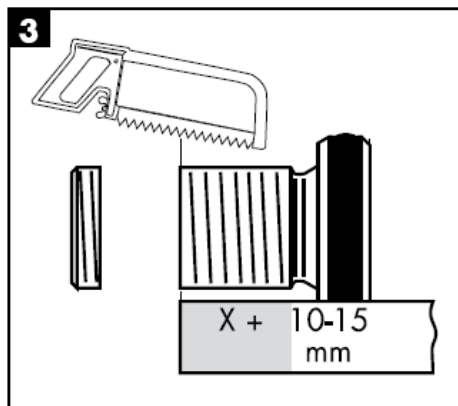
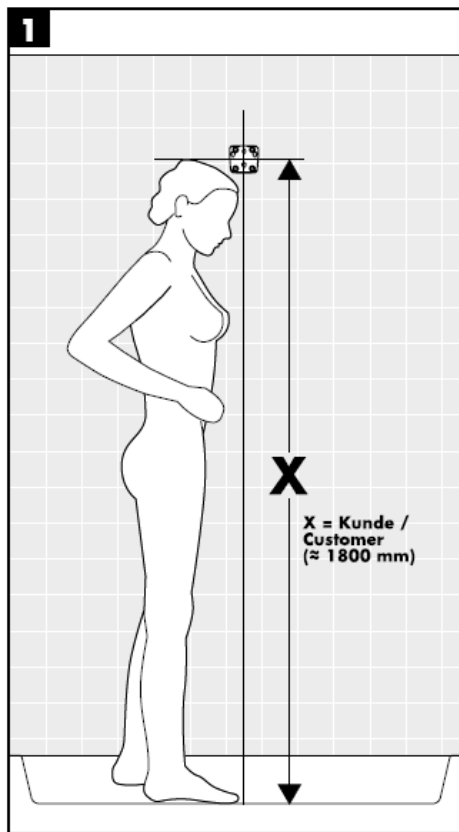

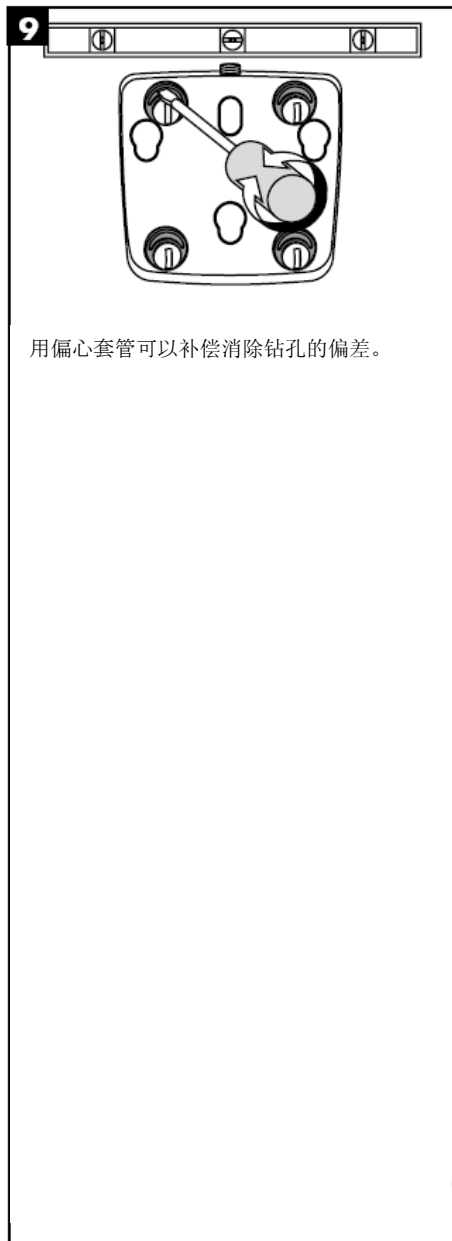
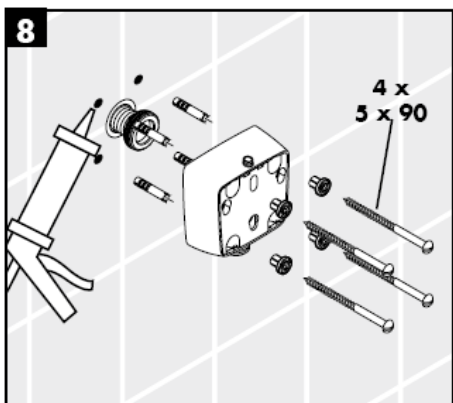
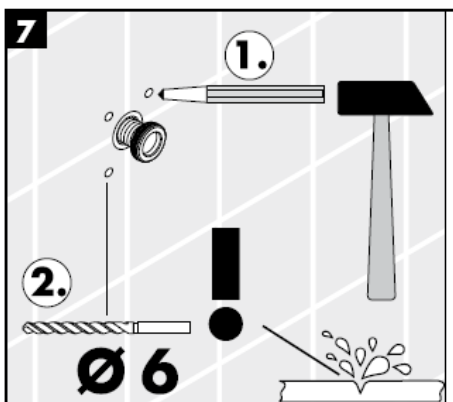
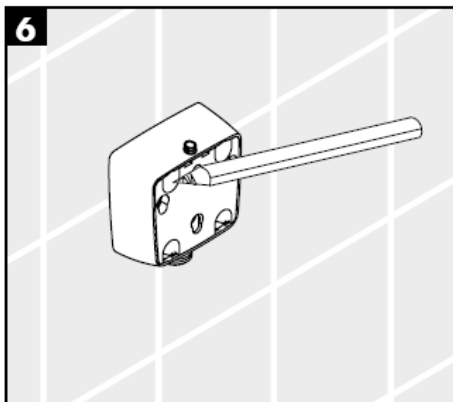

用偏心套管可以补偿消除钻孔的偏差。





Allrounder装置是一个多功能淋浴器系统。根据控制杆的位置，可以使用顶置、淋浴柱或单独的手提花洒。

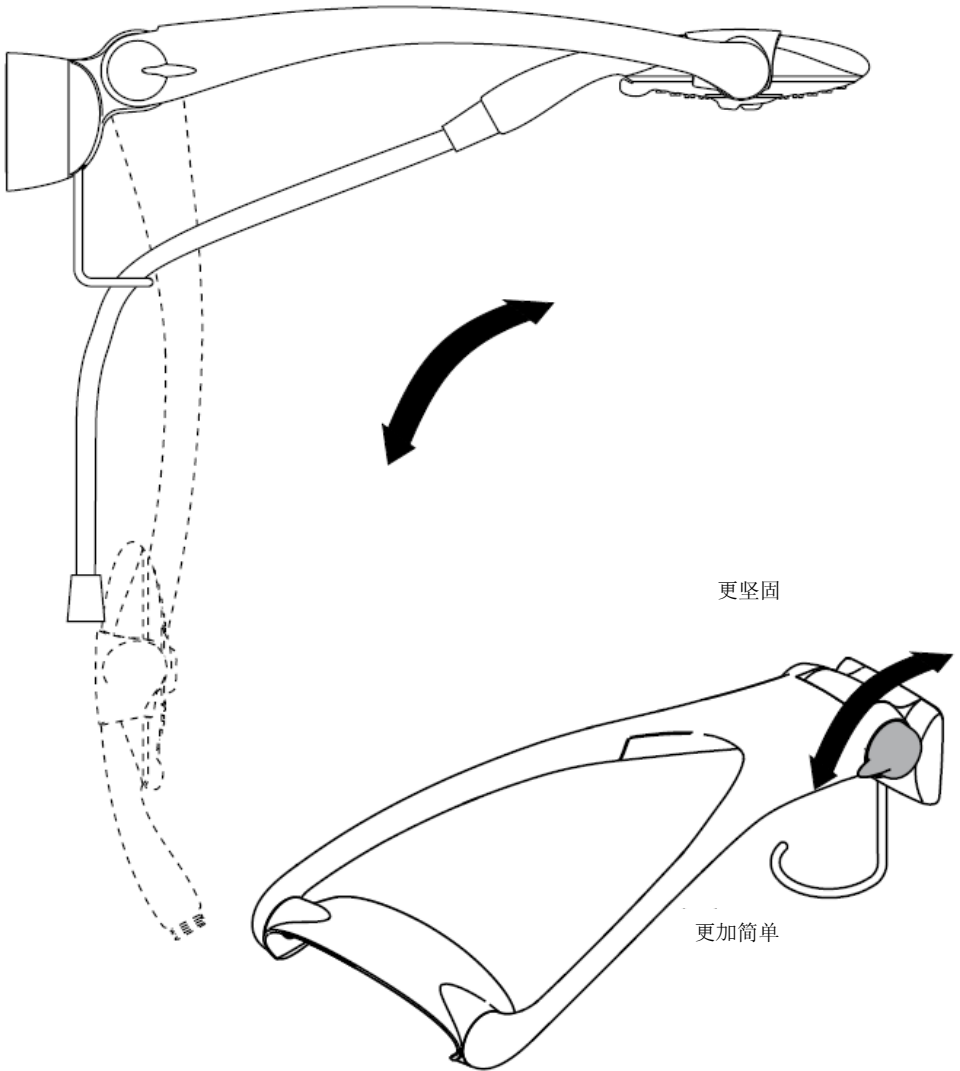

清洗

有了Rubit®, 手工清洁功能, 要去掉喷头上的水垢, 只需简单地搓除即可。

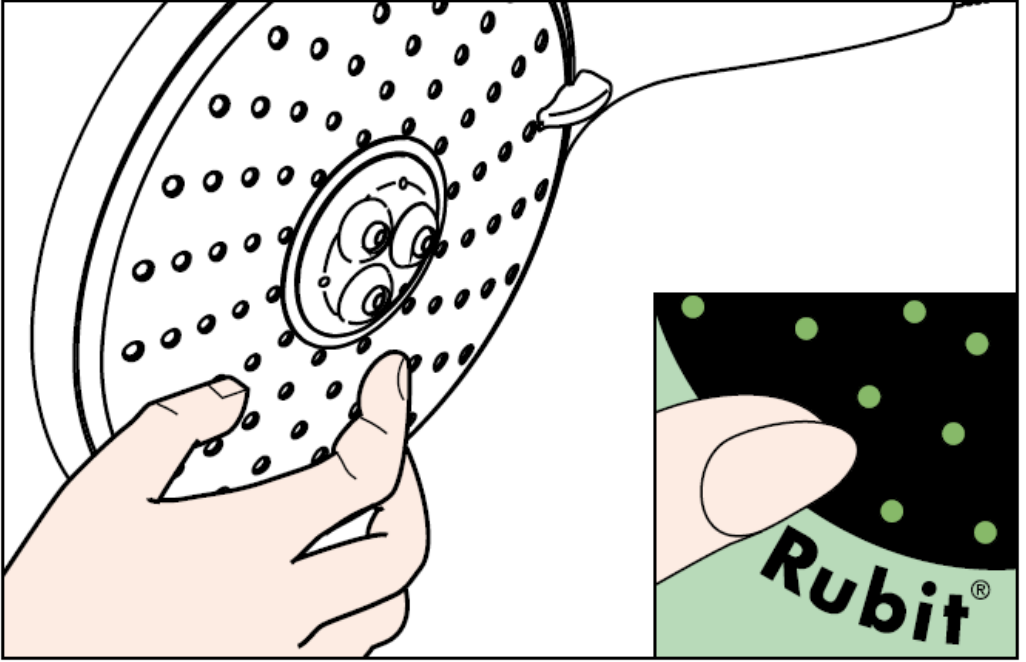

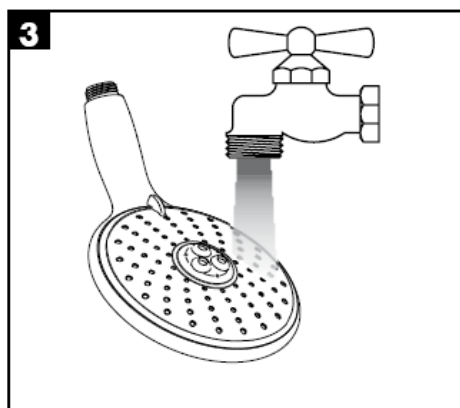
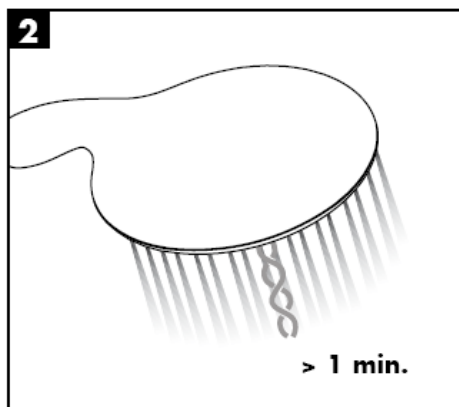
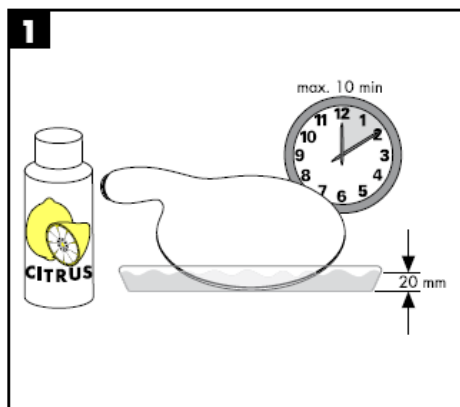

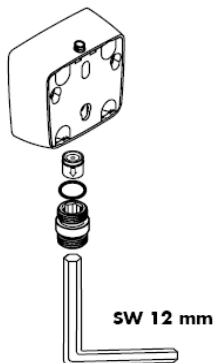

注意！

每年必须按照DIN

1988对单向阀的功能进行一次检查。

hansgrohe

Hansgrohe · Postfach 1145 · D-77761 Schiltach · Telefon +49 (0) 78 36/51-1282 · Telefax +49 (0) 7836/511440
E-Mail: info@hansgrohe.com · Internet: www.hansgrohe.com

02/2008
9.06081.04
中文

Инструкция по монтажу

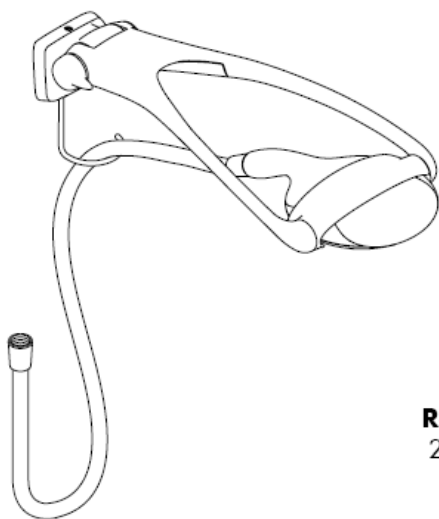

Raindance
28105000

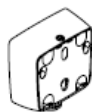

Raindance
28108000

Raindance Allrounder Set
28100000 / 28110000

hansgrohe

Raindance Allrounder Set

28100000 / 28110000

Classification acoustique et débit 28110000: ACS

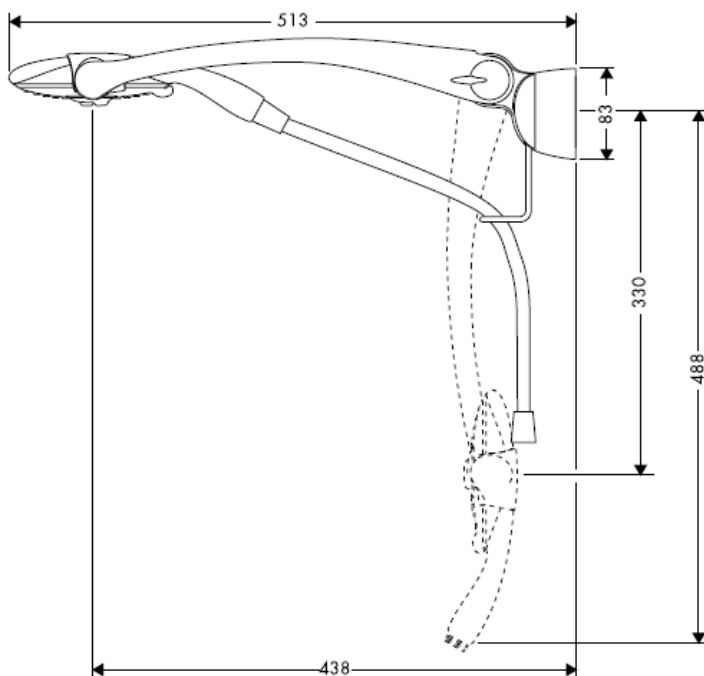

Raindance Eckmontage Set

28105000



Raindance UP-Adapter für Schlauchanschluß

28108000



Raindance Allrounder Set

28100000 / 28110000

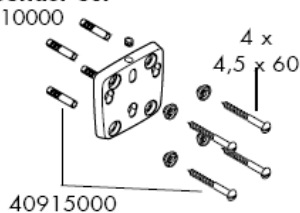

98562000

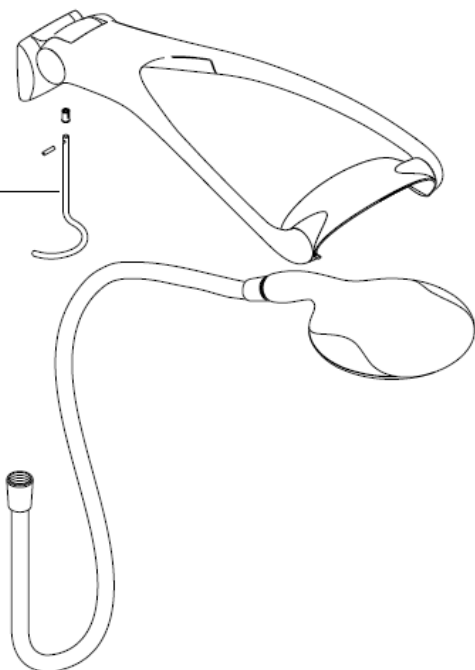

Raindance Eckmontage Set

28105000

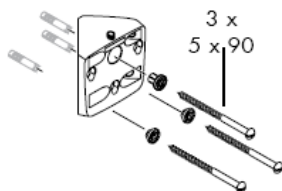

Raindance UP-Adapter für Schlauchanschluss

28108000

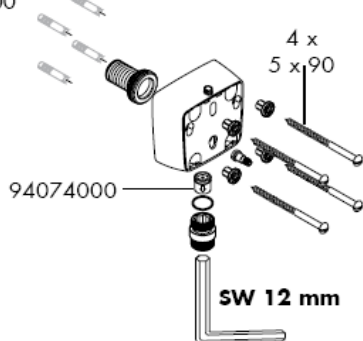

Монтаж

Предустановленный фильтр (А) предназначен для обеспечения стандартного расхода воды и защиты внутренней части лейки ручного душа от содержащихся в водопроводной воде загрязнений. Если Вы желаете повысить расход воды, Вам необходимо заменить предустановленный фильтр (А) на фильтр-сеточку (В).

Содержащиеся в воде загрязнения могут попав внутрь лейки привести к повреждениям/поломке внутреннего механизма лейки.

В этом случае покупатель теряет право на гарантию.

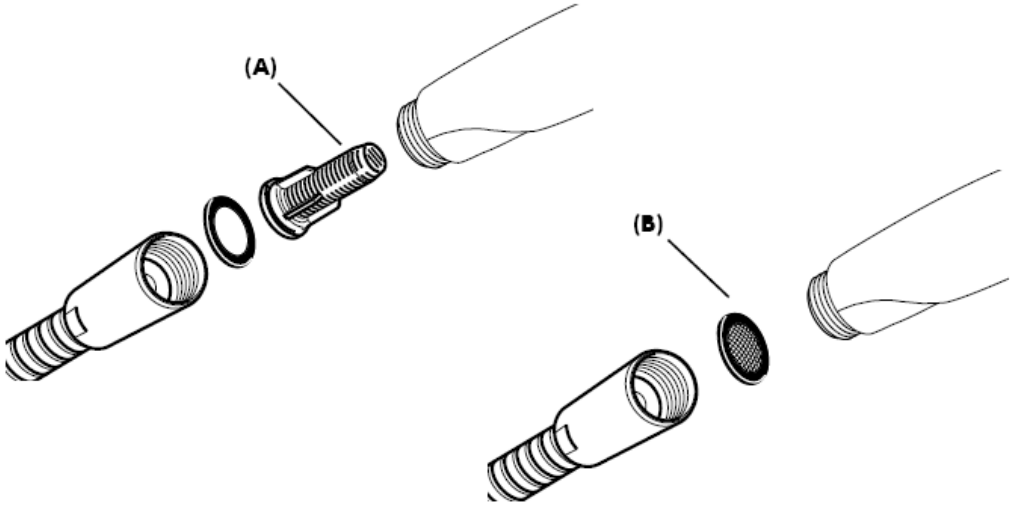

281000000

С фильтрующей вставкой
(А)

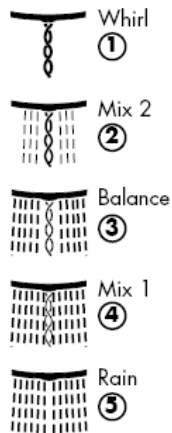
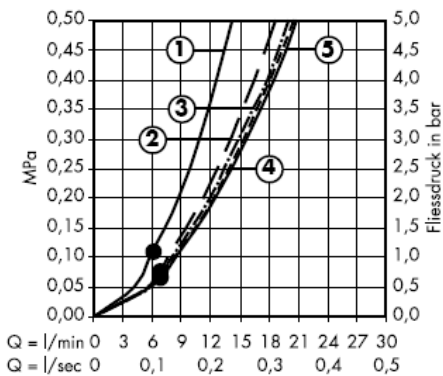

С фильтром-сеткой,
содержится в упаковке.

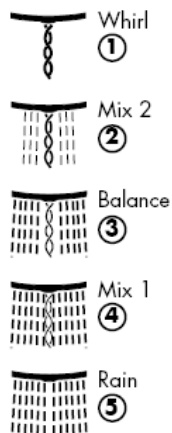
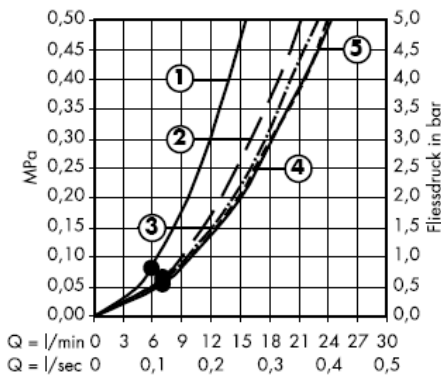

Гарантированное функционирование при показателях свыше •.

С фильтрующей вставкой (A)

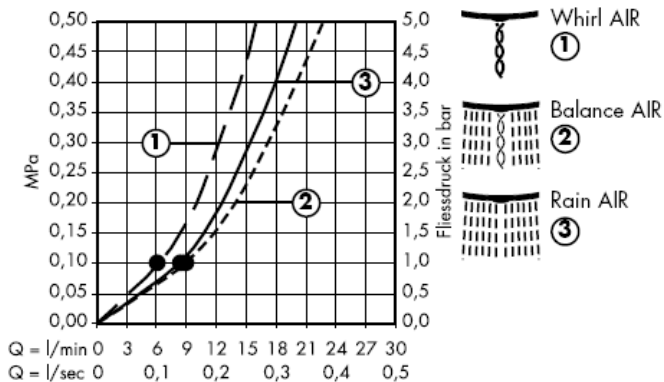

С фильтром-сеткой, содержится в упаковке.

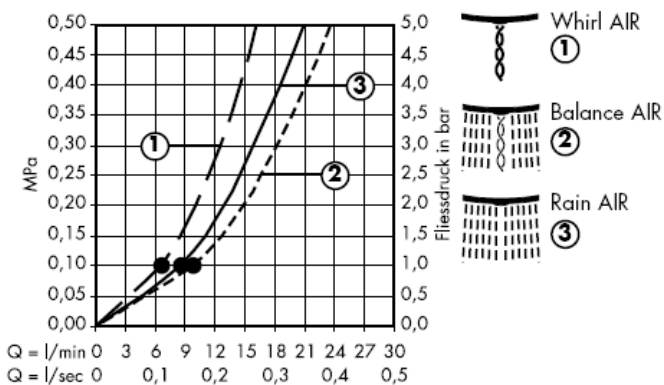

Гарантированное функционирование при показателях свыше •.

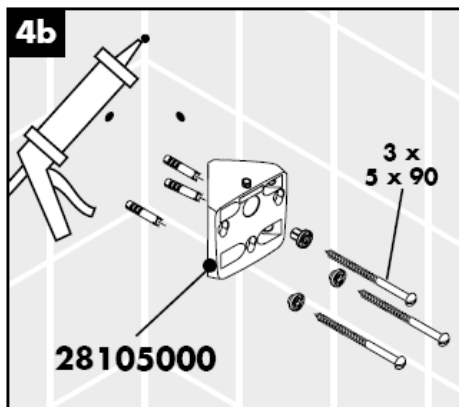
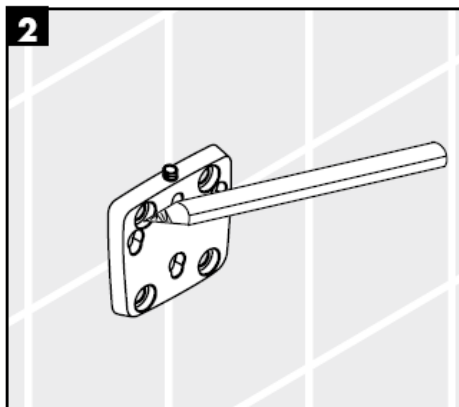

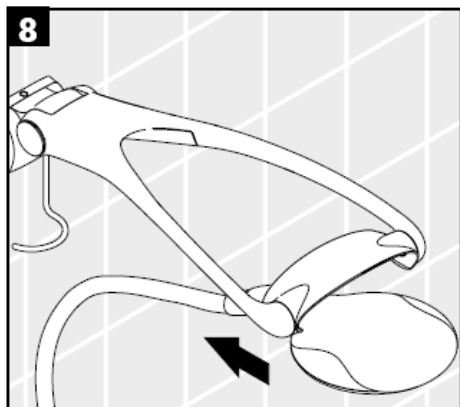
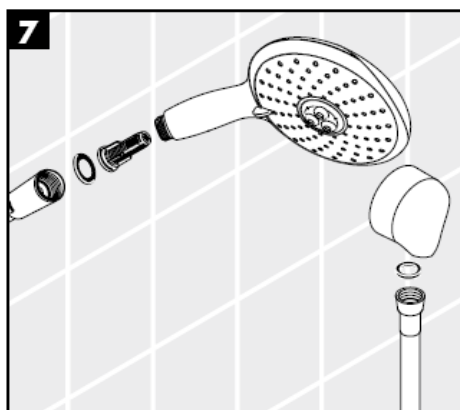
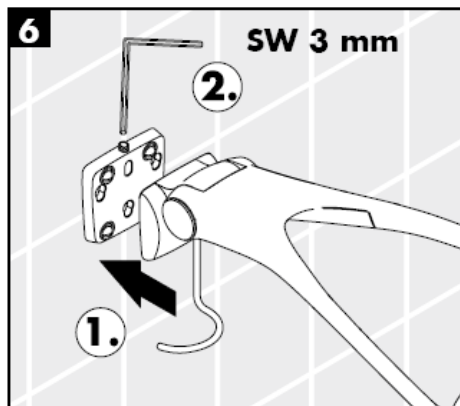
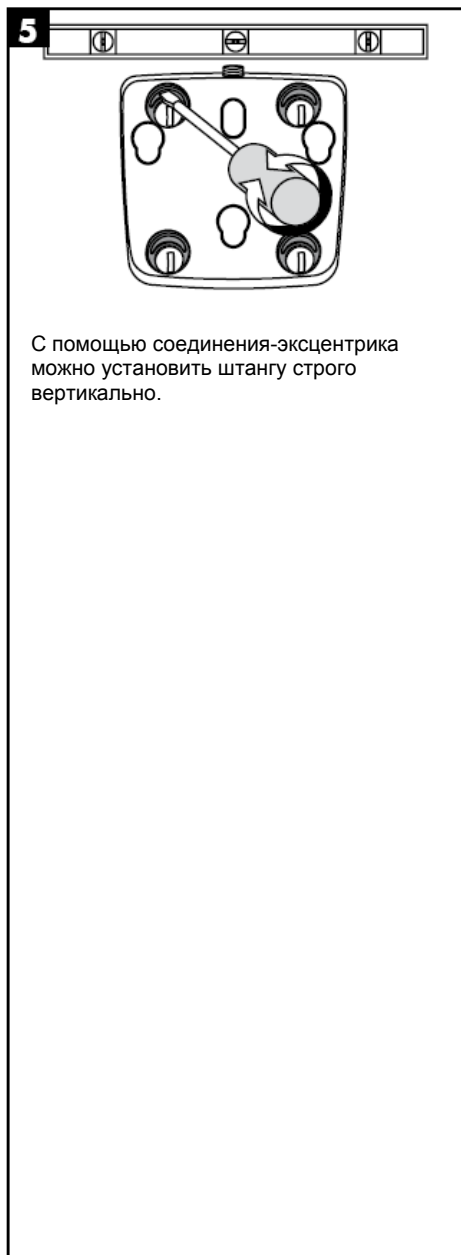

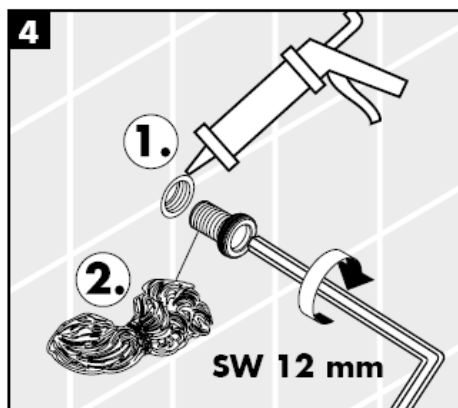
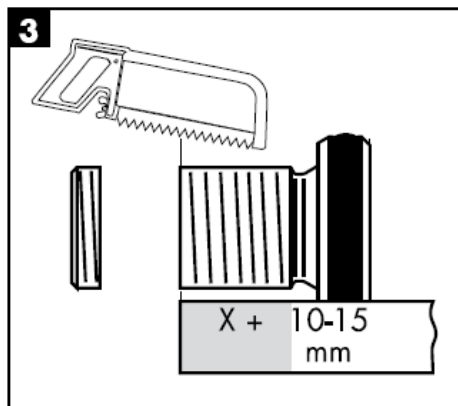
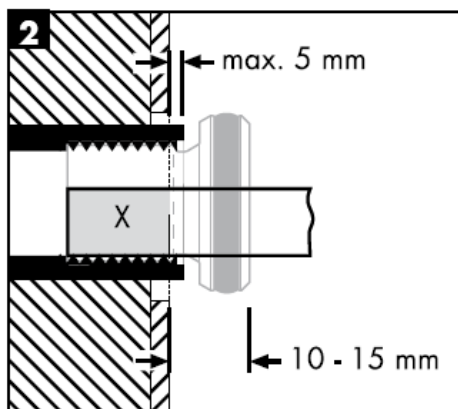
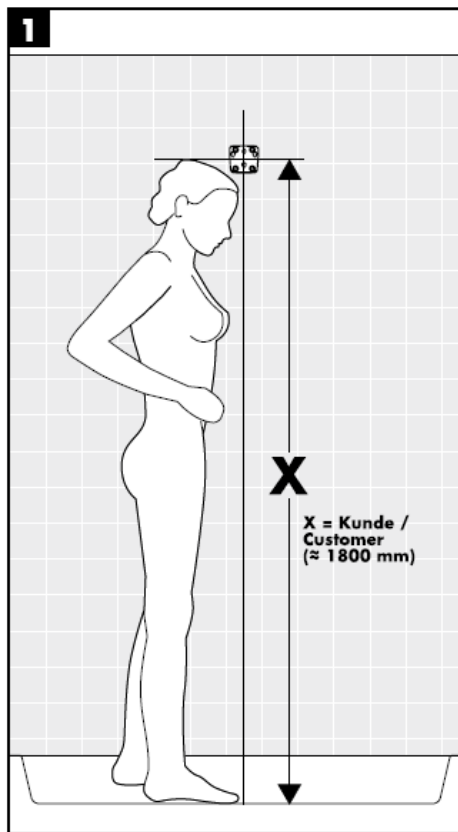

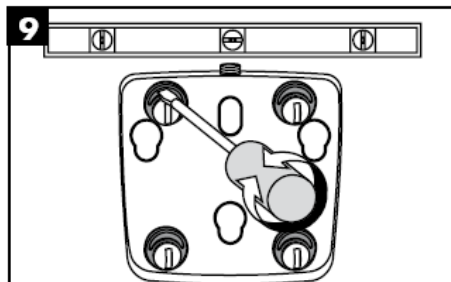
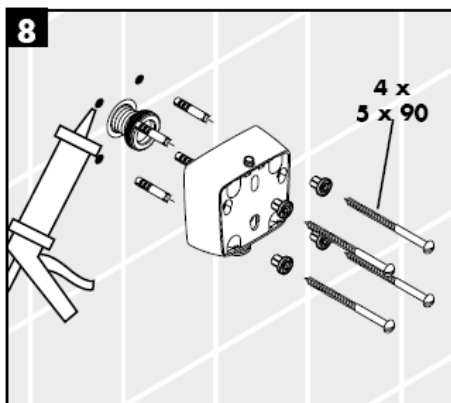
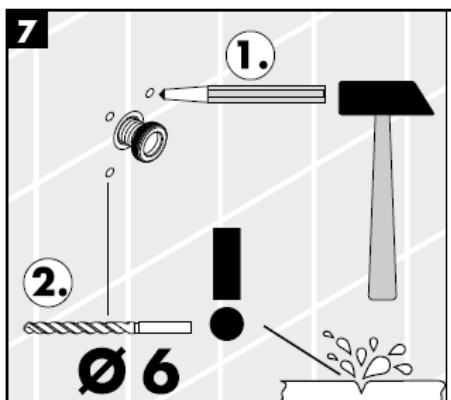
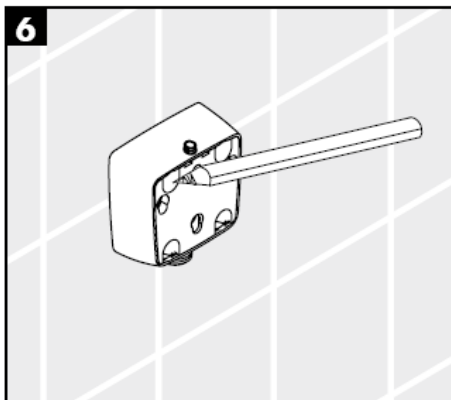

С помощью соединения-эксцентрика можно установить штангу строго вертикально.





Комплект Allrounder представляет собой многофункциональную душевую систему. В зависимости от положения скобы возможно использование верхнего или бокового душа и отдельного ручного душа.

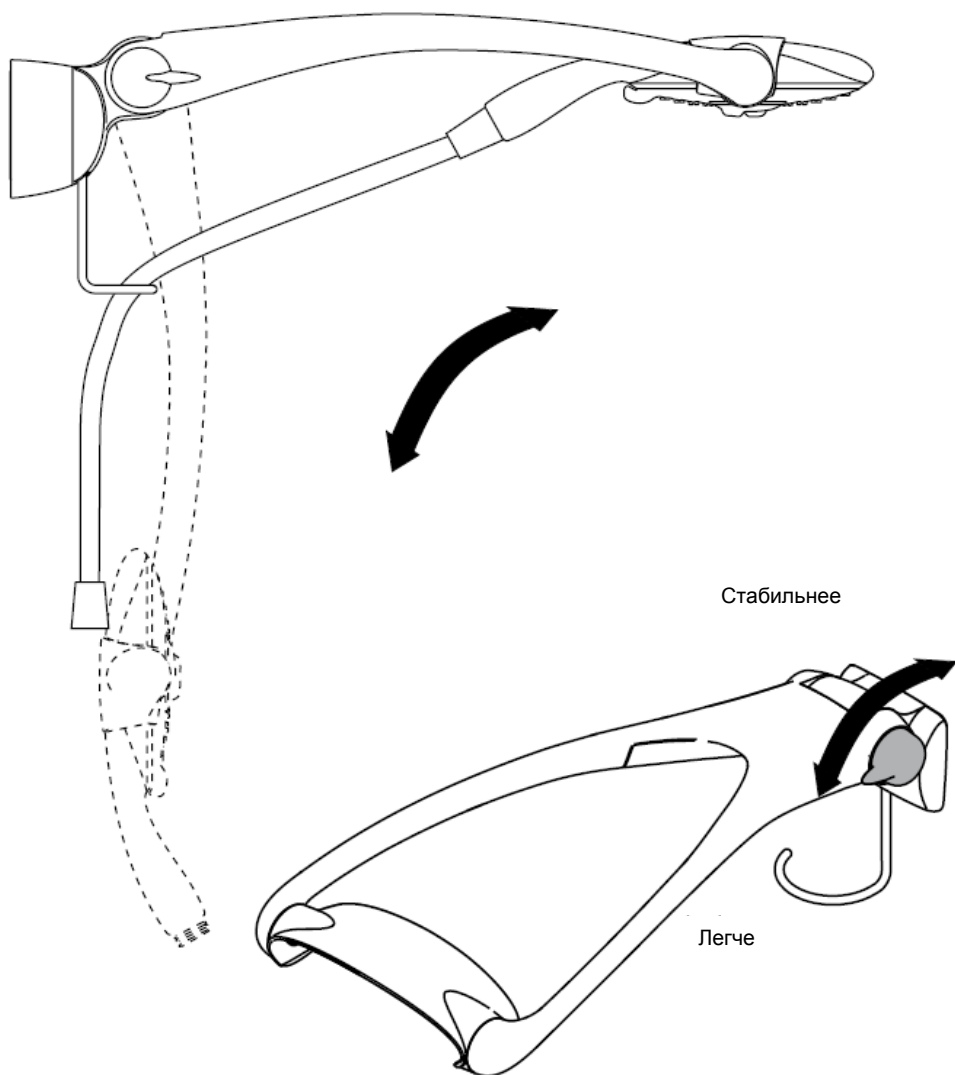

система Rubit® позволяет удалять известковые отложения, достаточно провести по эластичной поверхности аэратора пальцем, как известковые отложения будут удалены.

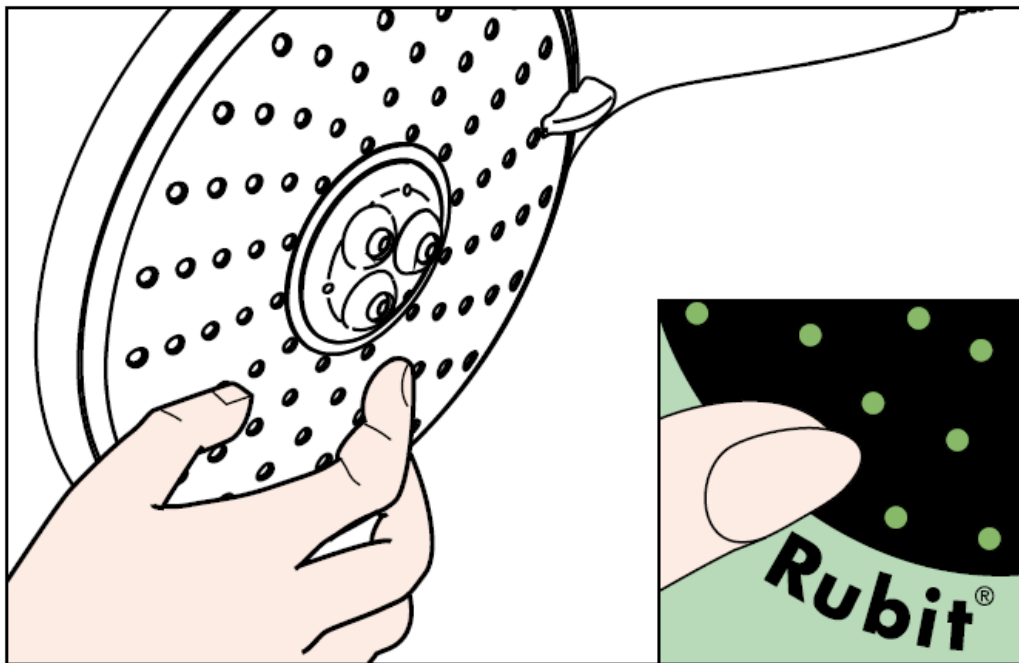

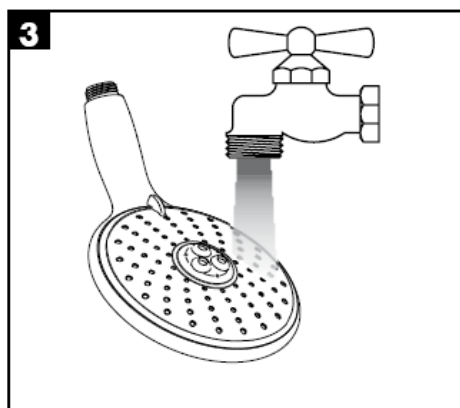
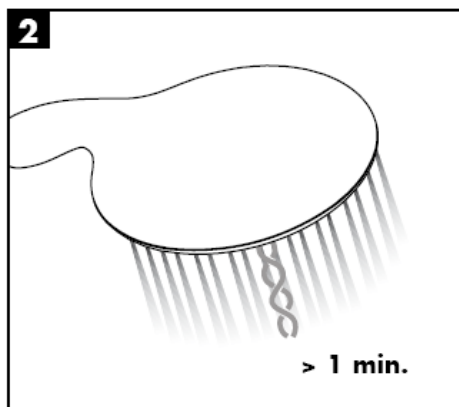
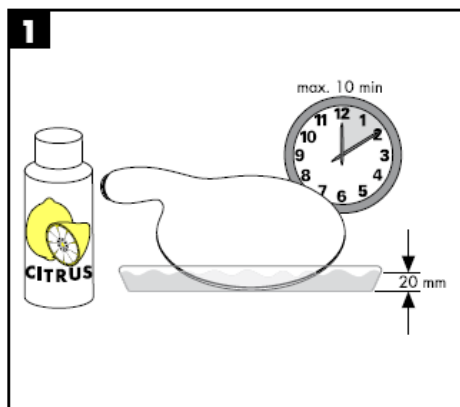

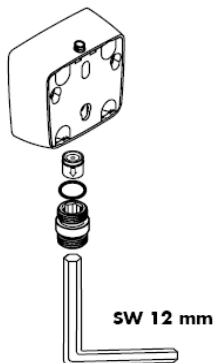

Осторожно!

клапан обратного тока воды должен
проверяться не реже одного раза в год

hansgrohe

Hansgrohe · Postfach 1145 · D-77761 Schiltach · Telefon +49 (0) 78 36/51-1282 · Telefax +49 (0) 7836/511440
E-Mail: info@hansgrohe.com · Internet: www.hansgrohe.com

02/2008
9.06081.04
Русский

Szerelési útmutató

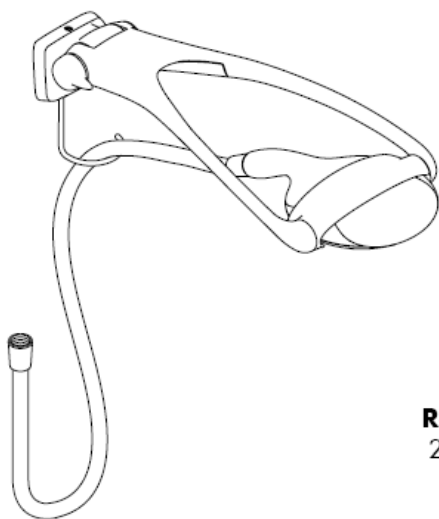

Raindance
28105000

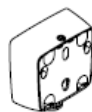

Raindance
28108000

Raindance Allrounder Set
28100000 / 28110000

hansgrohe

Raindance Allrounder Set

28100000 / 28110000

Classification acoustique et débit 28110000: ACS

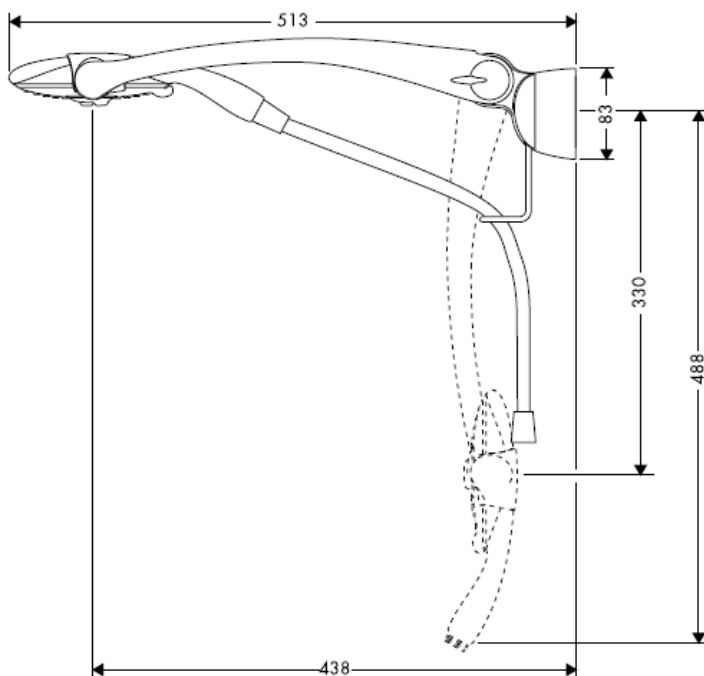

Raindance Eckmontage Set

28105000



Raindance UP-Adapter für Schlauchanschluß

28108000



Raindance Allrounder Set

28100000 / 28110000

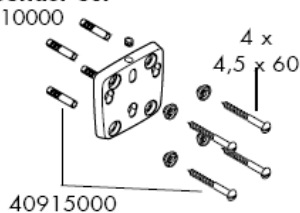

98562000

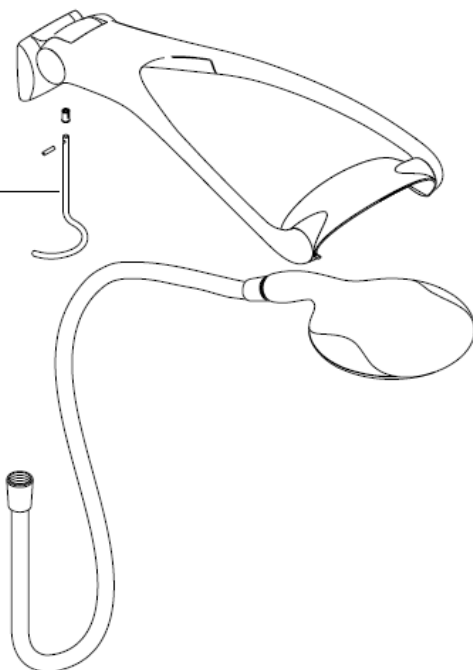

Raindance Eckmontage Set

28105000

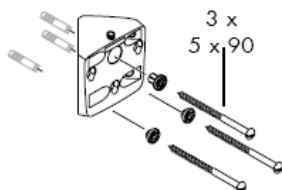

Raindance UP-Adapter für Schlauchanschluss

28108000

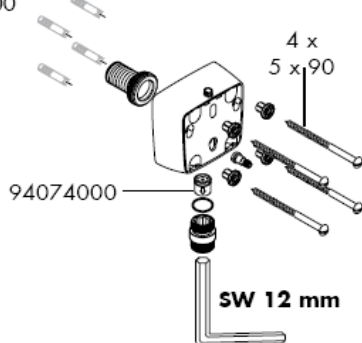

Szerelés

A mellékelt szűrőbetétet (A) be kell szerelni, hogy elérjük a kézizuhany norma szerinti átfolyását, valamint, hogy elkerüljük a vezetékes hálózathoz tartozó szennyeződések zuhanyba való bekerülését. Amennyiben nagyobb átfolyási vízmennyiséget szeretnénk elérni, a szűrőbetét (A) helyett használjuk a szűrőtömítést (B). A vezetékes hálózathoz tartozó szennyeződések gátolhatják a termék működését, és/vagy megrongálhatják a zuhany működő alkatrészeit. Az ebből adódó károkért a Hansgrohe nem felel.

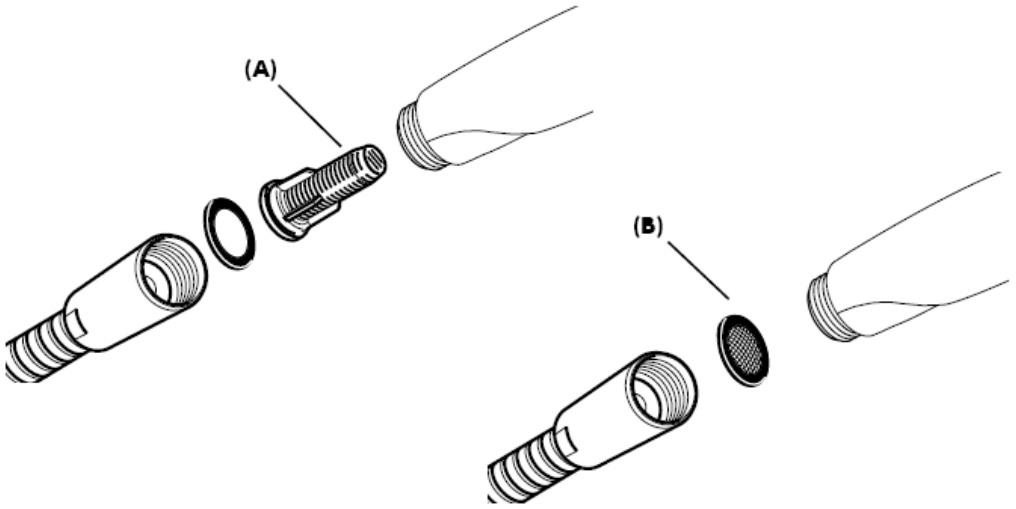

Szűrőbetéttel (A)

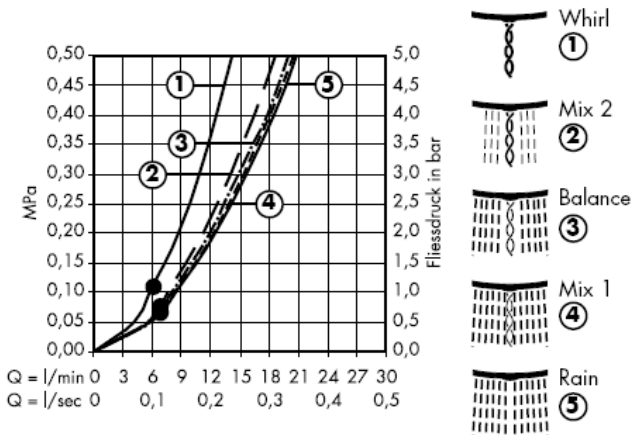

Szűrőtömítéssel (B)

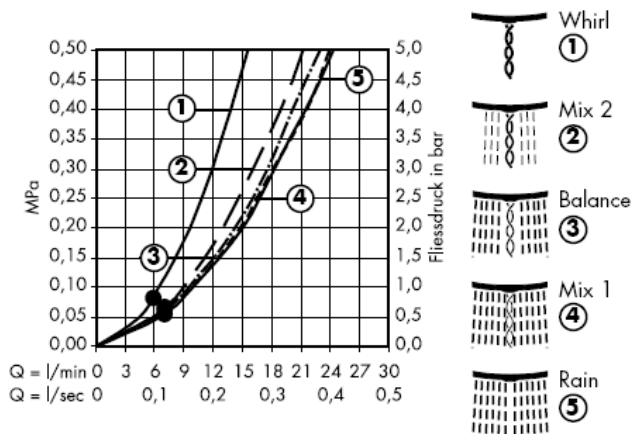

A • -től működik az adott funkció.

Szűrőbetéttel (A)

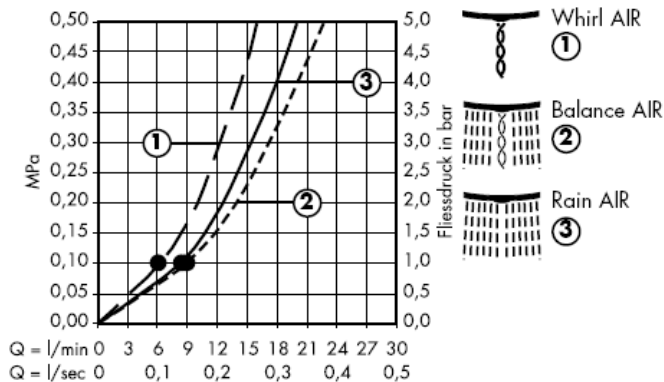

Szűrőtömítéssel (B)

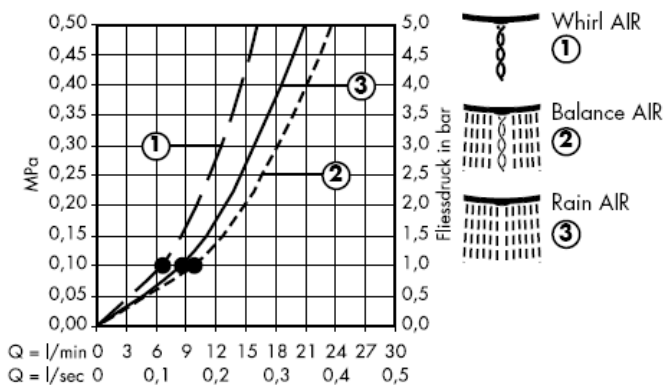

A • -től működik az adott funkció.

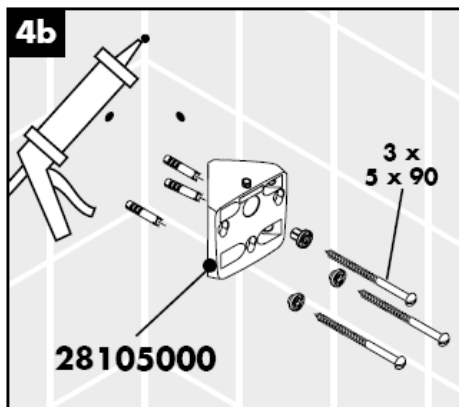
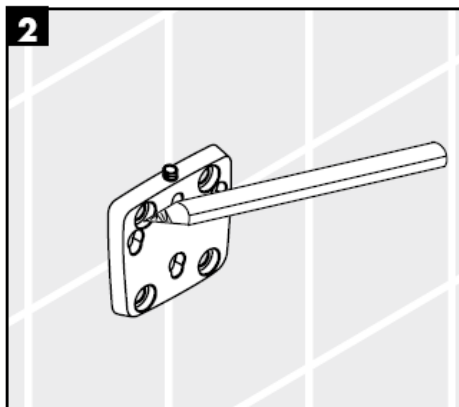

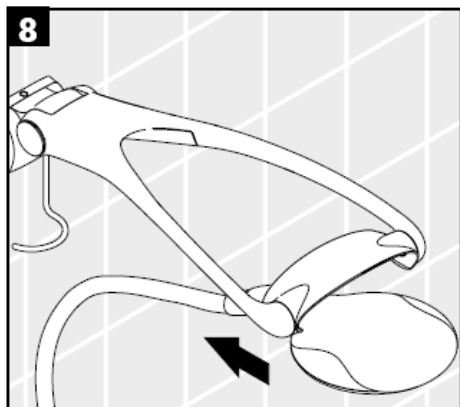
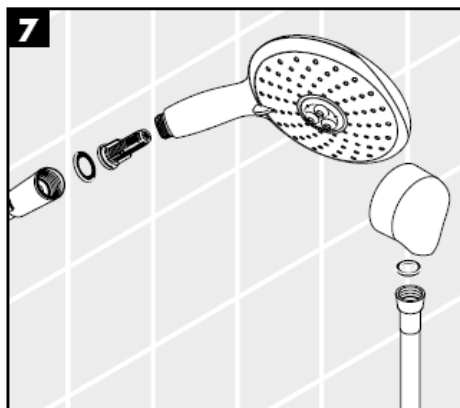
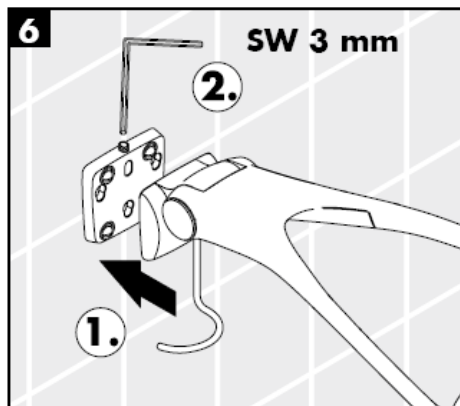
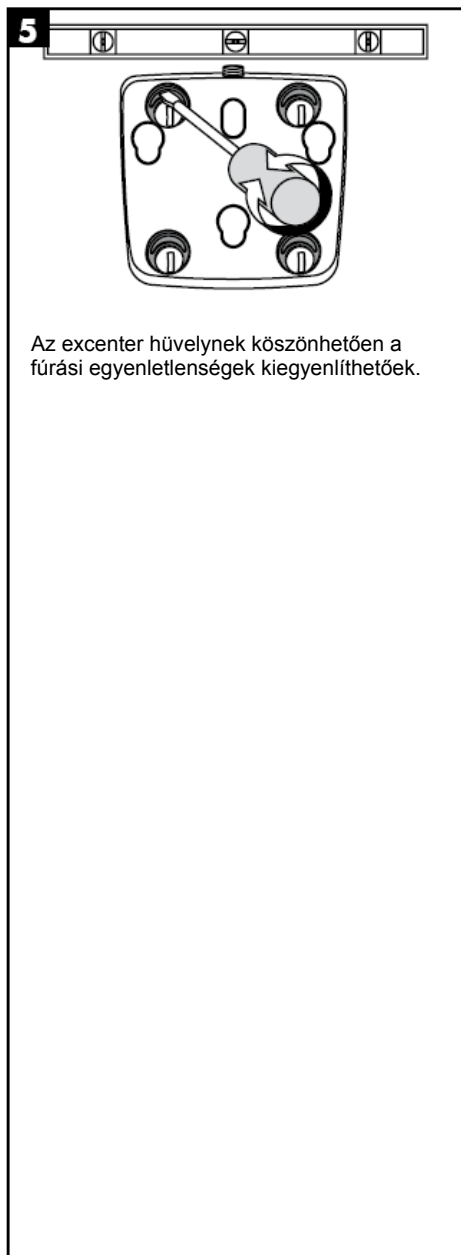

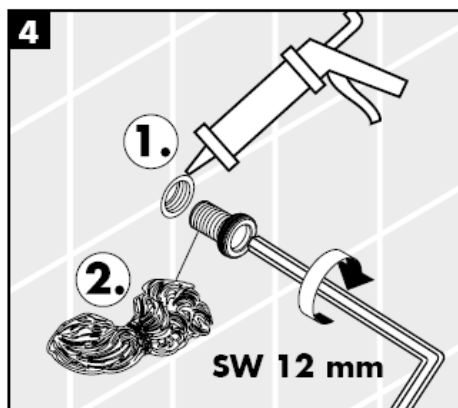
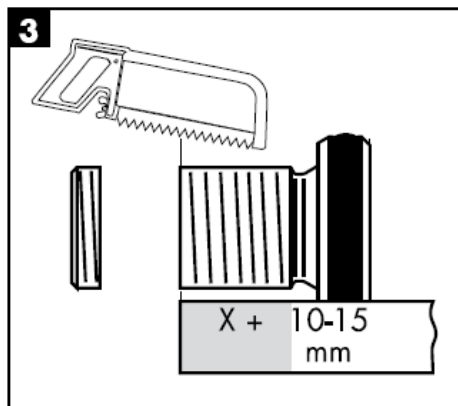
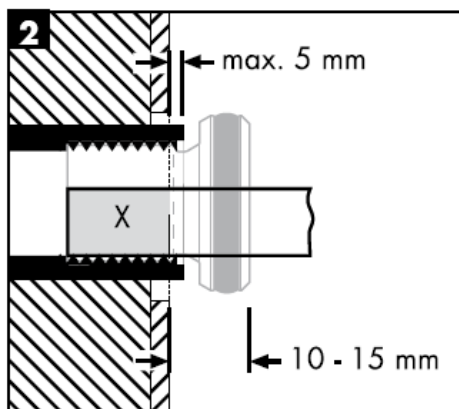
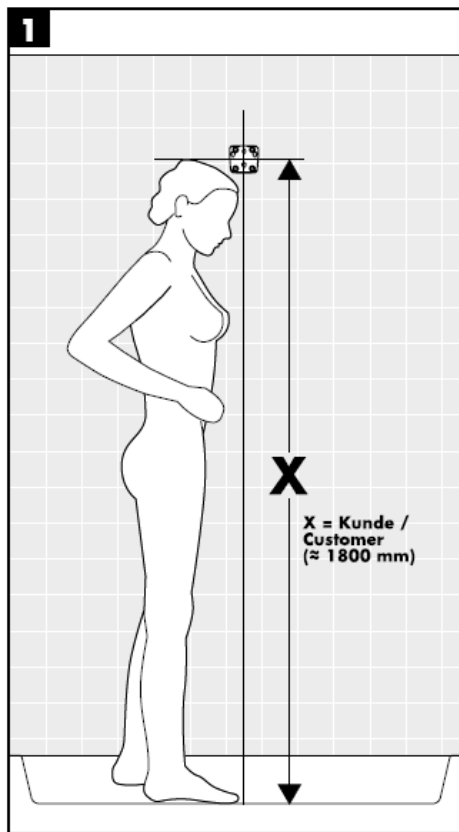

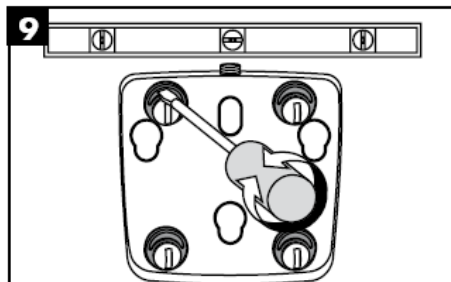
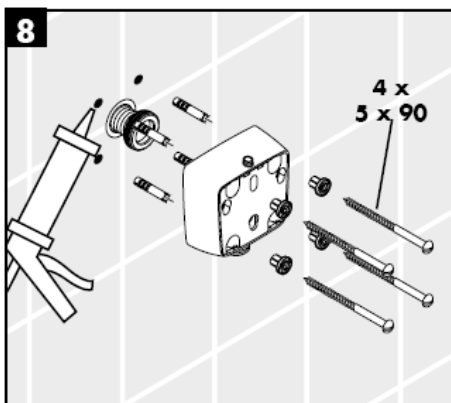
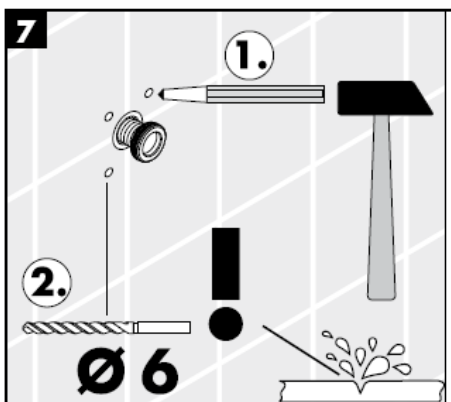
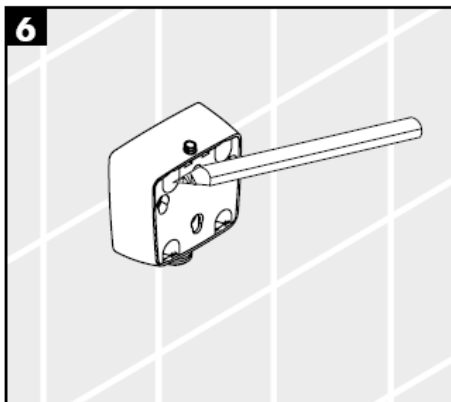

Az excenter hüvelynek köszönhetően a fúrási egyenetlenségek kiegyenlíthetők.





Az Allrounder készlet egy multifunkcionális zuhanyrendszer. A fogantyú állásától függően használhatók a fej- vagy oldalsó zuhanyfunkciók, ill. a külön kézi zuhany.

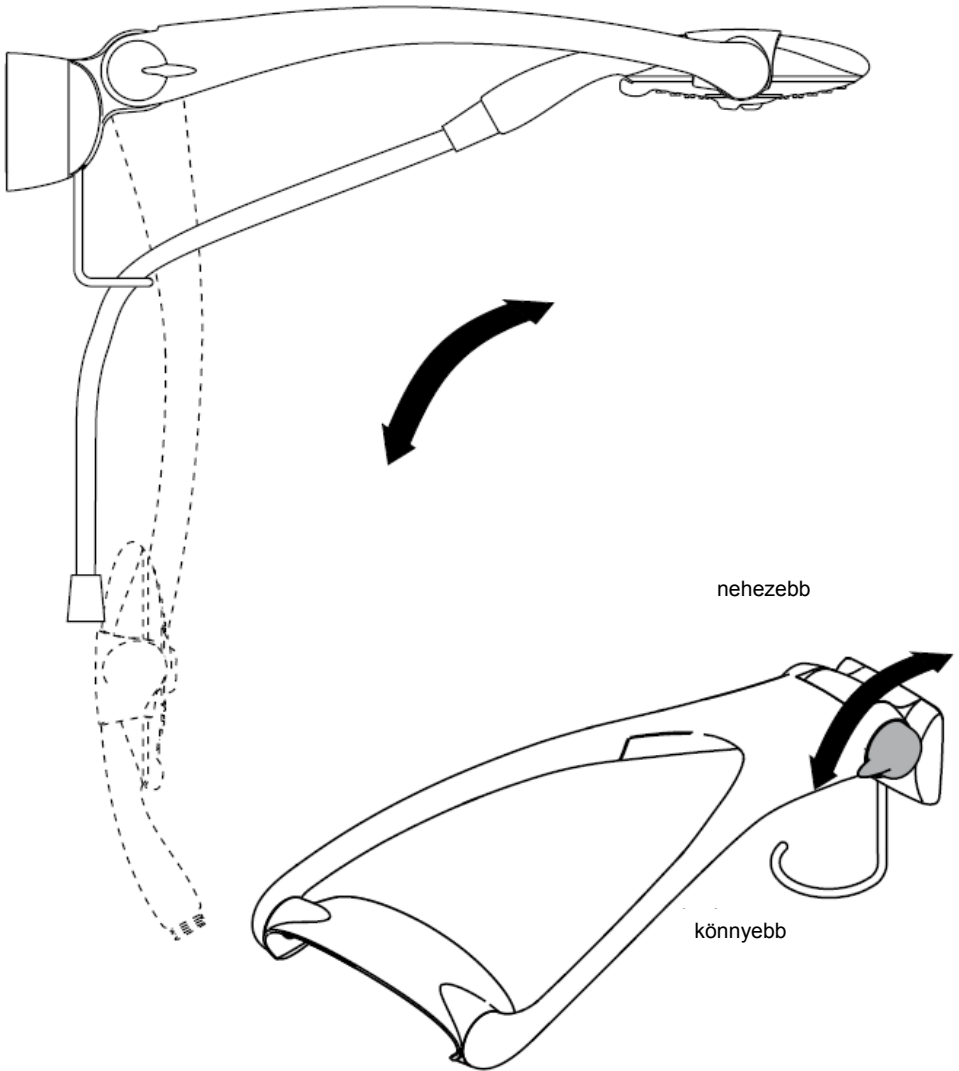

Tisztítás

A Rubit® manuális tisztítófunkciónak köszönhetően a vízsugárnyílások egyszerű ledörzsöléssel megtisztíthatóak a vízkőtől.

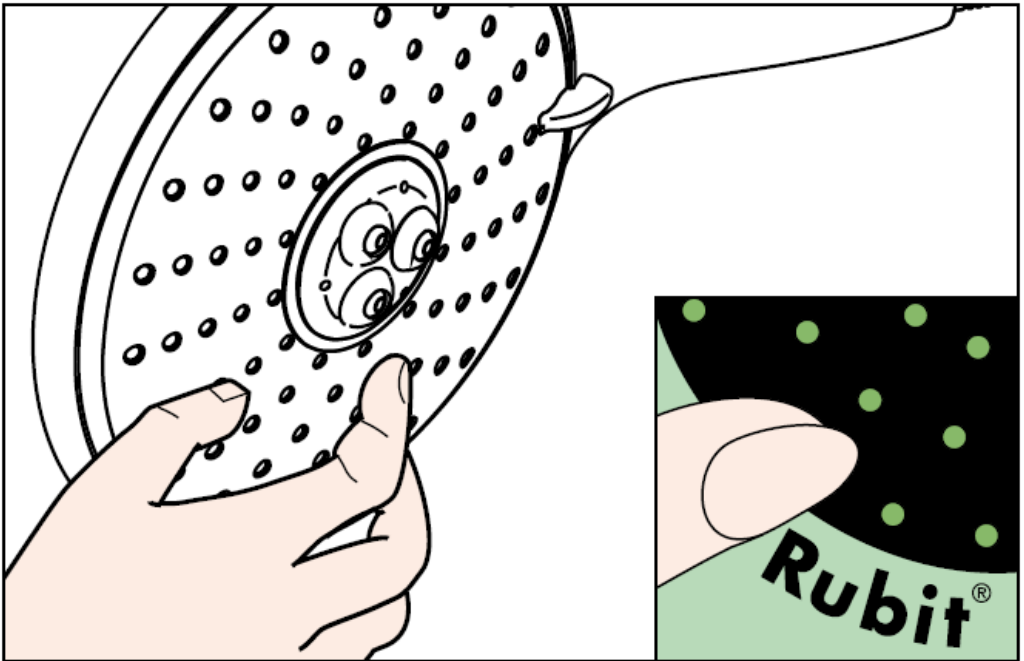

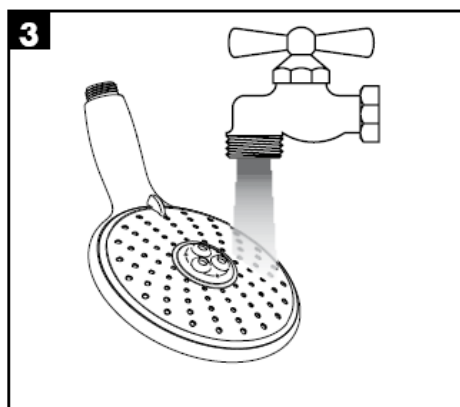
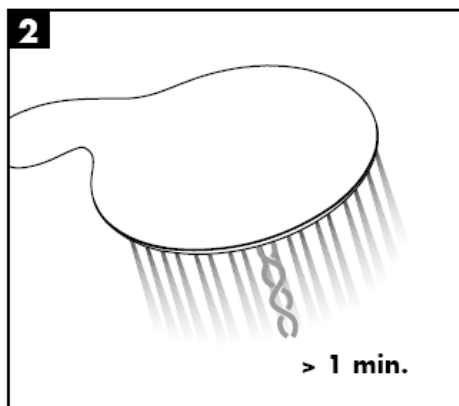
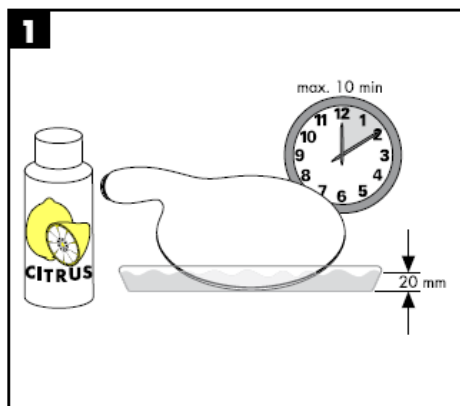

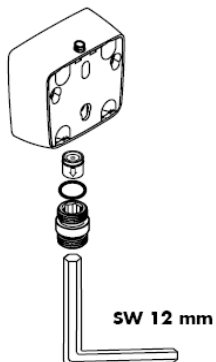

Figyelem!

A visszafolyásgátlók működését a DIN 1988 szerint évente egyszer ellenőrizni kell.

hansgrohe

Asennusohje

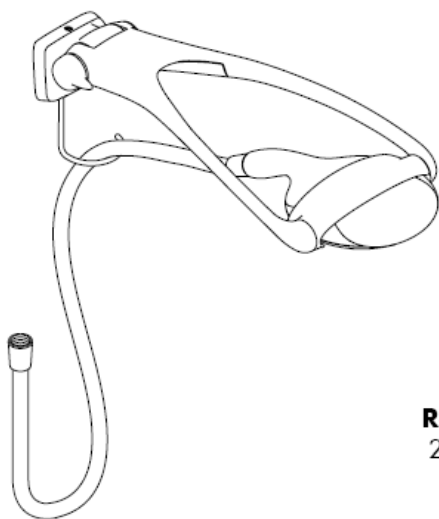

Raindance
28105000

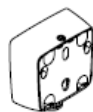

Raindance
28108000

Raindance Allrounder Set
28100000 / 28110000

hansgrohe

Raindance Allrounder Set

28100000 / 28110000

Classification acoustique et débit 28110000: ACS

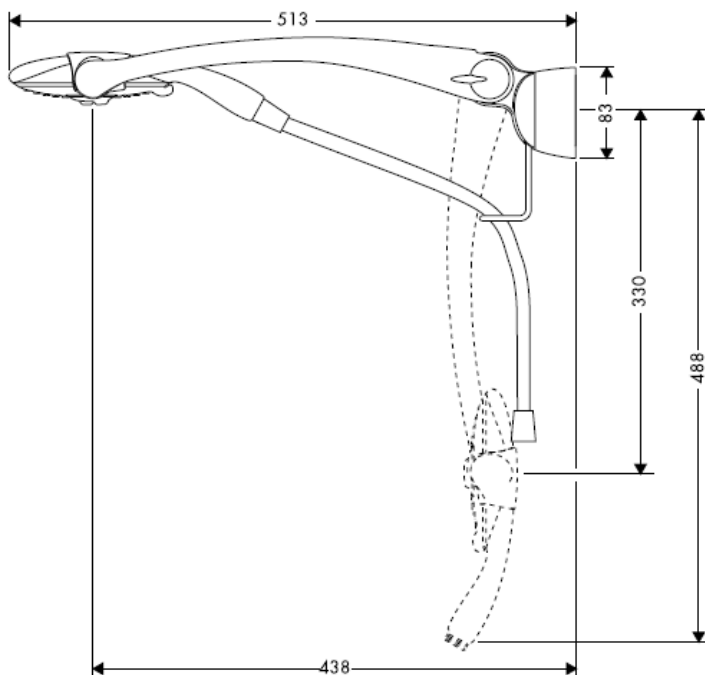

Raindance Eckmontage Set

28105000



Raindance UP-Adapter für Schlauchanschluß

28108000



Raindance Allrounder Set

28100000 / 28110000

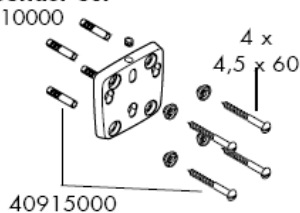

98562000

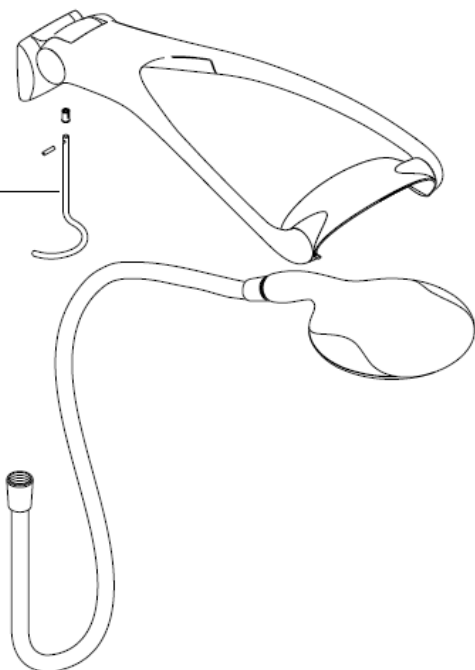

Raindance Eckmontage Set

28105000

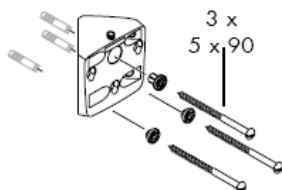

Raindance UP-Adapter für Schlauchanschluss

28108000

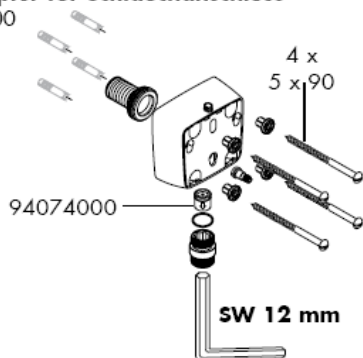

Asennus

Käsisuihkun mukana toimitettu suodatinpatruuna (A) on asennettava paikalleen, jotta käsisuihkun normaalivirtaus olisi taattuna ja, jotta lian huuhtoutuminen vesijohtoverkostosta käsisuihkuun estyy. Jos halutaan suurempaa vesimäärää, suodatinpatruunan (A) tilalle voidaan asentaa sihtitiiviste (B). Huuhtoutuvat likahiukkaset voivat häiritä suihkun toimintaa tai vahingoittaa toimintaosia, Hansgrohe ei vastaa tästä aiheutuneista vahingoista.

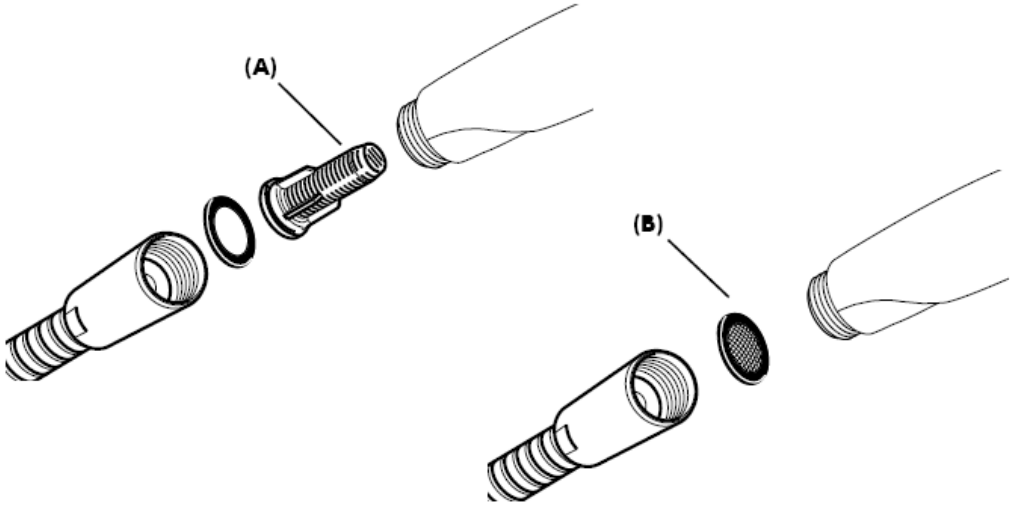

Suodatinpanoksella (A)

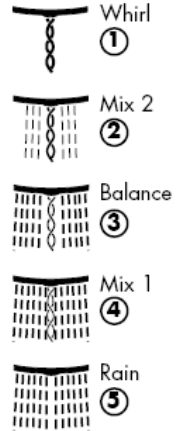
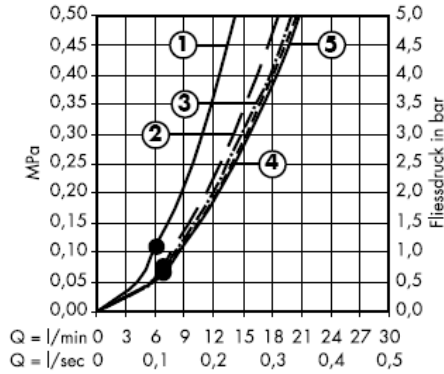

Sihtitiviesteellä (B)

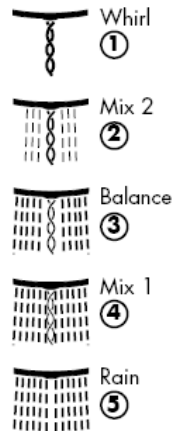
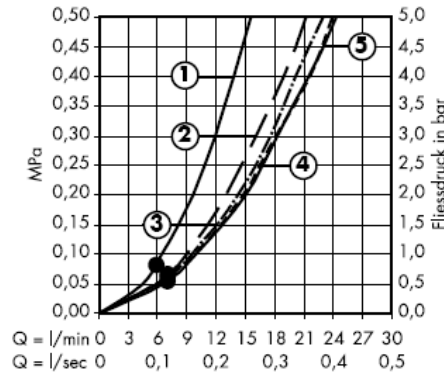

Tämä toiminta on taattuna • alkaen.

Suodatinpanoksella (A)

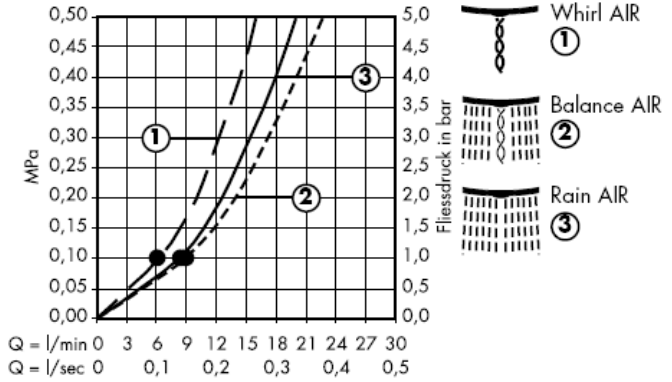

Sihtitiivisteellä (B)

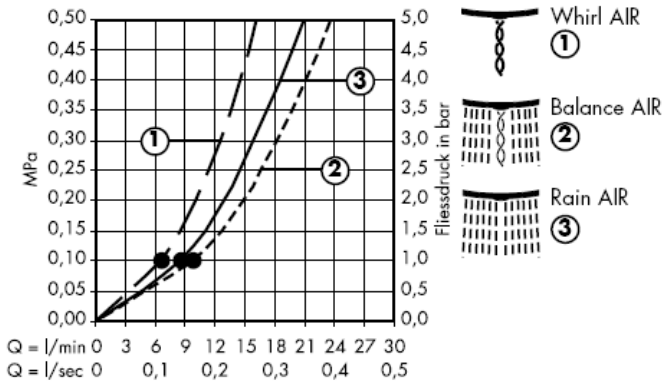

Tämä toiminta on taattuna • alkaen.

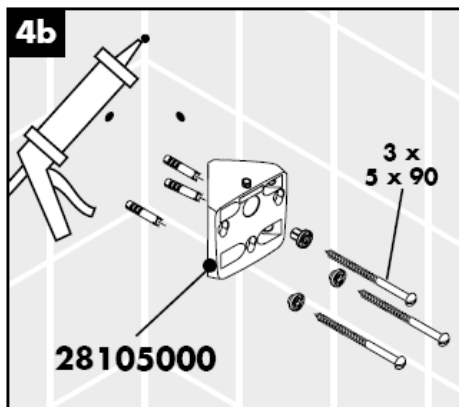
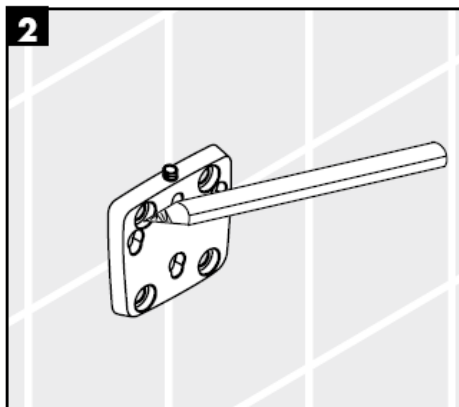
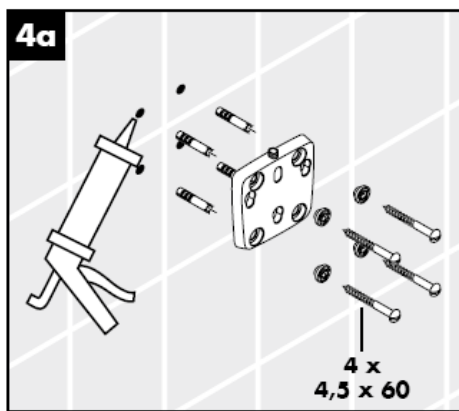
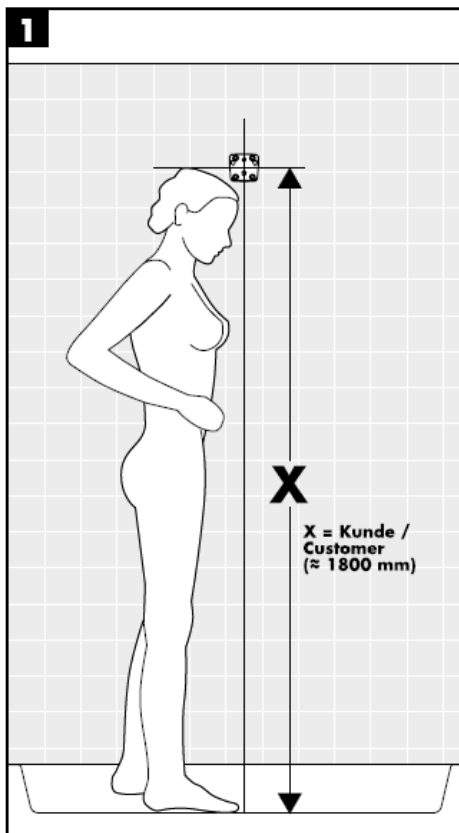

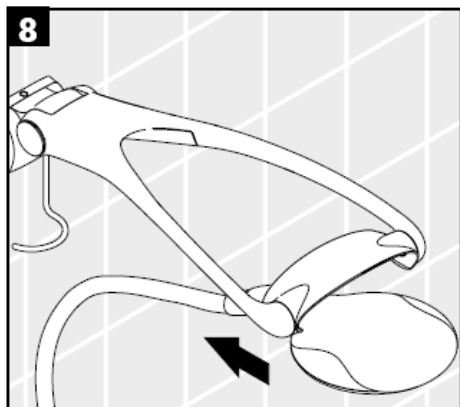
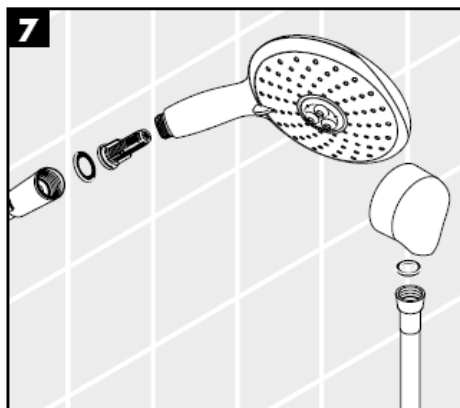
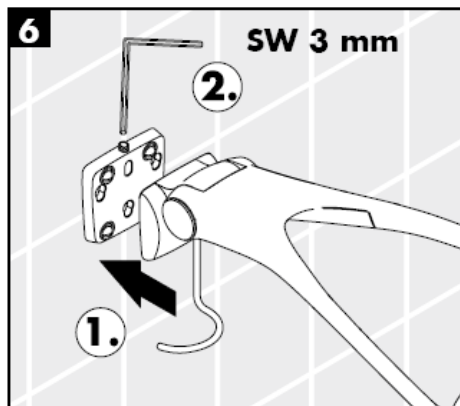
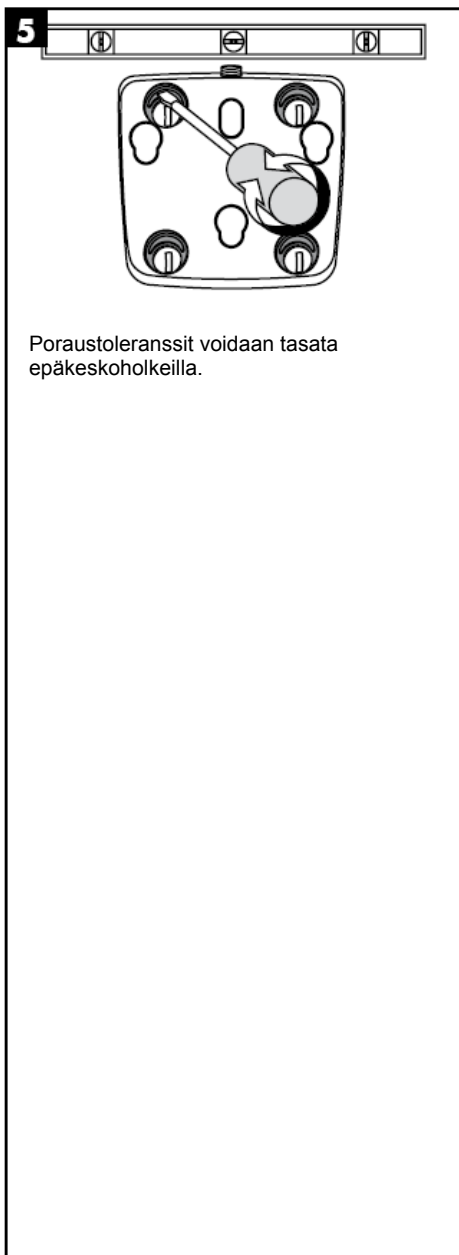

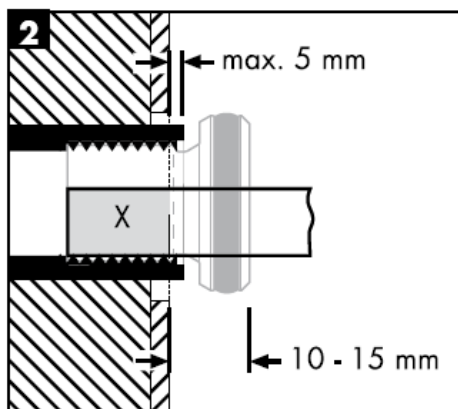
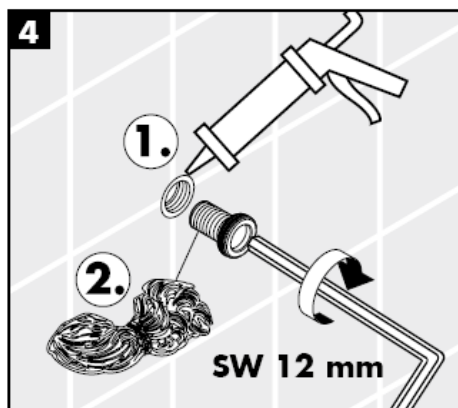
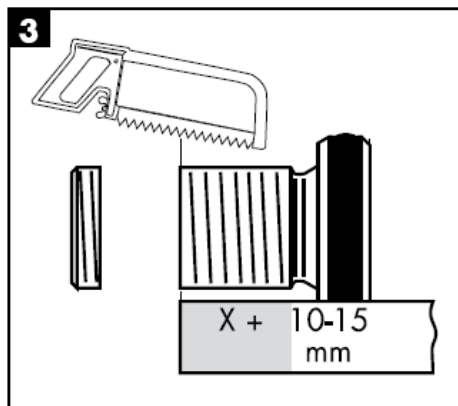
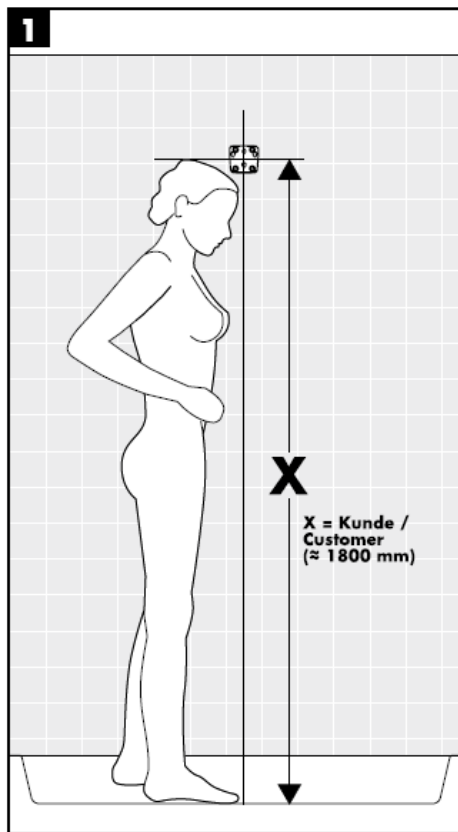

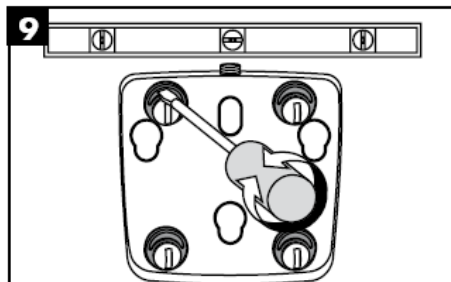
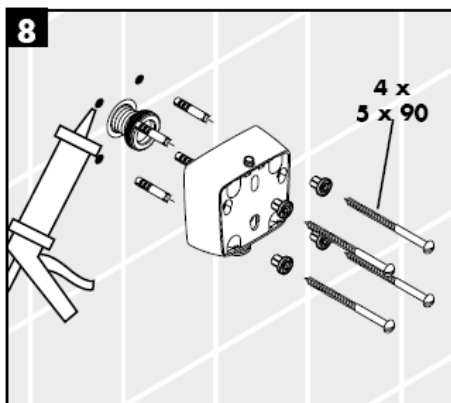
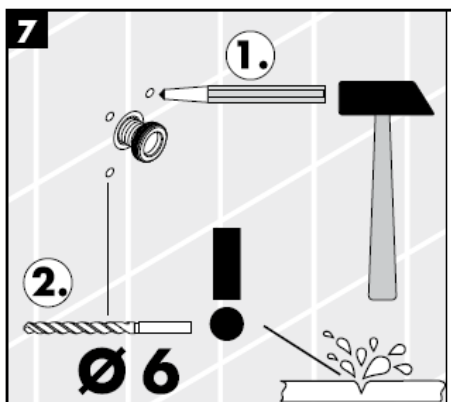
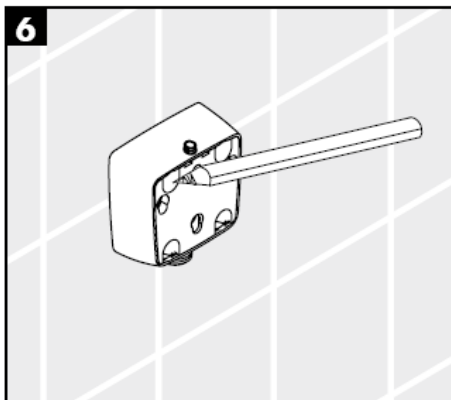

Poraustoleranssit voidaan tasata epäkeskokohteilla.

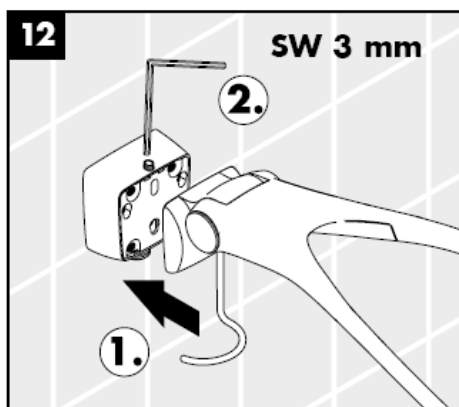
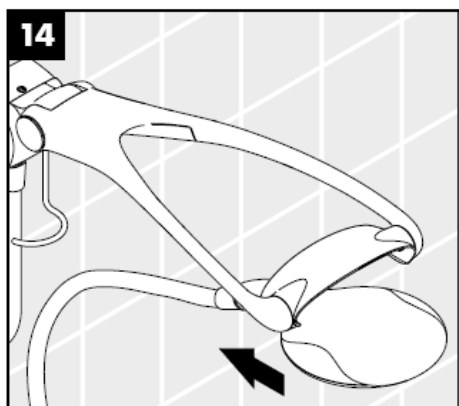
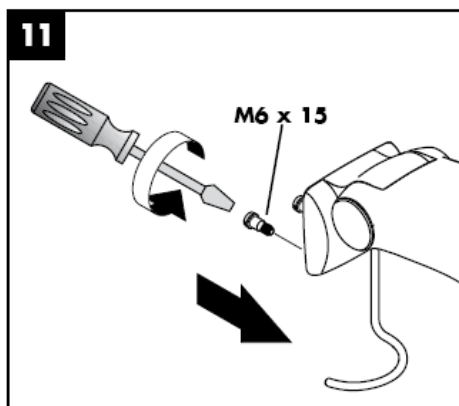
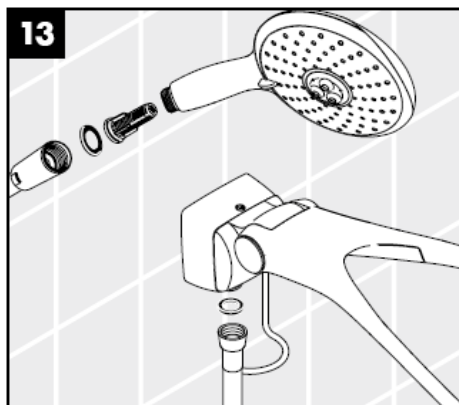
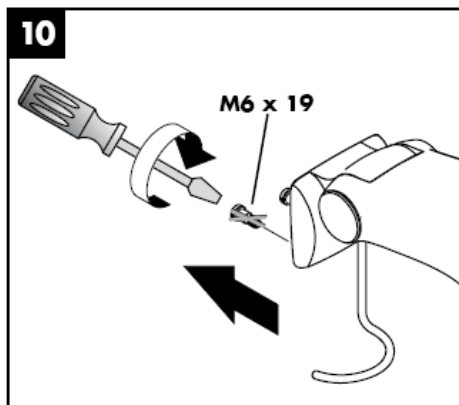



Allrounder Set on monitoimintainen suihkujärjestelmä. Kannatusvarren asennosta riippuen sitä voidaan käyttää pää-, sivu- ja erillisenä käsisuihkuna.

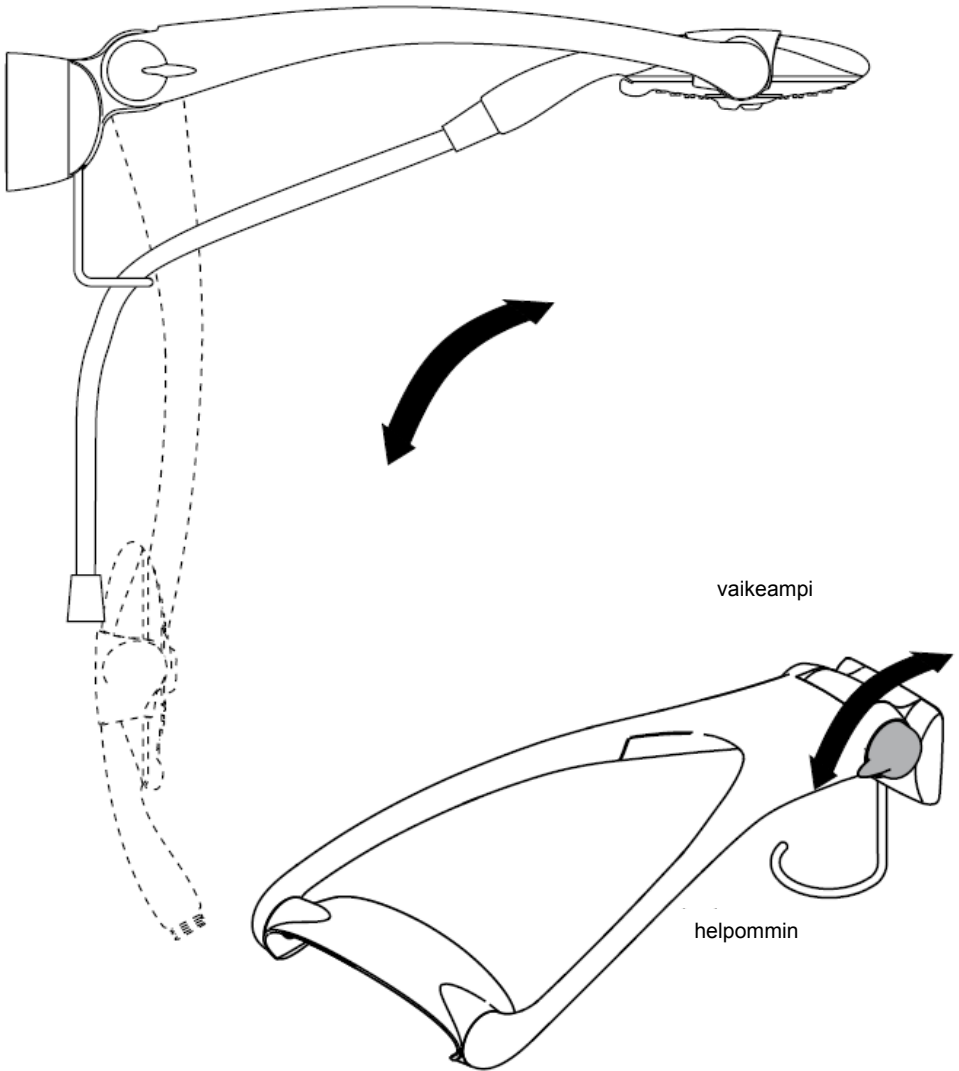

Rubit® –käsitoiminen kalkinpoistojärjestelmä on helppo käyttää: hiero sormella ja vedentulo on taas esteetön.

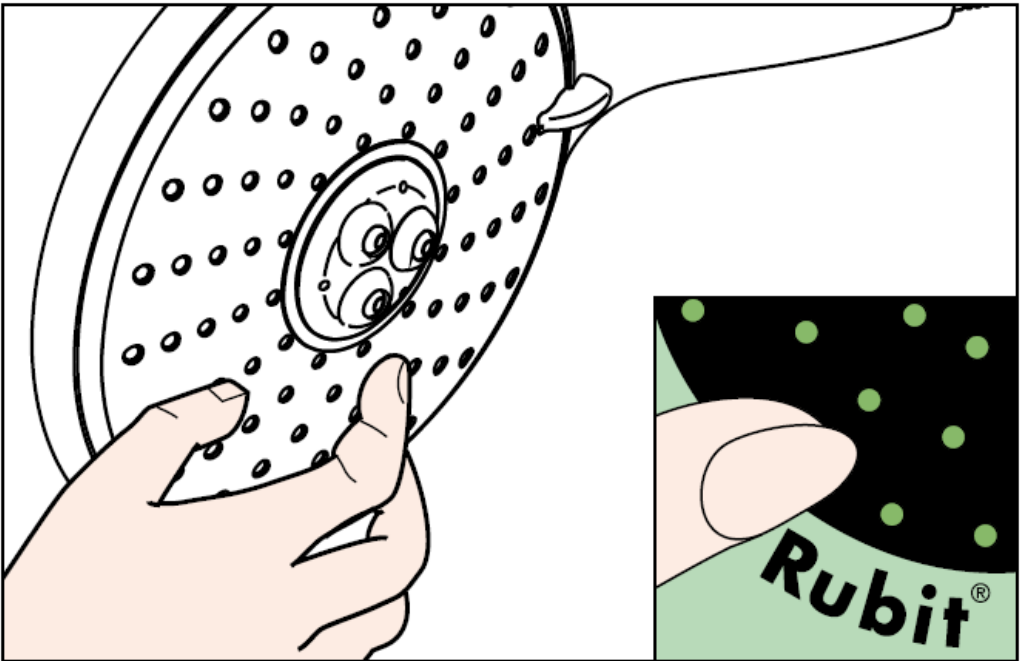

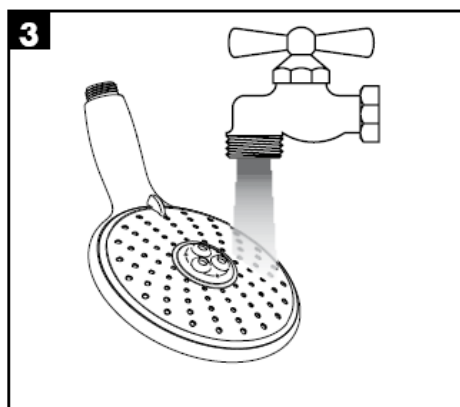
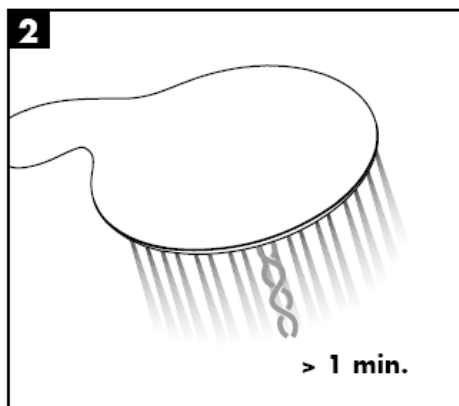
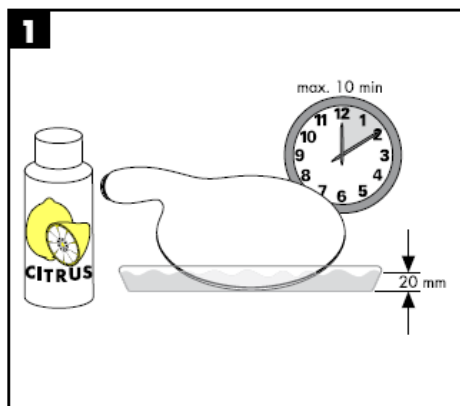

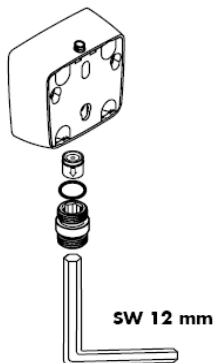

Huomio!

Vastaventtiin toiminta on normin DIN 1988 mukaan tarkastettava vuosittaan.

hansgrohe

Hansgrohe · Postfach 1145 · D-77761 Schiltach · Telefon +49 (0) 78 36/51-1282 · Telefax +49 (0) 7836/511440
E-Mail: info@hansgrohe.com · Internet: www.hansgrohe.com

02/2008
9.06081.04
Suomi

Monteringsanvisning

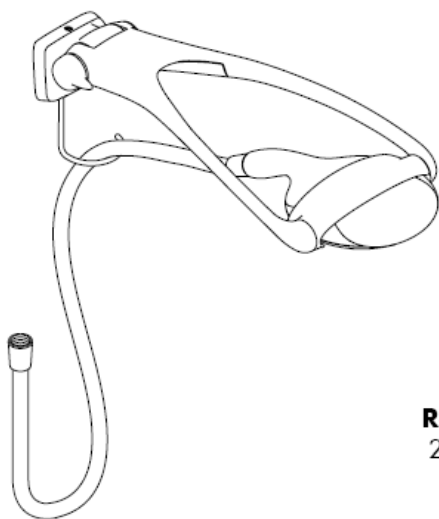

Raindance
28105000

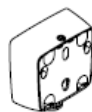

Raindance
28108000

Raindance Allrounder Set
28100000 / 28110000

hansgrohe

Raindance Allrounder Set

28100000 / 28110000

Classification acoustique et débit 28110000: ACS

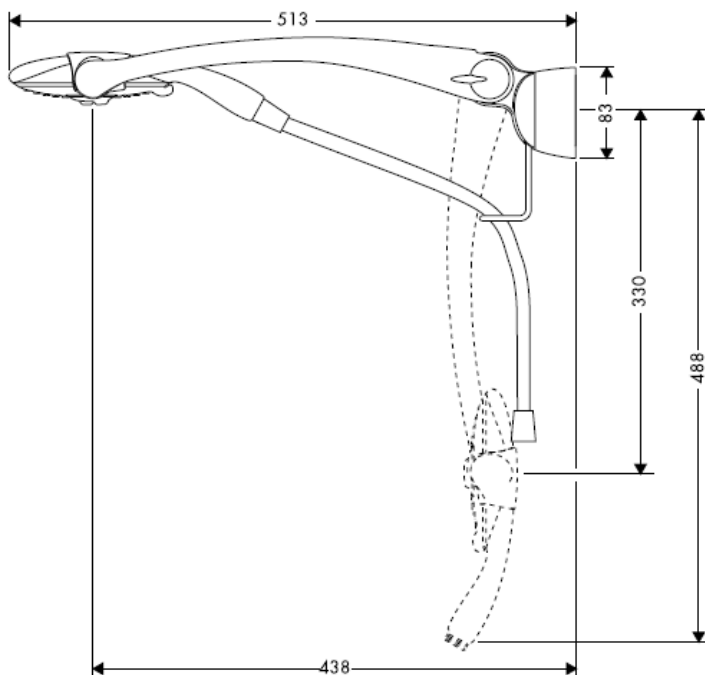

Raindance Eckmontage Set

28105000



Raindance UP-Adapter für Schlauchanschluß

28108000



Raindance Allrounder Set

28100000 / 28110000

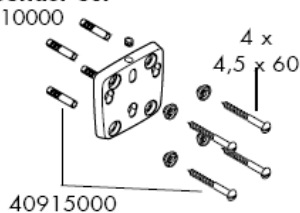

98562000

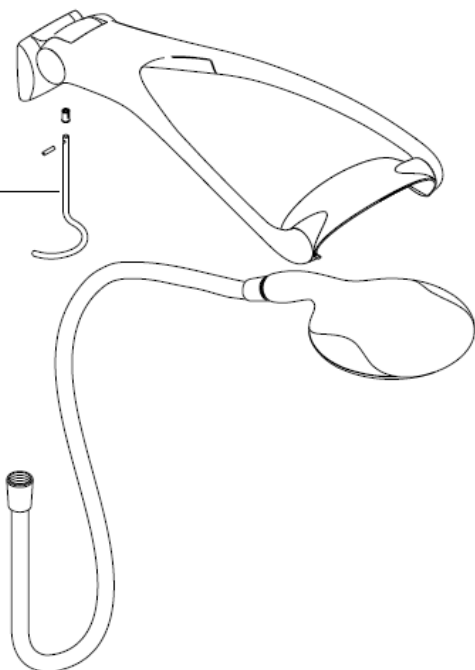

Raindance Eckmontage Set

28105000

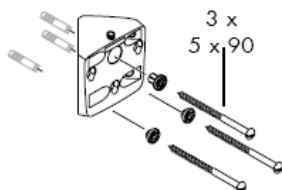

Raindance UP-Adapter für Schlauchanschluss

28108000

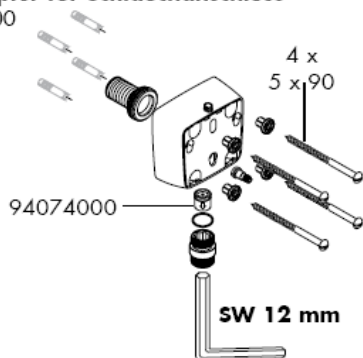

Montering

Filterinsatsen (A) som följer med måste monteras om normalflödet hos handduschen ska vara garanterat och för att undvika att smuts spolats in från ledningsnätet. Önskas kraftigare vattenflöde måste silpackningen (B) användas istället för filterinsatsen (A). Smuts som spolats in kan påverka funktionerna och/eller leda till skador på funktionsdelar i handduschen. Hansgrohe fransäger sig allt ansvar för skador som kan härledas till detta.

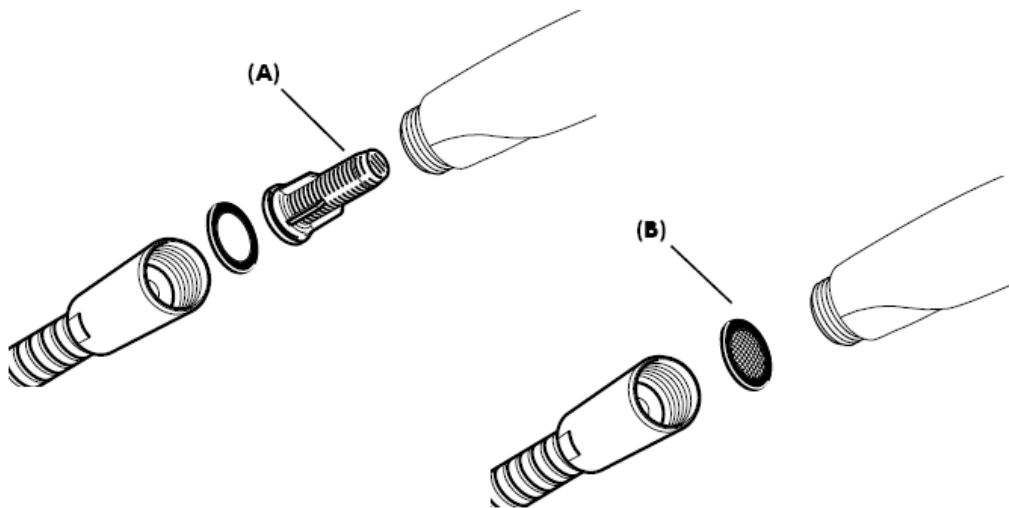

Med filterinsats (A)

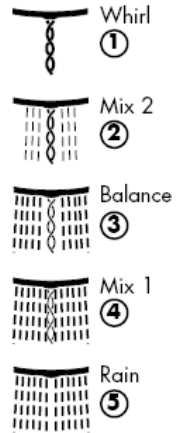
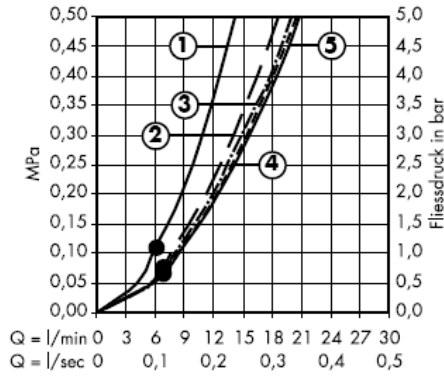

Med silpackning (B)

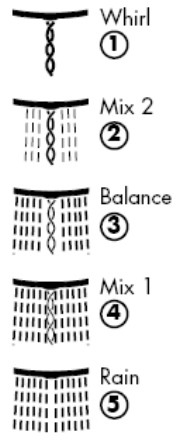
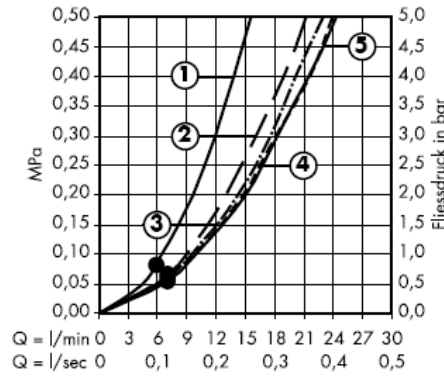

Från • garanteras funktionen.

Med filterinsats (A)

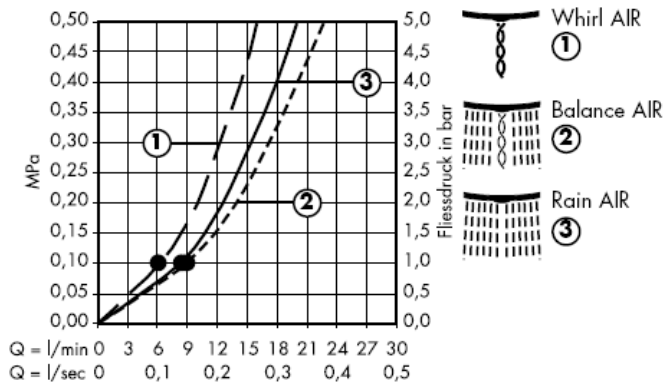

Med silpackning (B)

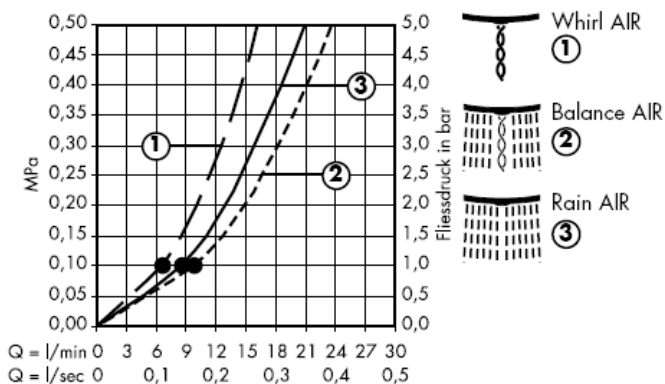

Från • garanteras funktionen.

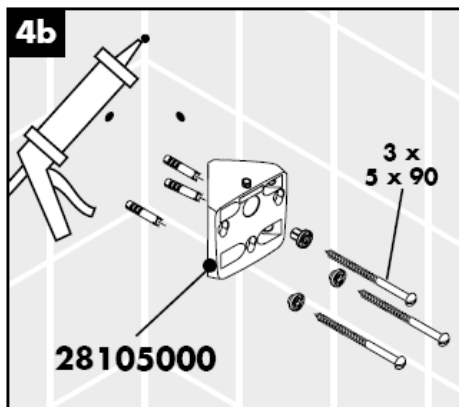
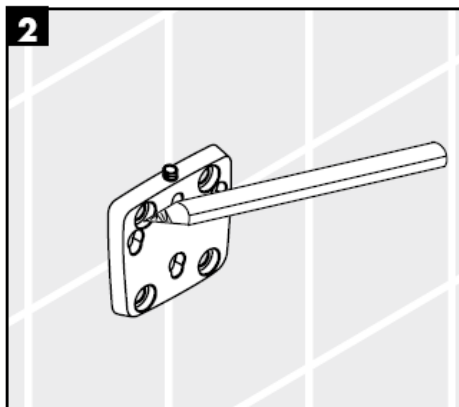

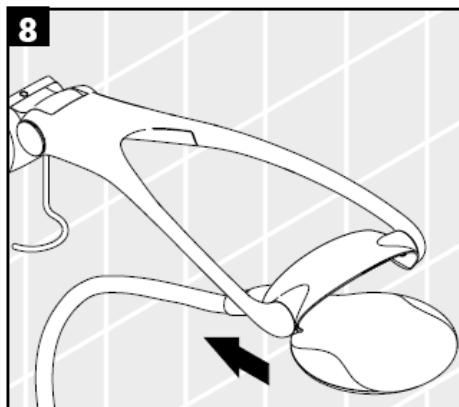
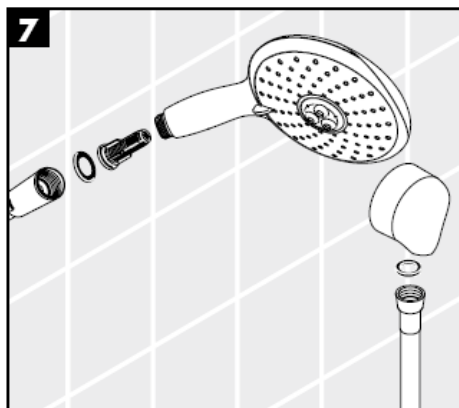
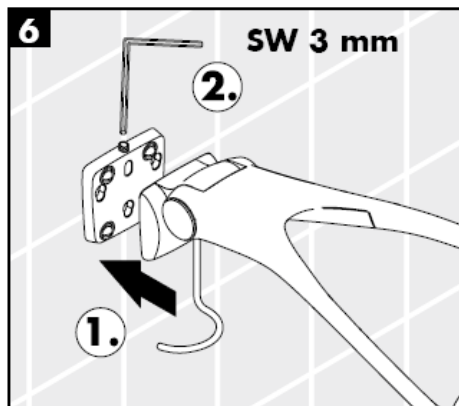

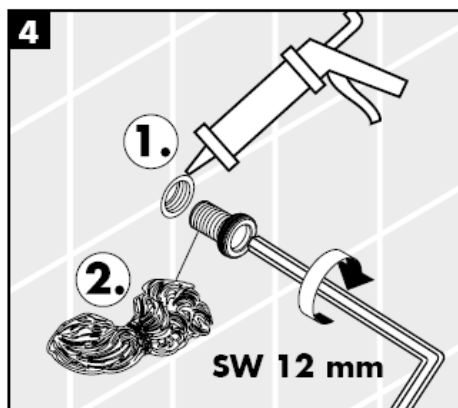
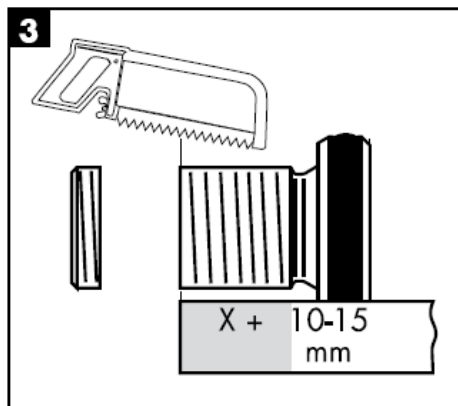
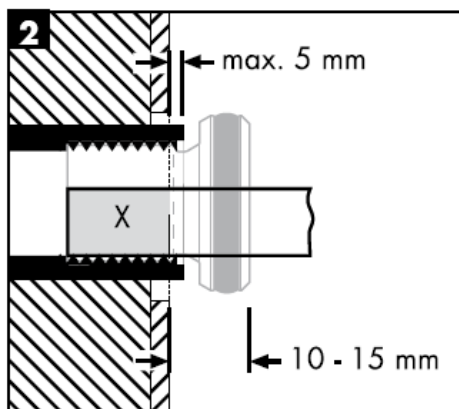
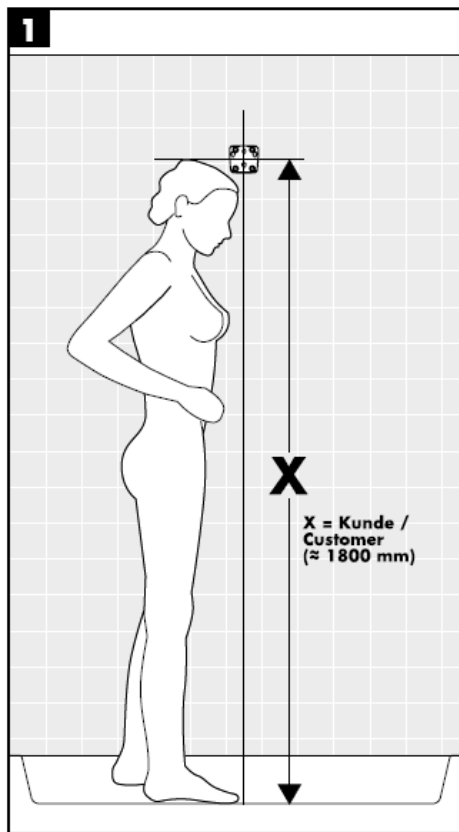

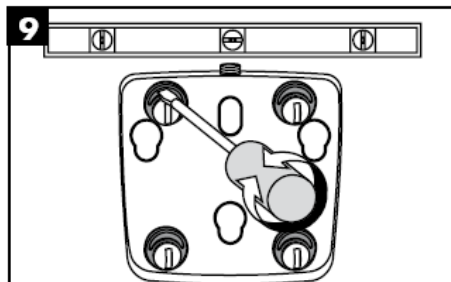
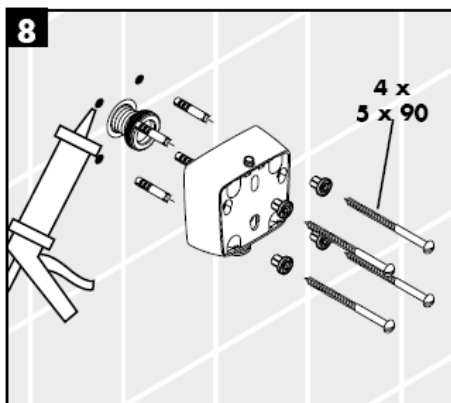
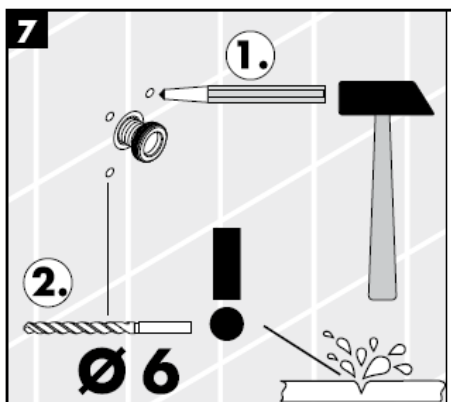
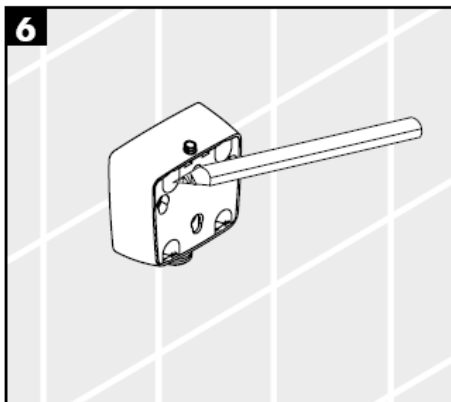

Borrtoleranser kan utjämnas genom excenterhylsan.





Allrounder Set är ett duschsystem med många funktioner. Allt efter bygelinställning kan huvud- eller sidoduschfunktioner, eller separat handdusch, användas.

Inställning av maxtemperatur

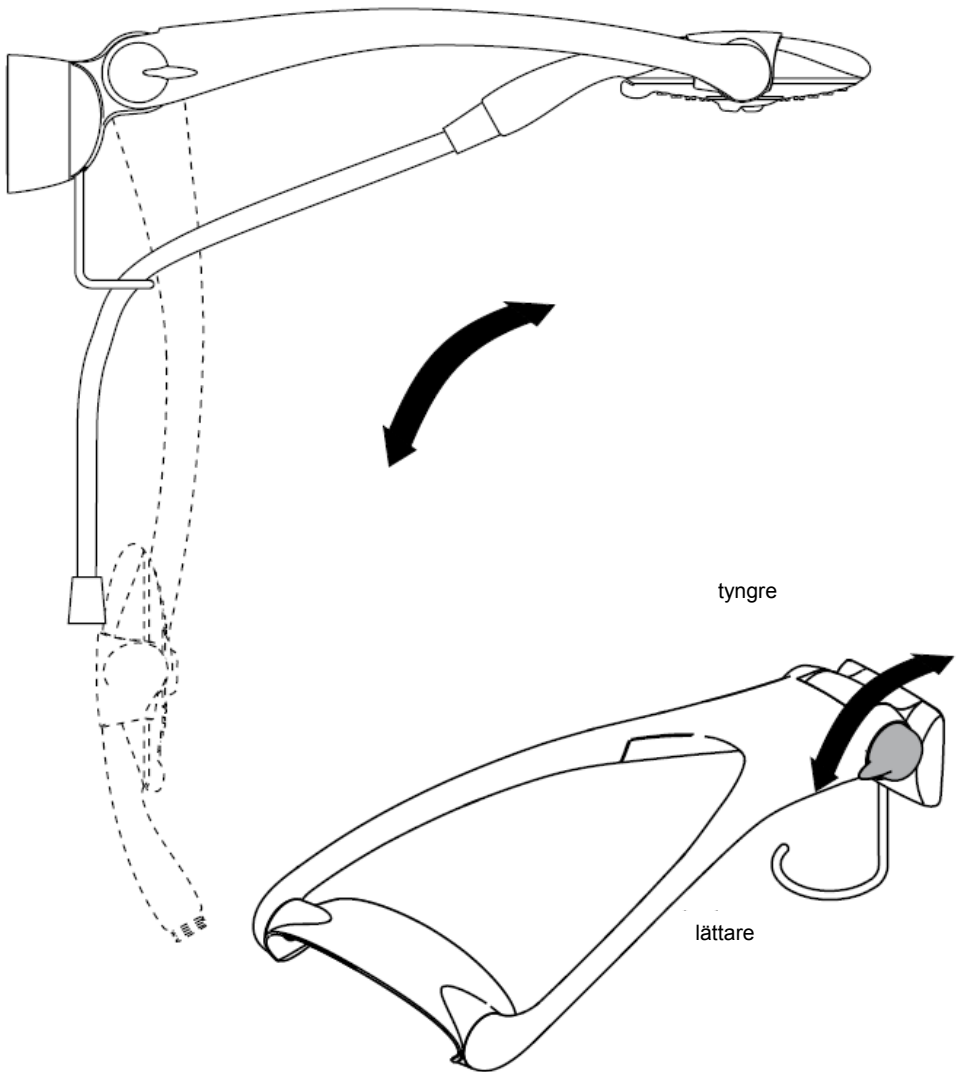

Rengöring

Med Rubit®, den manuella rengöringsfunktionen, är det lätt att befria strålkanelerna från kalk - de ska bar gnuggas.

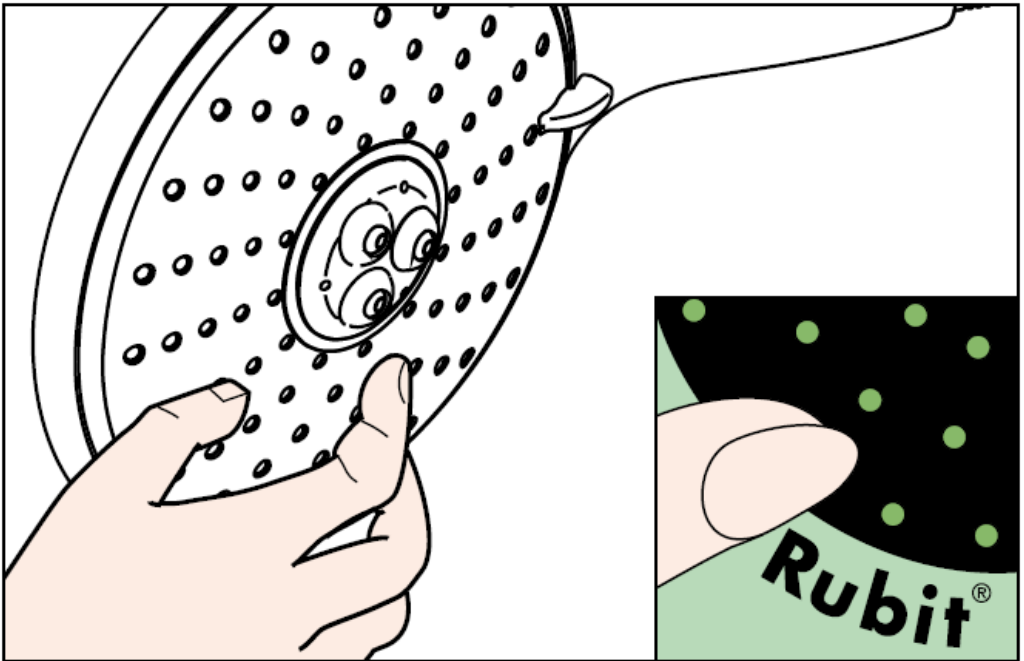

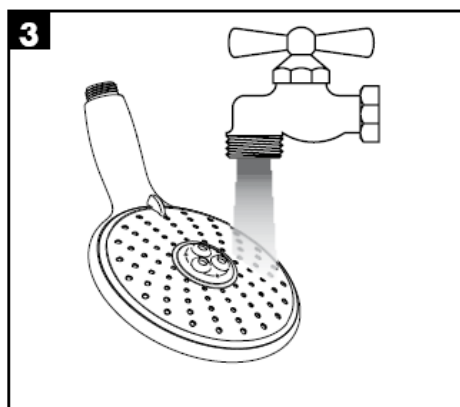
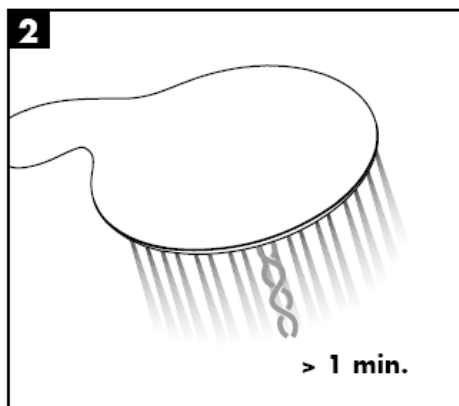
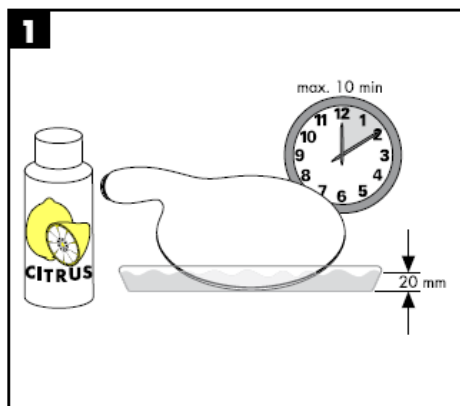

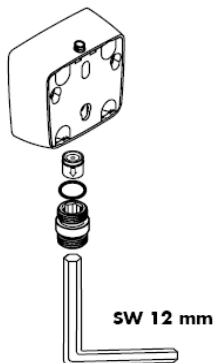

OBS!

Backventilernas funktion måste kontrolleras en gång varje år enligt DIN 1988.

hansgrohe

Hansgrohe · Postfach 1145 · D-77761 Schiltach · Telefon +49 (0) 78 36/51-1282 · Telefax +49 (0) 7836/511440
E-Mail: info@hansgrohe.com · Internet: www.hansgrohe.com

02/2008
9.06081.04
Svenska

Montavimo instrukcijos

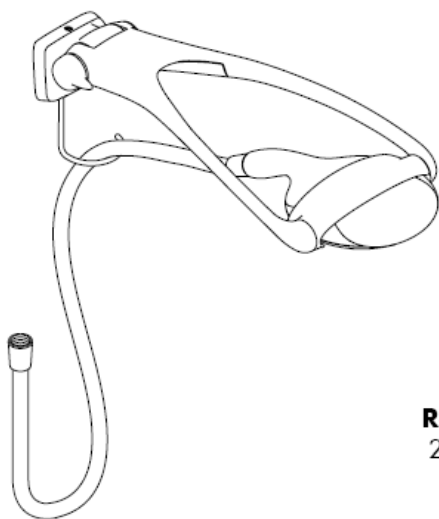

Raindance
28105000

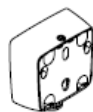

Raindance
28108000

Raindance Allrounder Set
28100000 / 28110000

hansgrohe

Raindance Allrounder Set

28100000 / 28110000

Classification acoustique et débit 28110000: ACS

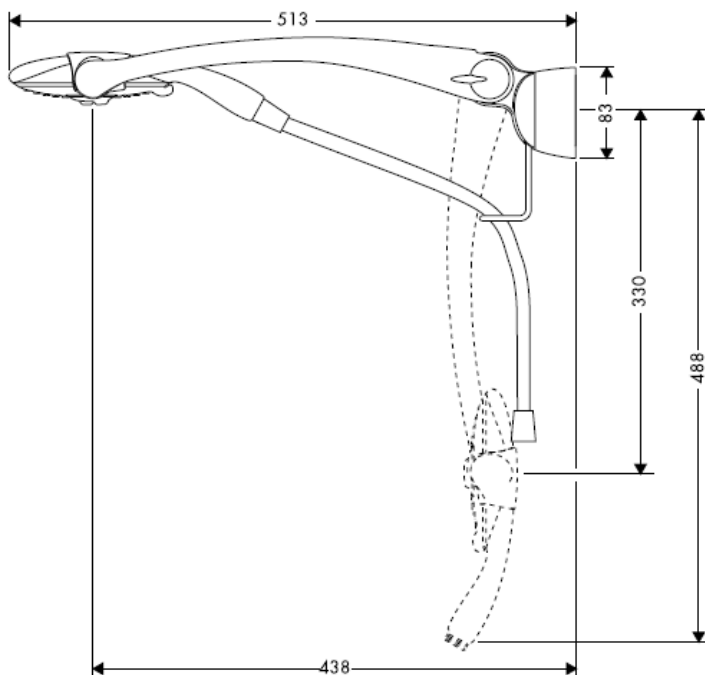

Raindance Eckmontage Set

28105000



Raindance UP-Adapter für Schlauchanschluß

28108000



Raindance Allrounder Set

28100000 / 28110000

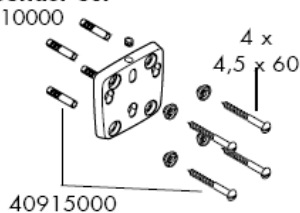

98562000

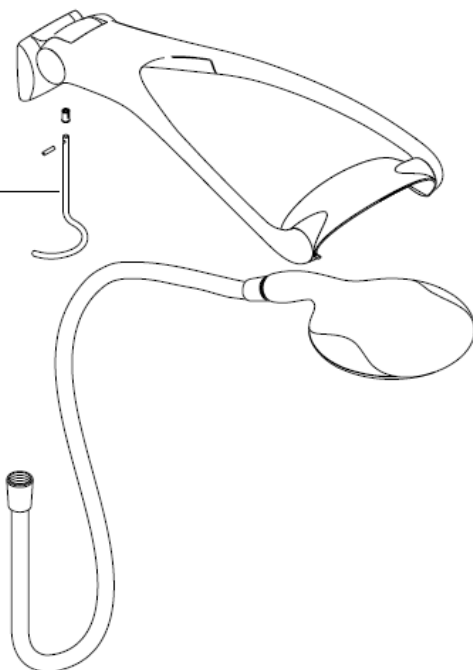

Raindance Eckmontage Set

28105000

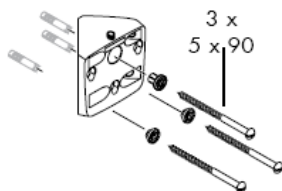

Raindance UP-Adapter für Schlauchanschluss

28108000

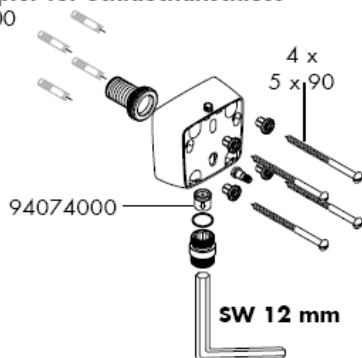

Montavimas

Filtrą (A), kuris yra rankų dušas pakuotėje, privalo būti įstatytas, kad būtų garantuota vandens pralaidumo norma ir apsauga nuo nešvarumų. Jei reikia didesnio vandens pralaidumo, vietoje filtro (A) įstatykite sietelį (B). Nešvarumai gali pakenkti rankų dušas funkcionalumui ir (arba) sugadinti rankų dušas funkcines dalis. Tokiu atveju "Hansgrohe" atsakomybės neprisiima.

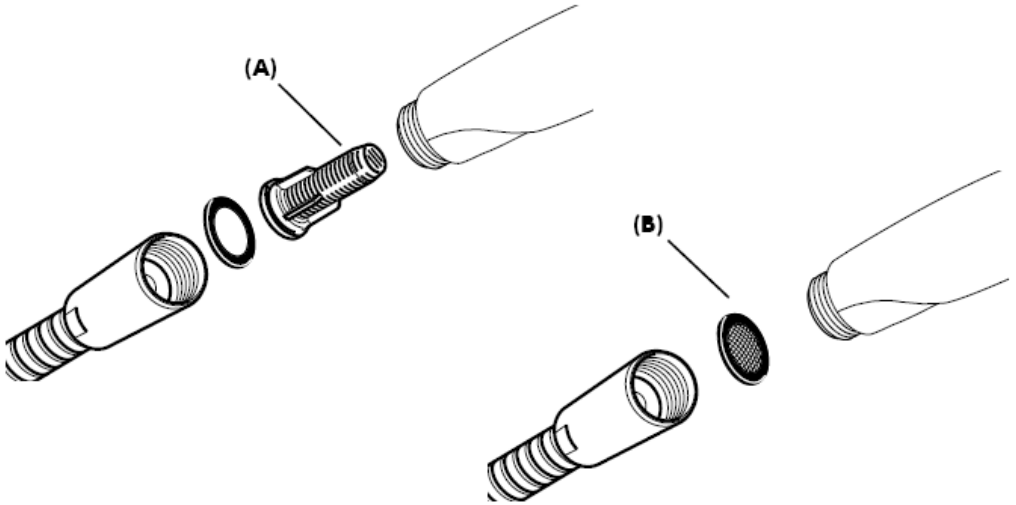

Su filtru (A)

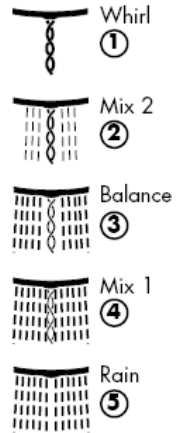
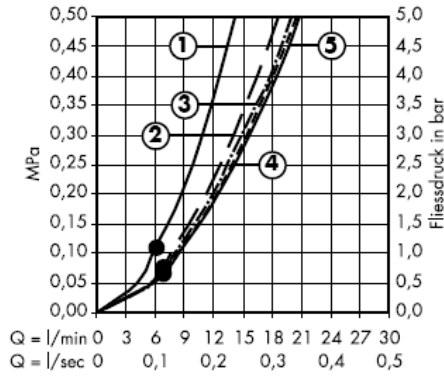

Su sieteliu (B)

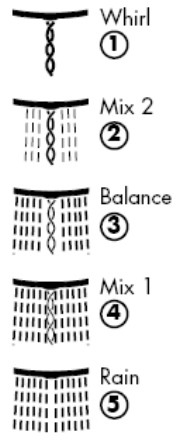
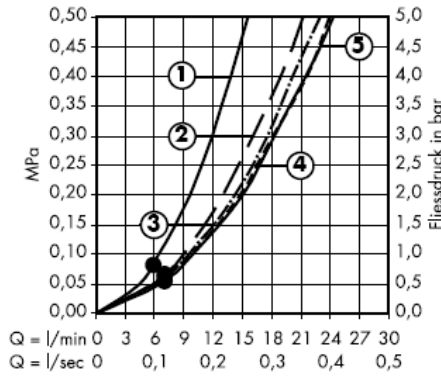

Nuo • funkcionavimas garantuotas

Su filtru (A)

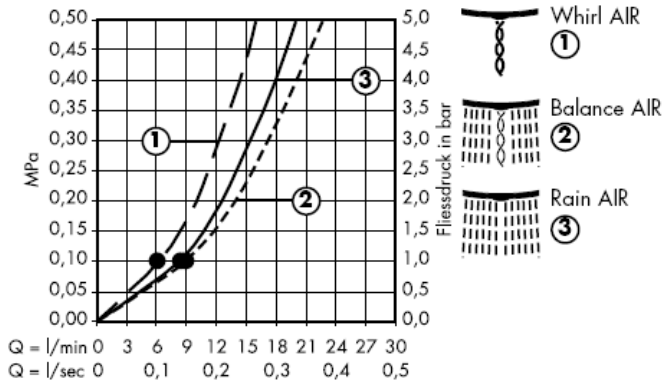

Su sieteliu (B)

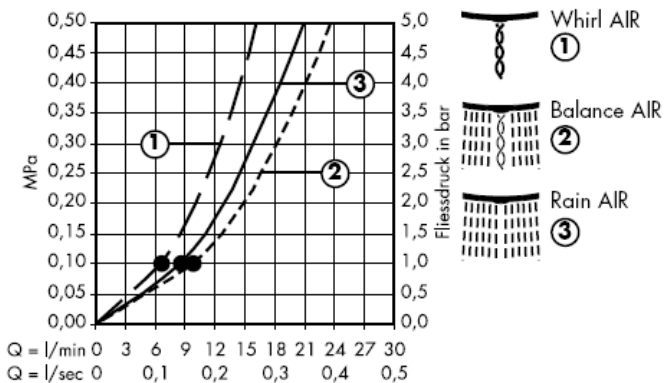

Nuo • funkcionavimas garantuotas

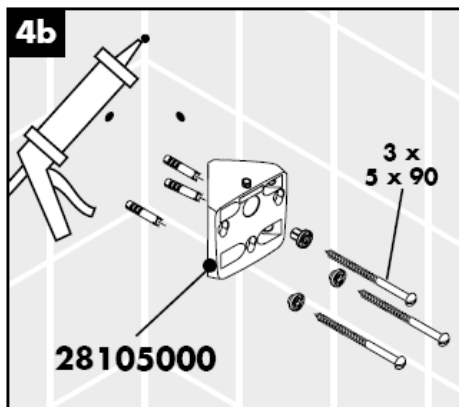
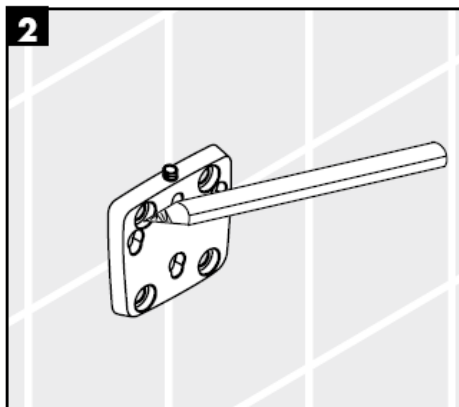

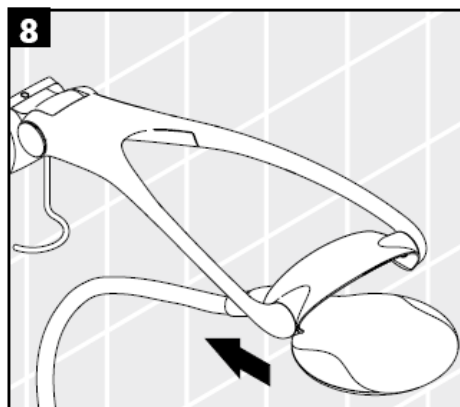
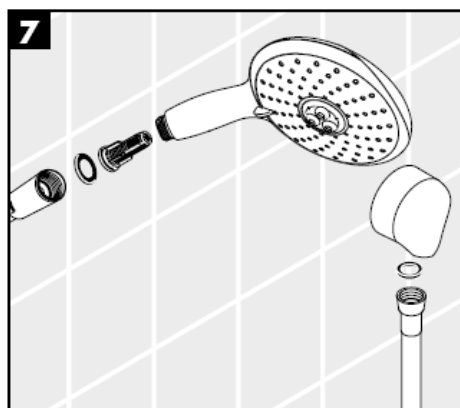
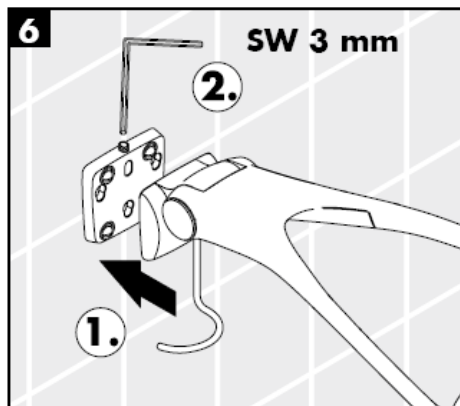
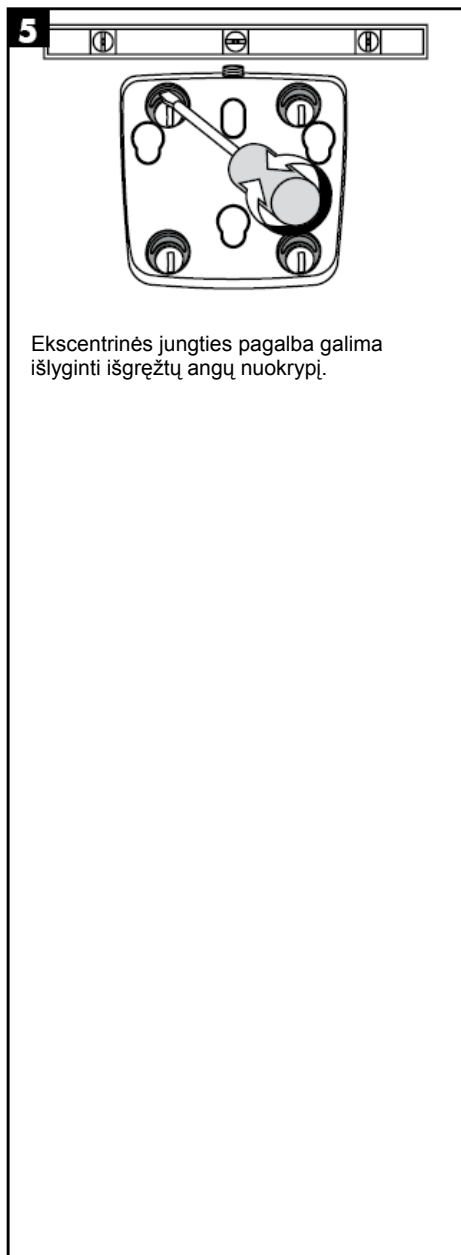

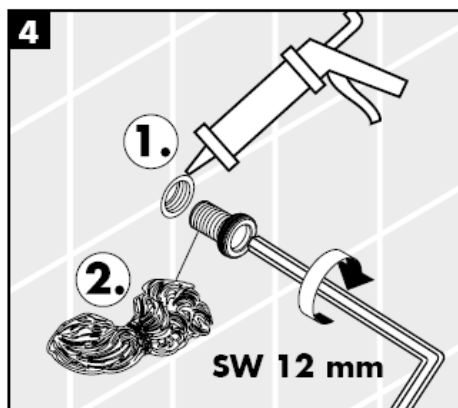
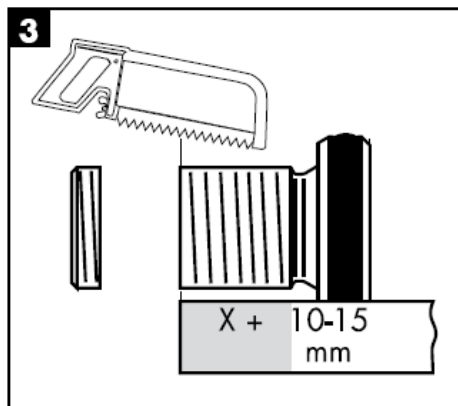
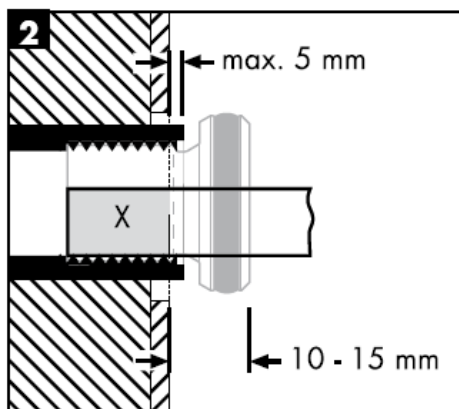
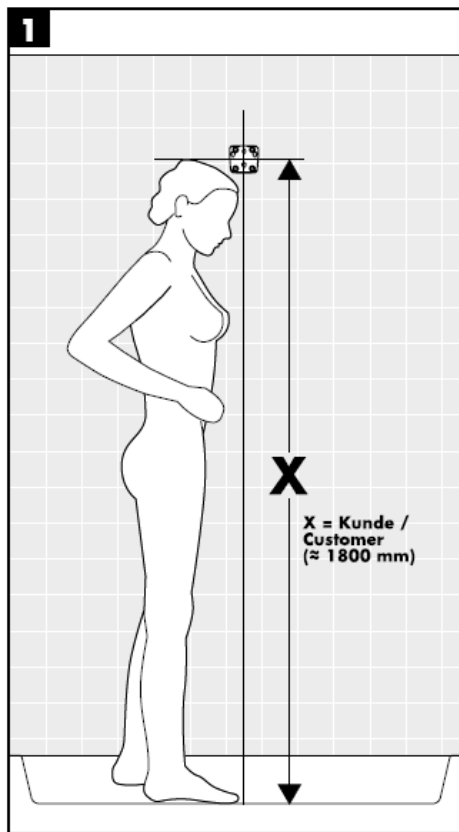

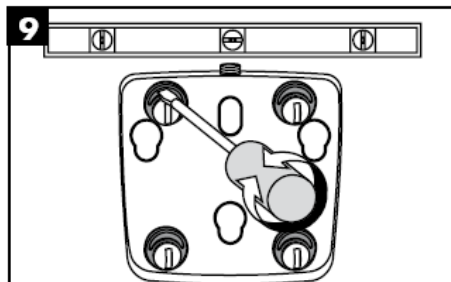
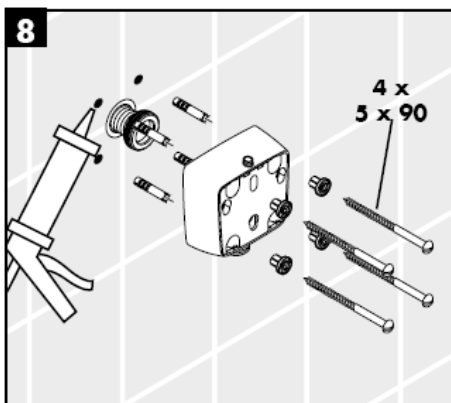
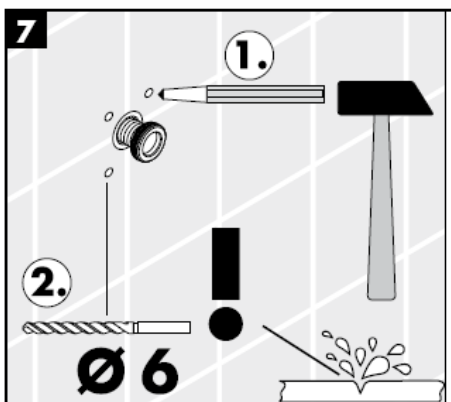
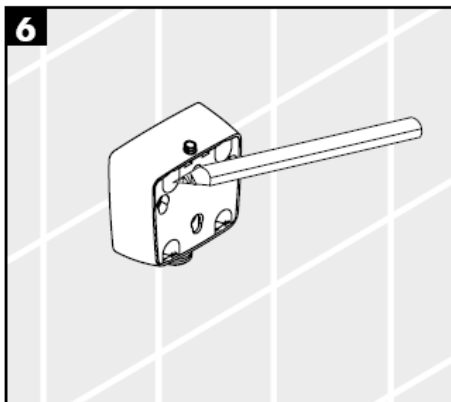

Ekscentrinės jungties pagalba galima išlyginti išgręžtų angų nuokrypį.

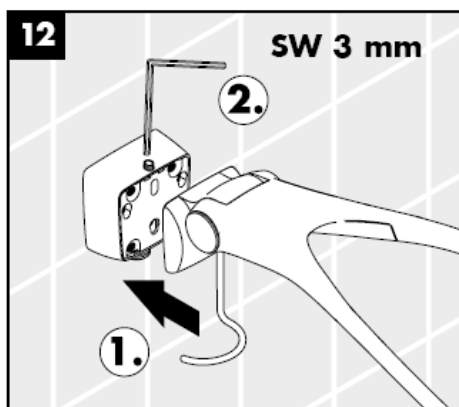
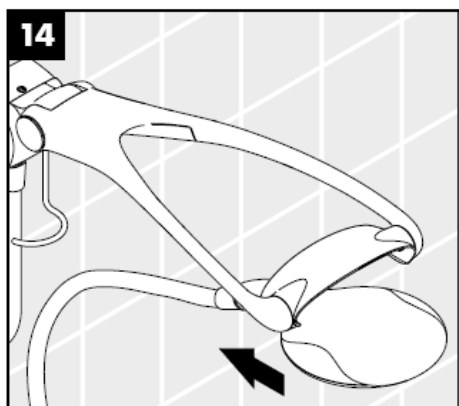
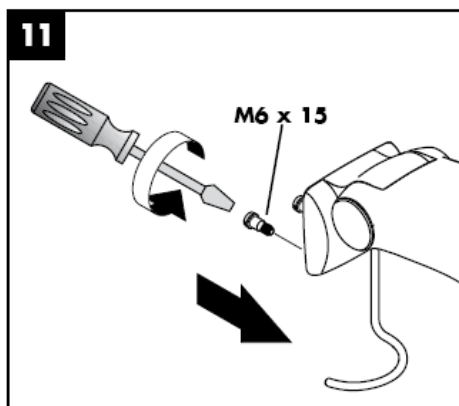
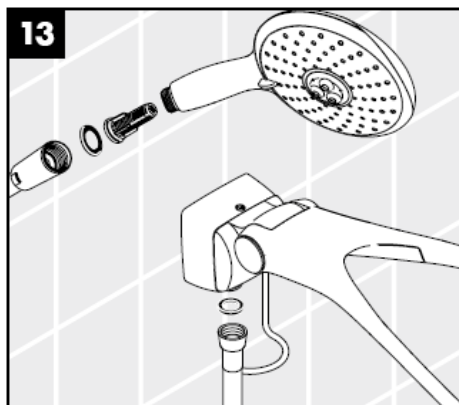
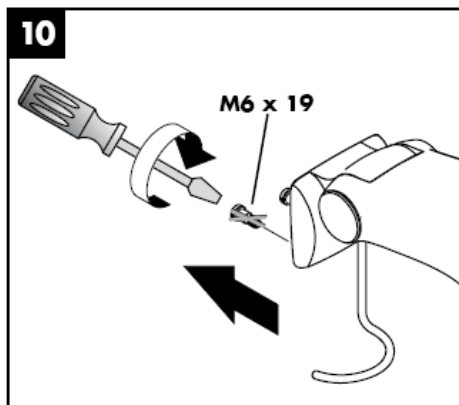



"Allrounder" yra daigiafunkcinė dušo sistema. Priklausomai nuo rankenėlės padėties, galima įjungti galvos dušo, šoninių purkštukų arba rankų dušo funkcijas.

Nustatymas

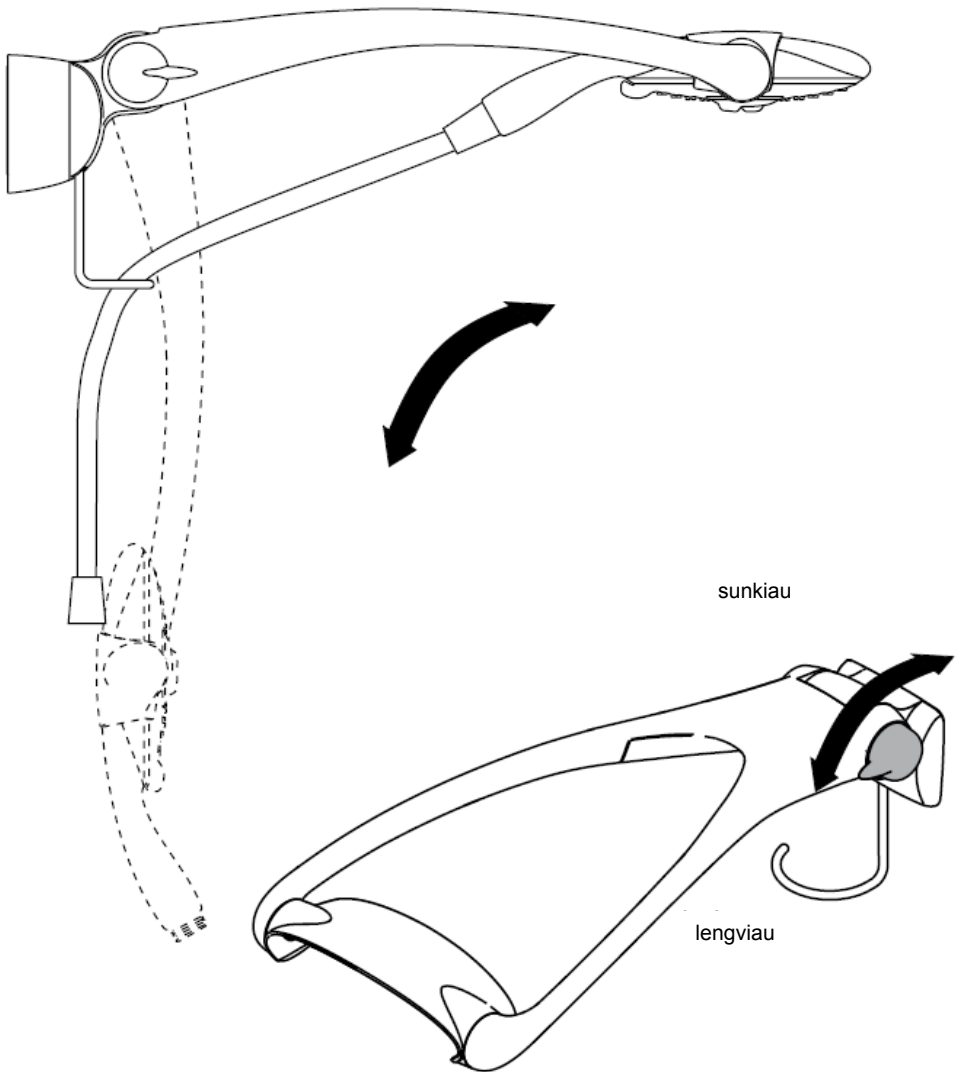

Valymas

"Rubit®" valymo funkcija apsaugo nuo apkalkėjimo. Užtenka pirštu nubraukti atsiradusius nešvarumus nuo srovės angų.

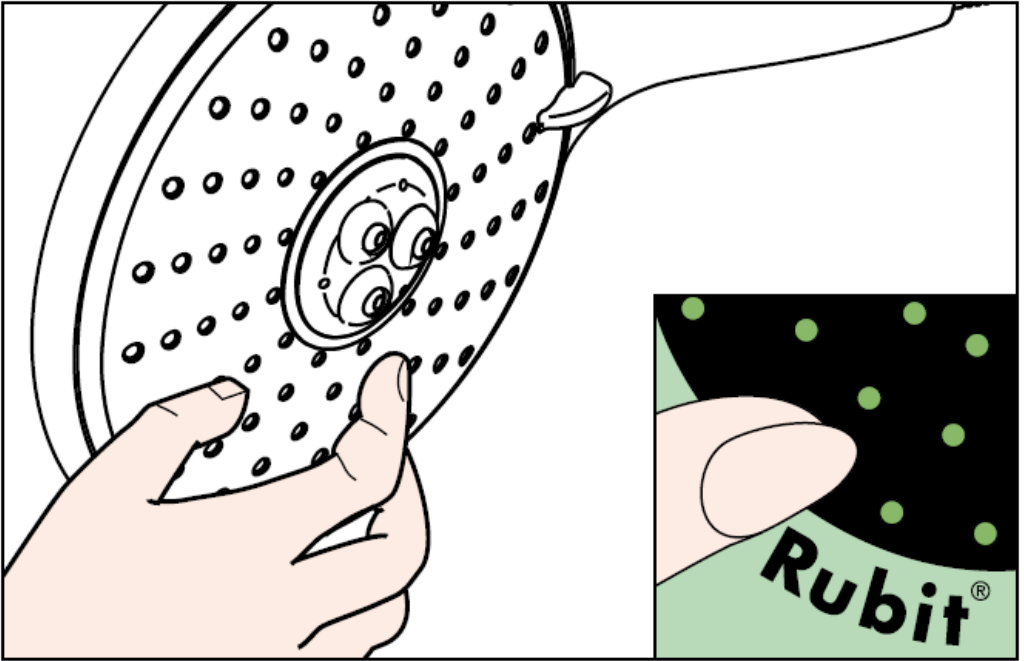

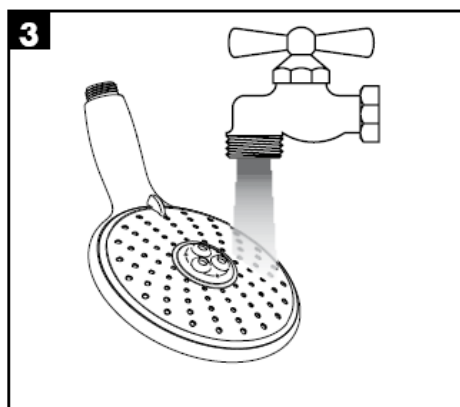
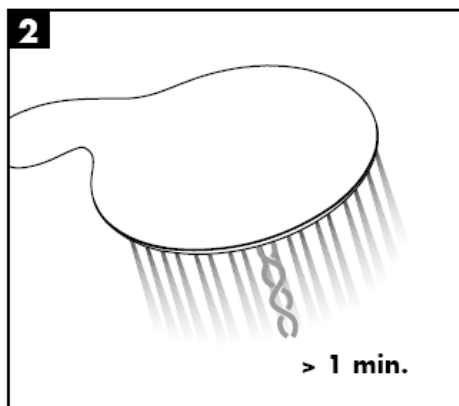
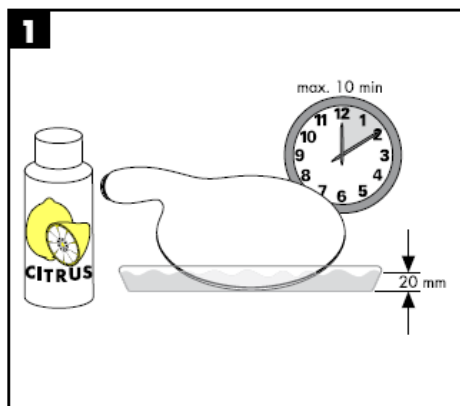

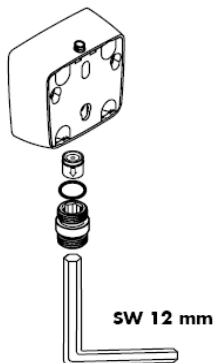

Dėmesio!

Atbulinių vožtuvėlių funkcija, remiantis DIN 1988, vieną kartą metuose privalo būti patikrinta.

hansgrohe

Hansgrohe · Postfach 1145 · D-77761 Schiltach · Telefon +49 (0) 78 36/51-1282 · Telefax +49 (0) 7836/511440
E-Mail: info@hansgrohe.com · Internet: www.hansgrohe.com

02/2008
9.06081.04
Lietuviškai

Uputstva za instalaciju

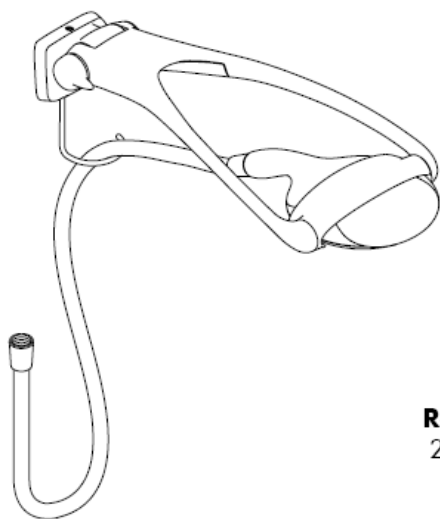

Raindance
28105000

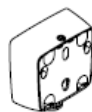

Raindance
28108000

Raindance Allrounder Set
28100000 / 28110000

hansgrohe

Raindance Allrounder Set

28100000 / 28110000

Classification acoustique et débit 28110000: ACS

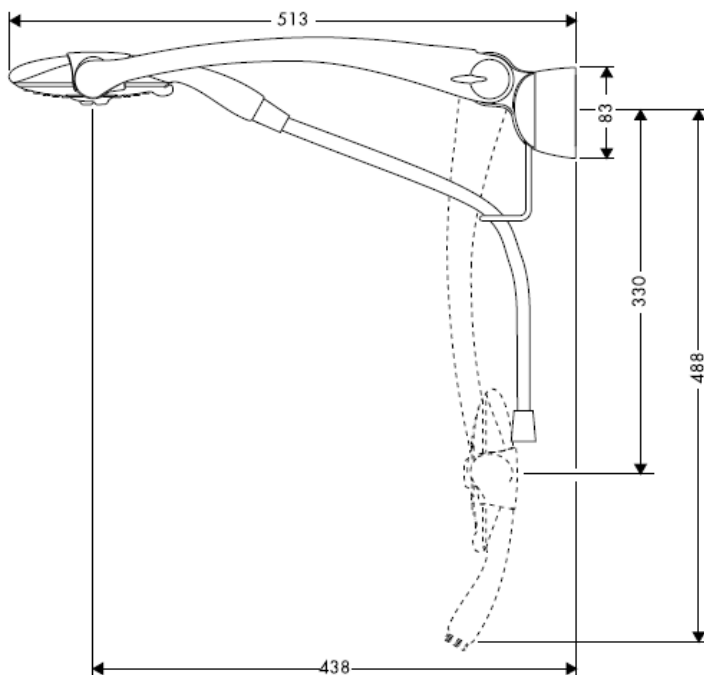

Raindance Eckmontage Set

28105000



Raindance UP-Adapter für Schlauchanschluß

28108000



Raindance Allrounder Set

28100000 / 28110000

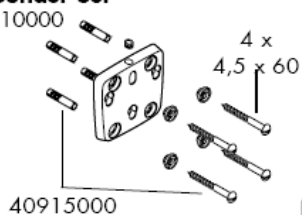

98562000

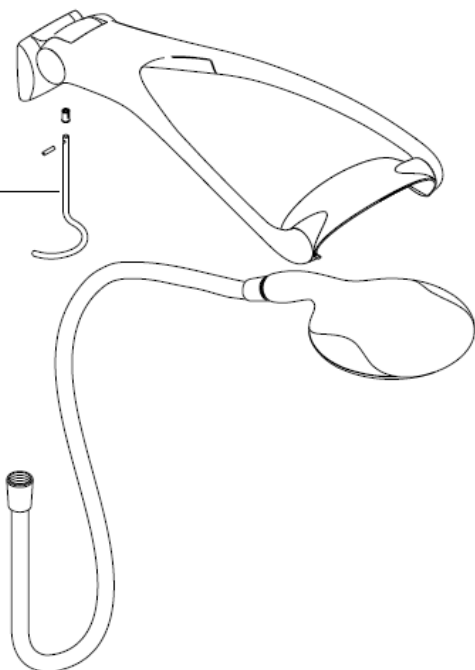

Raindance Eckmontage Set

28105000

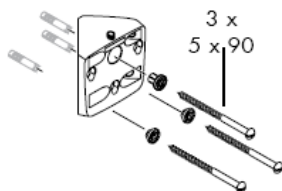

Raindance UP-Adapter für Schlauchanschluss

28108000

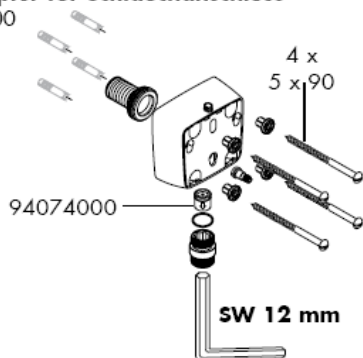

Sastavljanje

Filter (A) potrebno je ugraditi kako bi se regulirao protok vode i smanjio prolazak prljavštine. Ako želite jači protok vode umjesto filtera ugradite rešetku (B). Za eventualna oštećenja uzrokovana prljavštinom proizvođač Hansgrohe nije odgovoran.

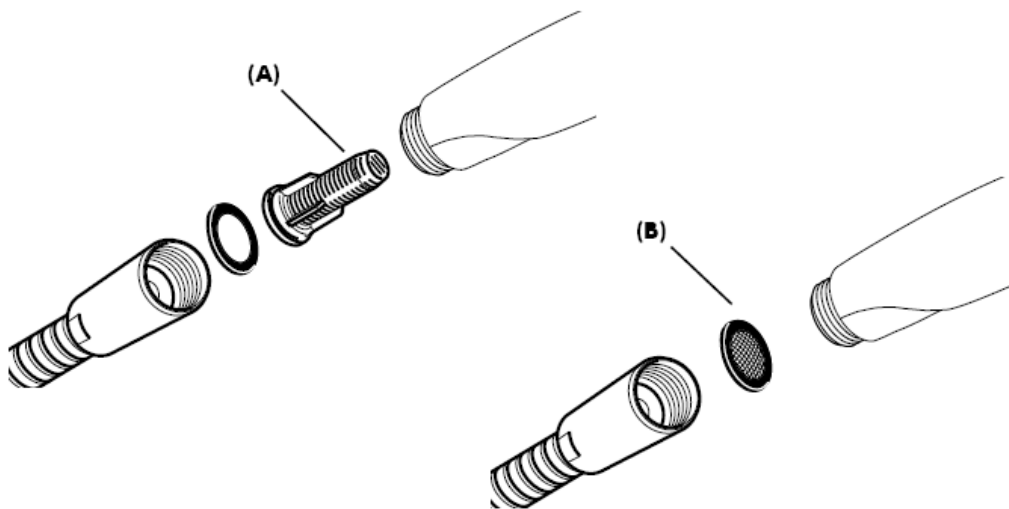

Sa filterom (A)

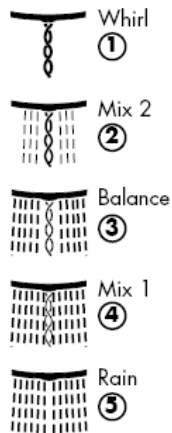
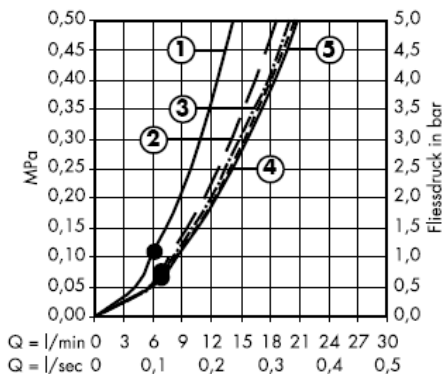

Sa rešetkastim filterom (B)

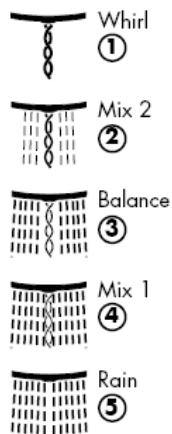
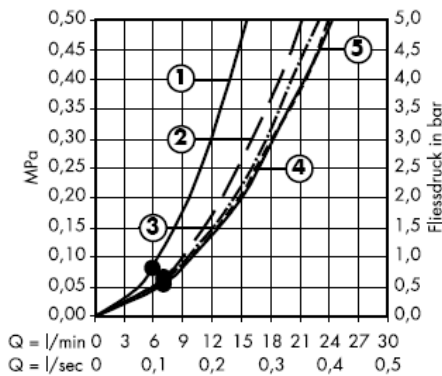

Zajamčena funkcija od • naviše

Sa filterom (A)

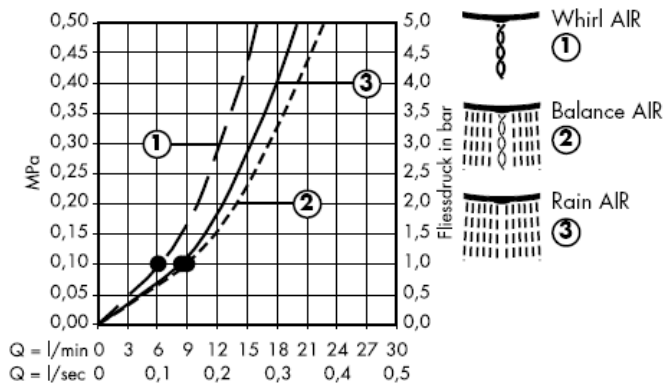

Sa rešetkastim filterom (B)

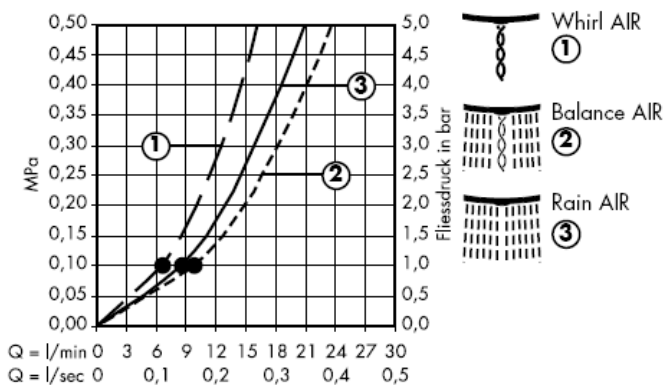

Zajamčena funkcija od • navíše

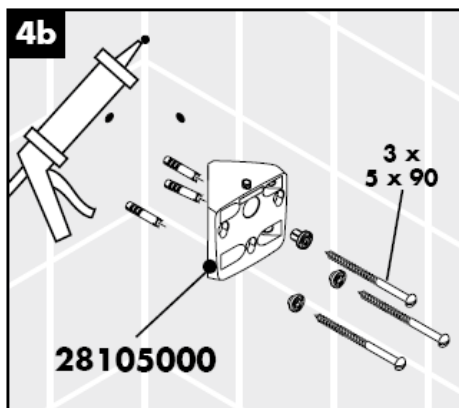
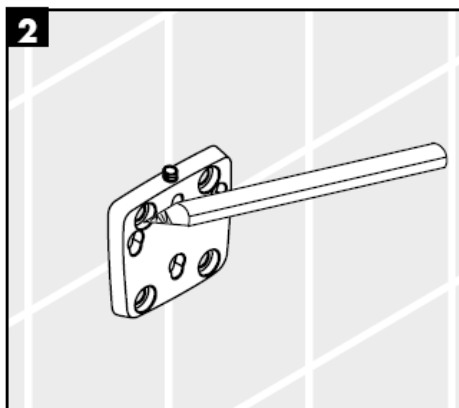

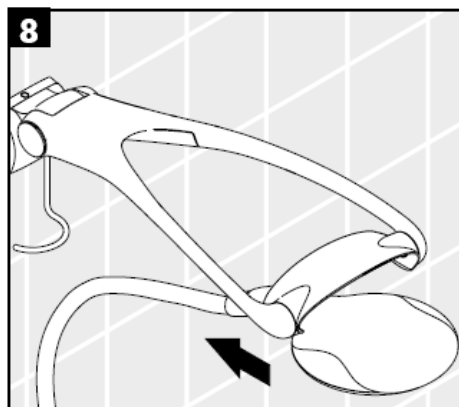
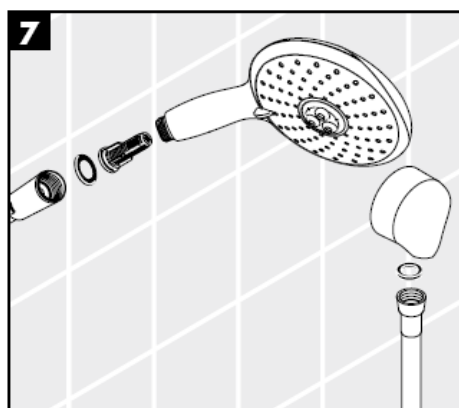
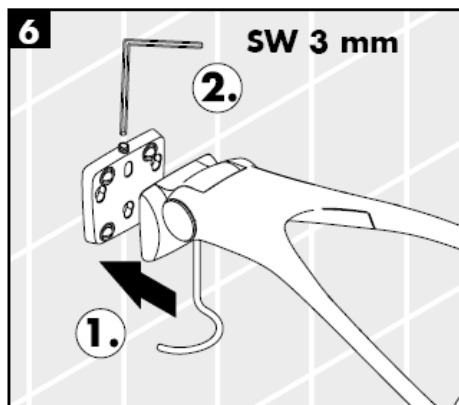

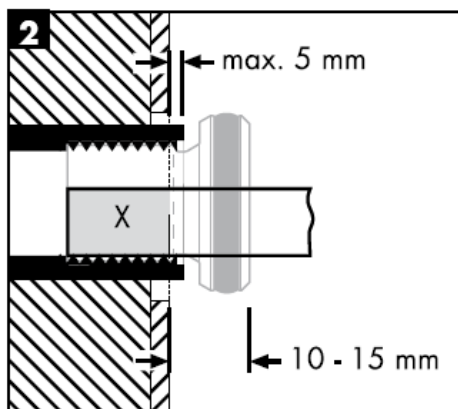
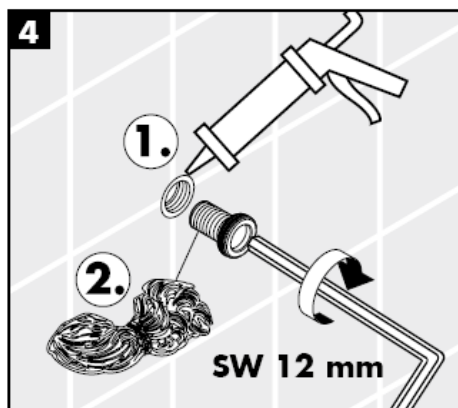
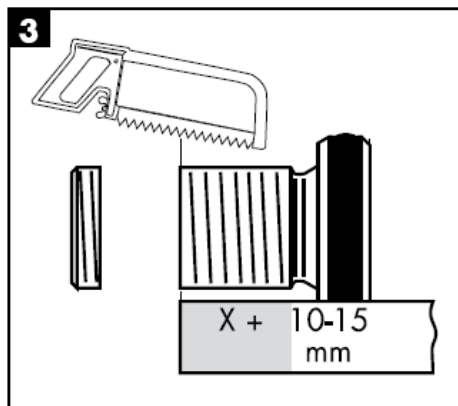
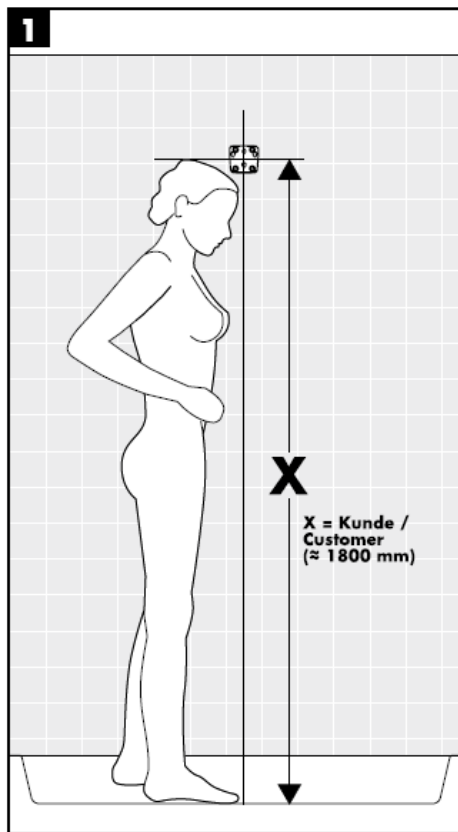

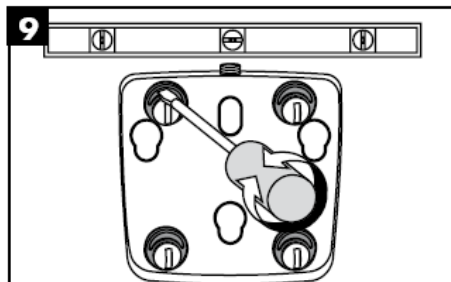
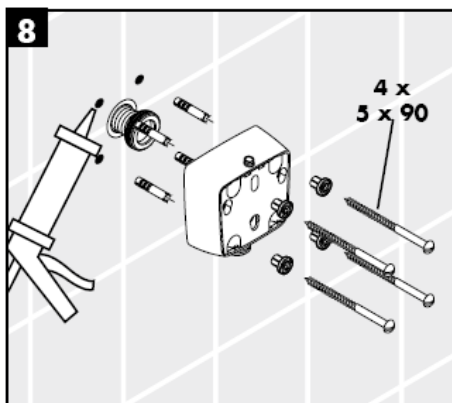
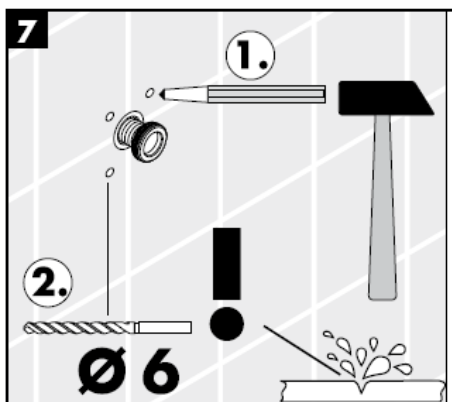
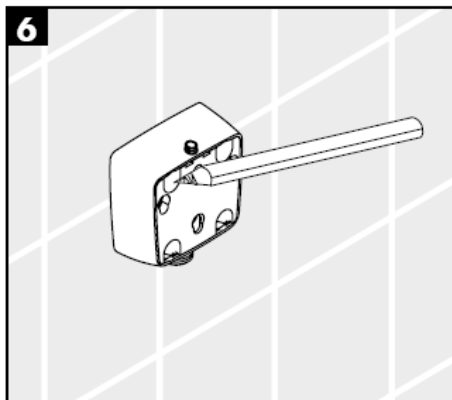

Pomoću ekscentara mogu se podesiti tolerancije provrta.





Allrounder set je multifunkcionalan sustav tuševa. Već prema poziciji držača može se koristiti bočno ili visoko prskanje, a pri tuširanju se zasebno može koristiti i ručka tuša.

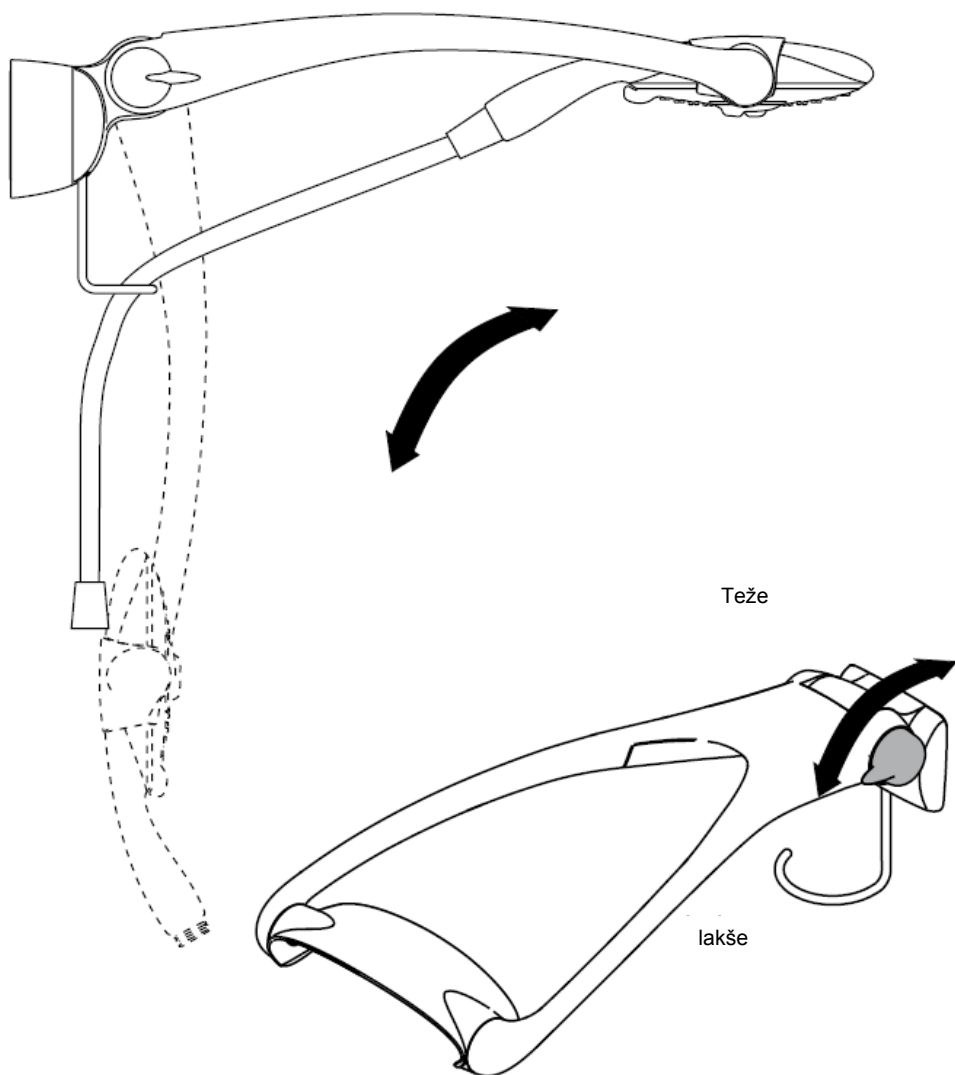

Čišćenje

Rubit® - ručni sustav za čišćenje omogućuje jednostavnim trljanjem odstranjivanje kamenca sa rupica prskalice tuša.

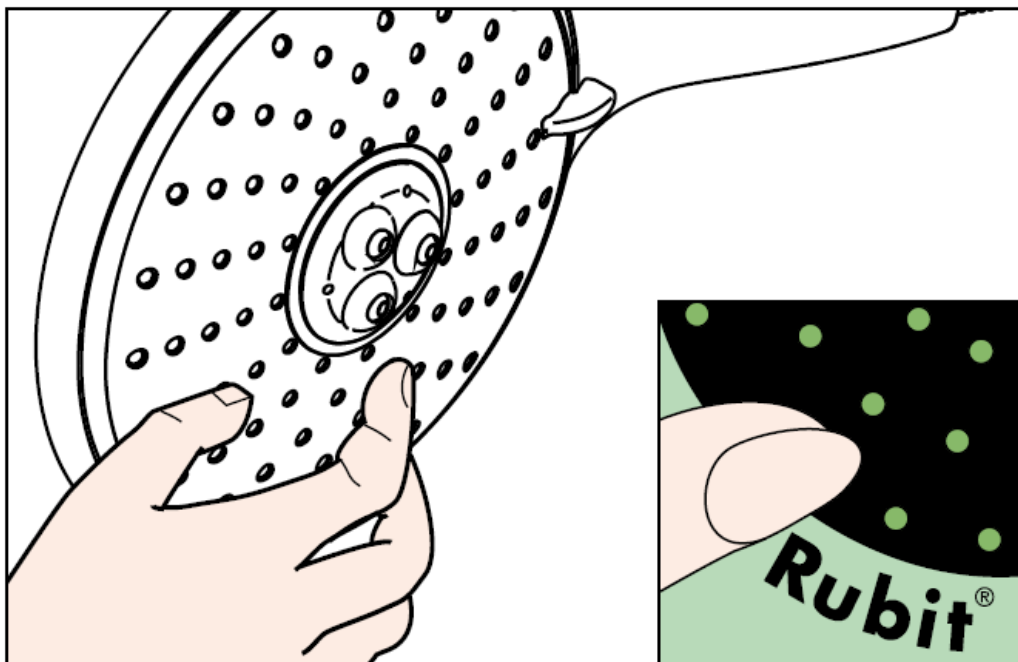

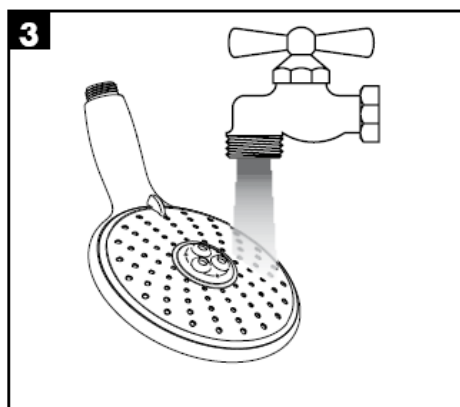
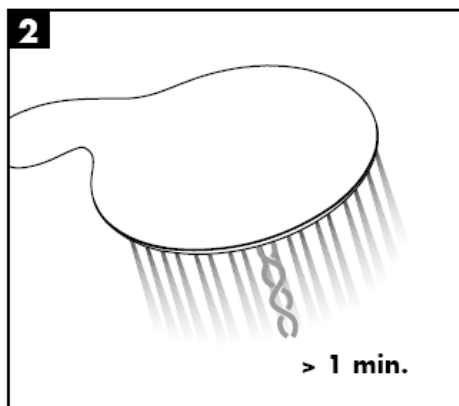
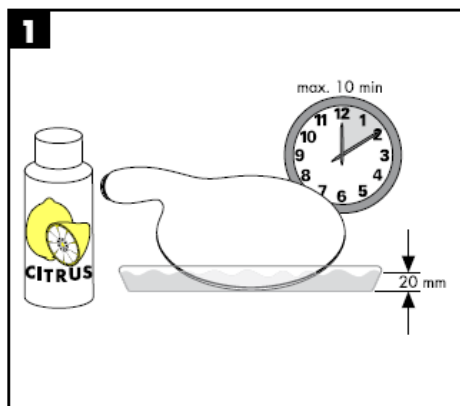

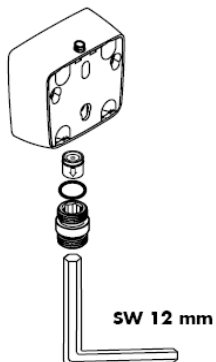

Pažnja!

Nepovratni ventil se mora provjeravati jednom godišnje prema standardu DIN 1988

hansgrohe

Hansgrohe · Postfach 1145 · D-77761 Schiltach · Telefon +49 (0) 78 36/51-1282 · Telefax +49 (0) 7836/511440
E-Mail: info@hansgrohe.com · Internet: www.hansgrohe.com

02/2008
9.06081.04
Hrvatski

Montaj kılavuzu

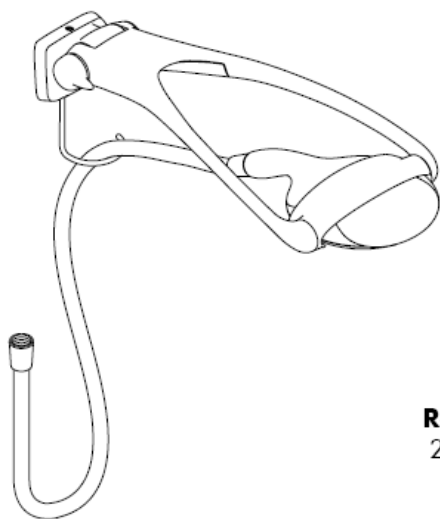

Raindance
28105000

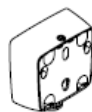

Raindance
28108000

Raindance Allrounder Set
28100000 / 28110000

hansgrohe

Raindance Allrounder Set

28100000 / 28110000

Classification acoustique et débit 28110000: ACS

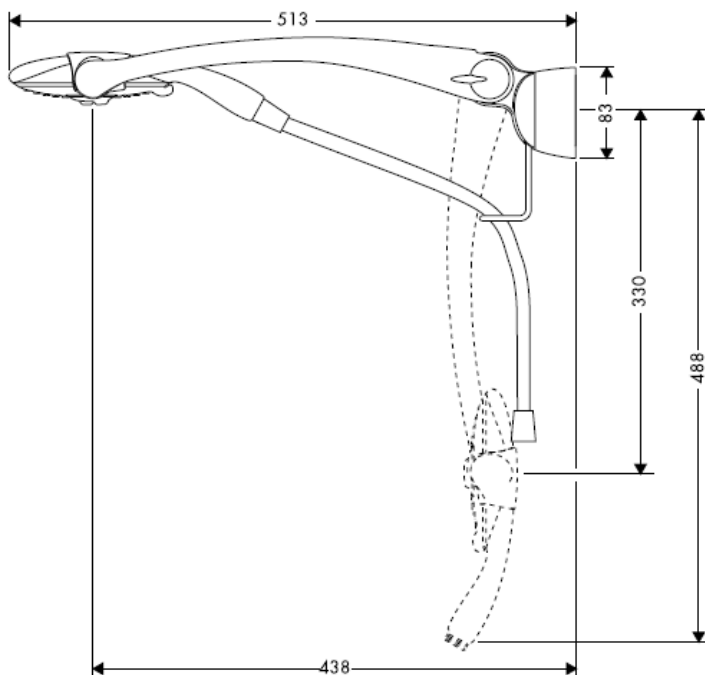

Raindance Eckmontage Set

28105000



Raindance UP-Adapter für Schlauchanschluß

28108000



Raindance Allrounder Set

28100000 / 28110000

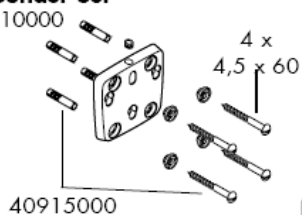

98562000

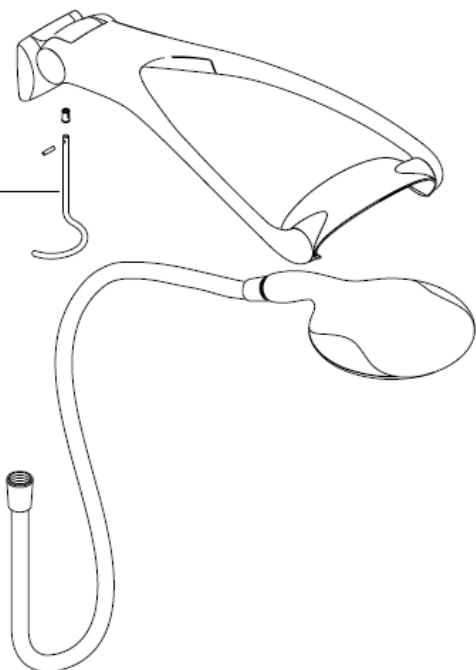

Raindance Eckmontage Set

28105000

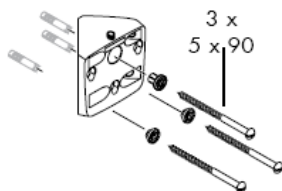

Raindance UP-Adapter für Schlauchanschluss

28108000

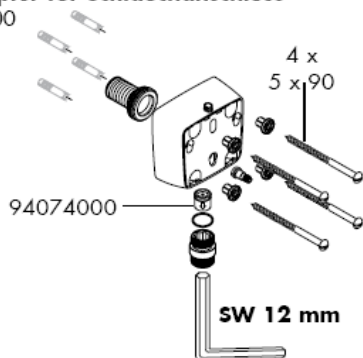

Montajı

El duşunun norm debisini sağlamak ve şebekeden kir gelmesini önlemek için, ekteki filtre adaptörü (A) takılmalıdır. Daha büyük bir su debisi istenirse, filtre adaptörünün (A) yerine bir süzgeç contası (B) takılmalıdır. Şebekeden gelen kirler çalışmayı etkileyebilir ve/veya el duşundaki fonksiyon parçalarının zarar görmesine neden olabilir; bu nedenle oluşan hasarlar için Hansgrohe hiçbir sorumluluk üstlenmez.

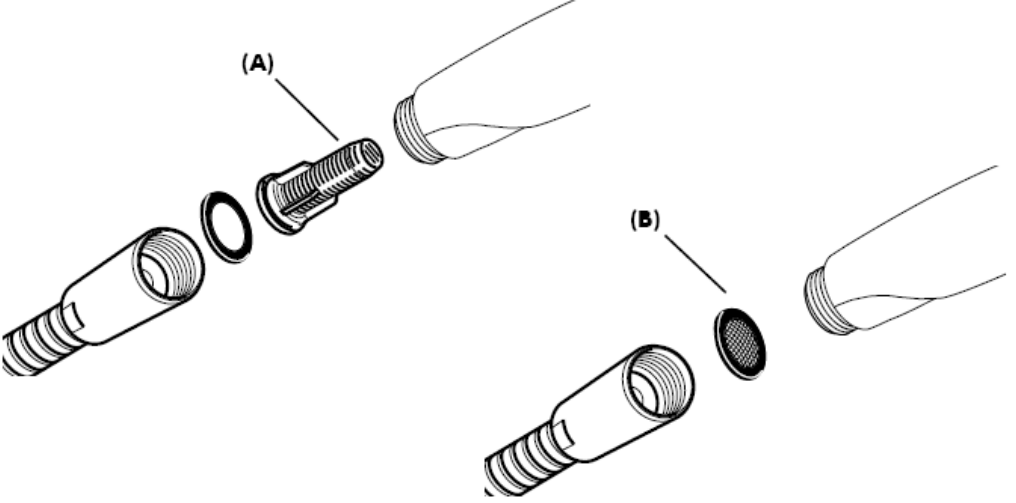

281000000

Filtre adaptörlü (A)

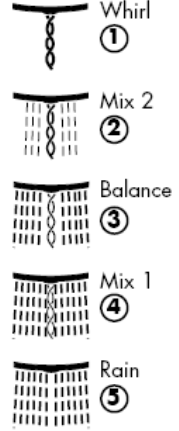
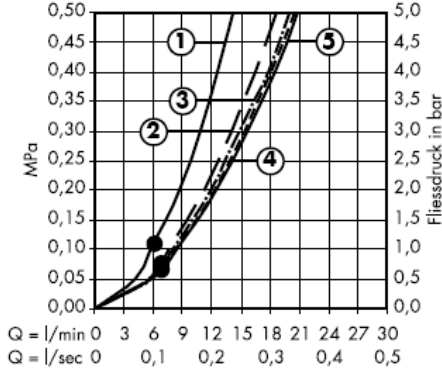

Süzgeç contalı (B)

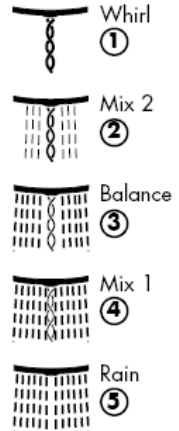
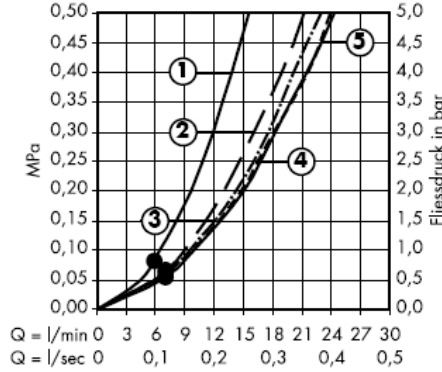

•'den itibaren fonksiyon garanti edilmiştir.

Filtre adaptörlü (A)

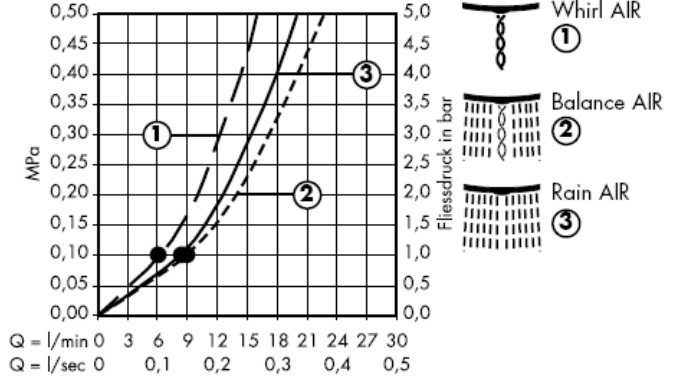

Süzgeç contalı (B)

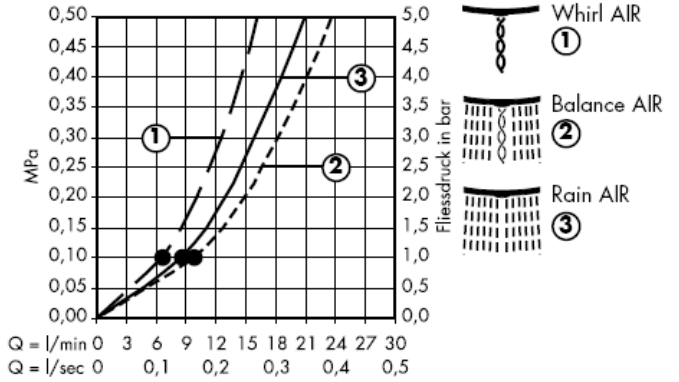

*den itibaren fonksiyon garanti edilmiştir.

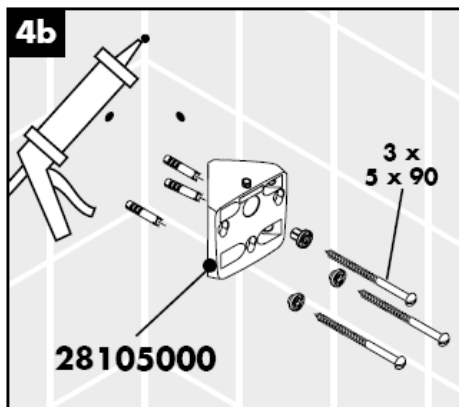
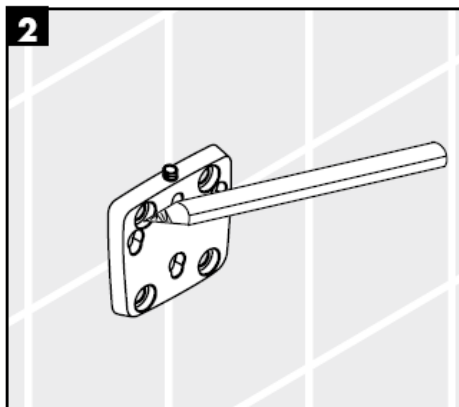
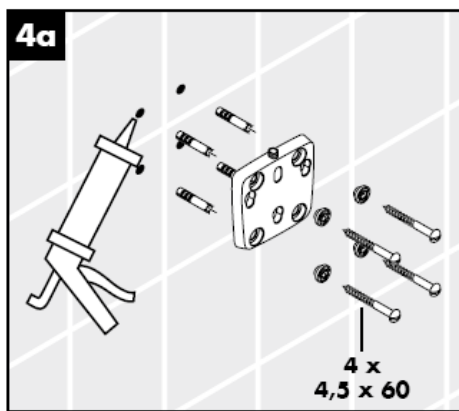
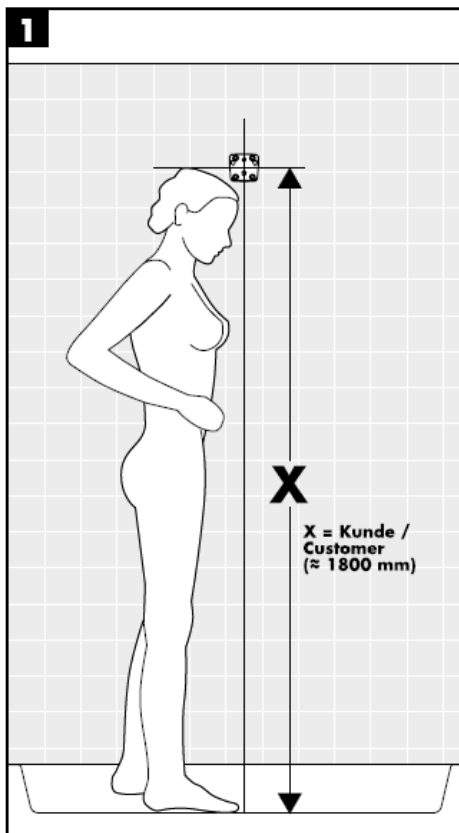



Eksantrik burç ile delik toleransları dengelenebilir.

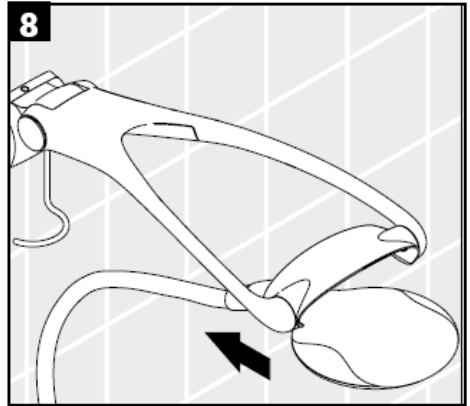
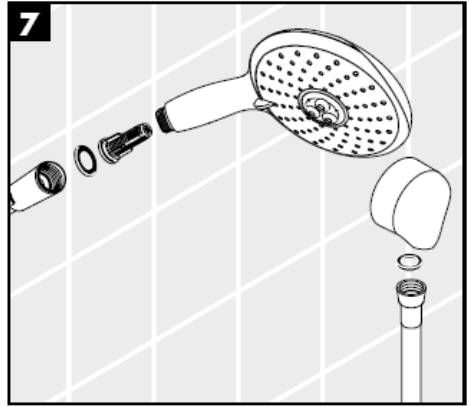
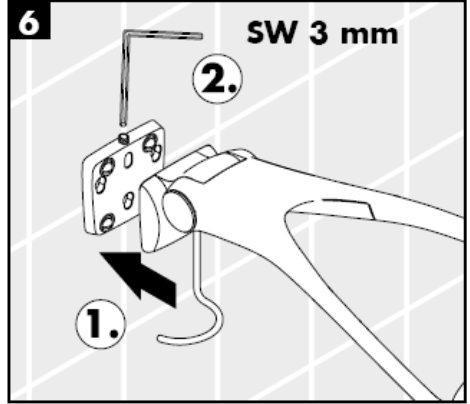

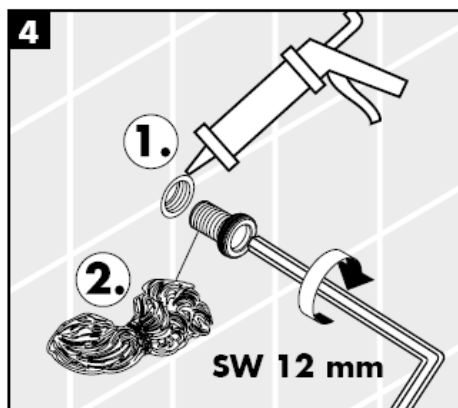
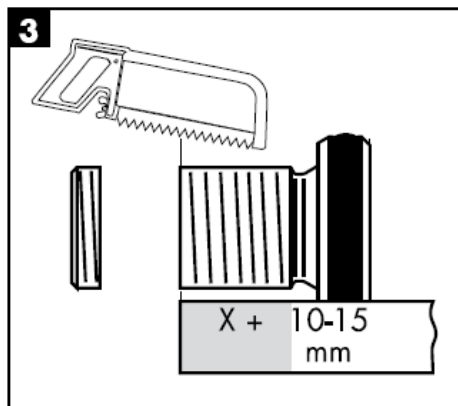
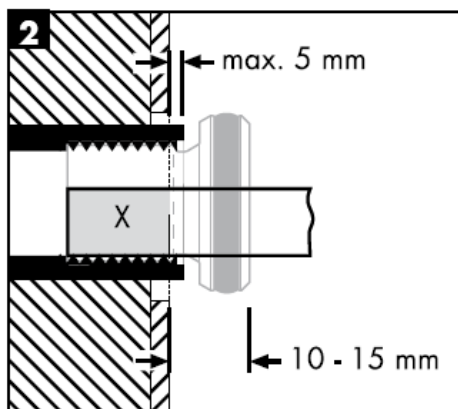
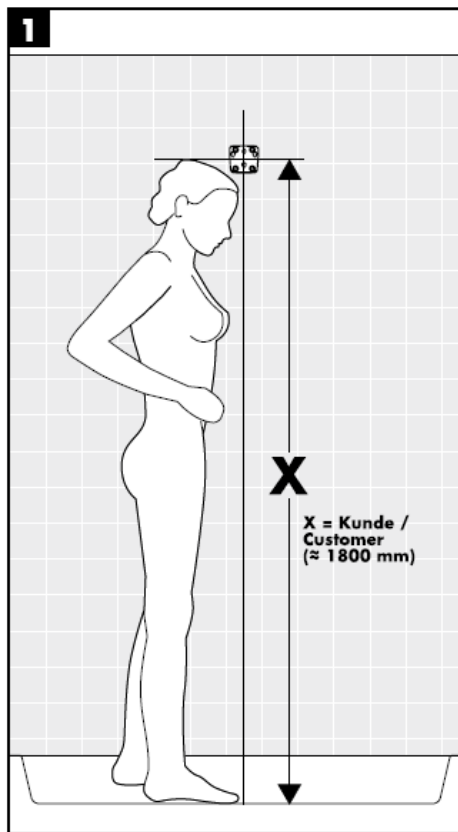

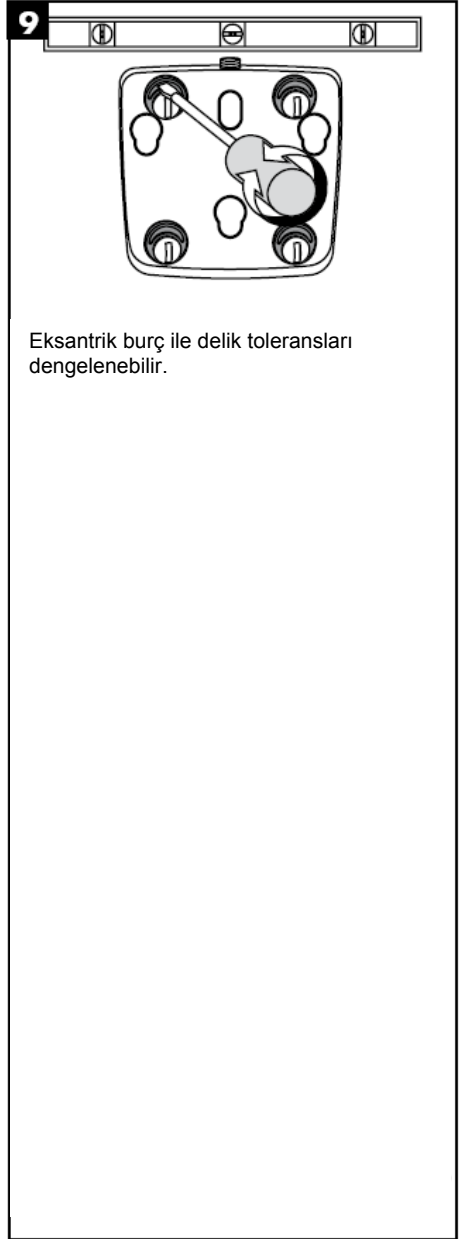
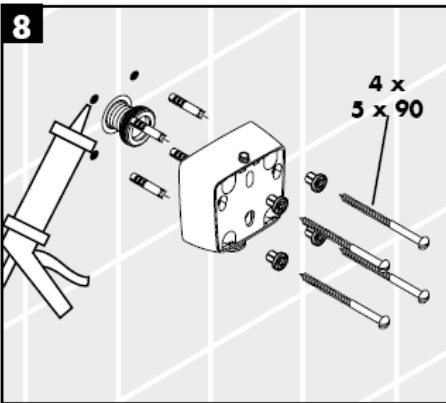
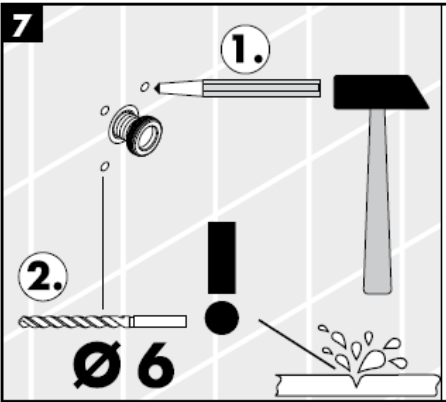
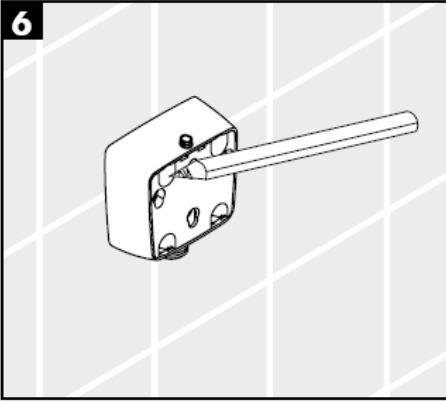



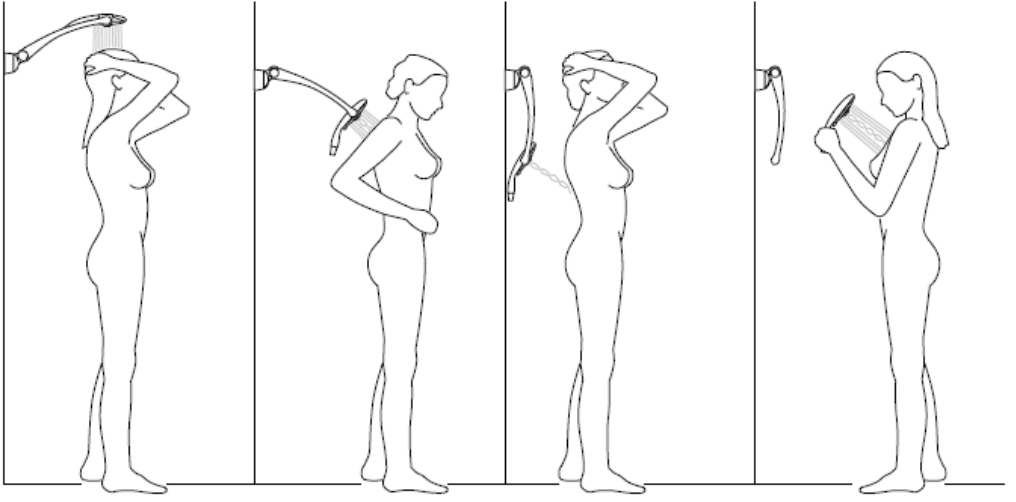

Çok amaçlı set, çok fonksiyonlu bir duş sistemidir. Kol konumuna bağlı olarak baş ya da yan duş fonksiyonu ya da ayrı el duşu kullanılabilir.

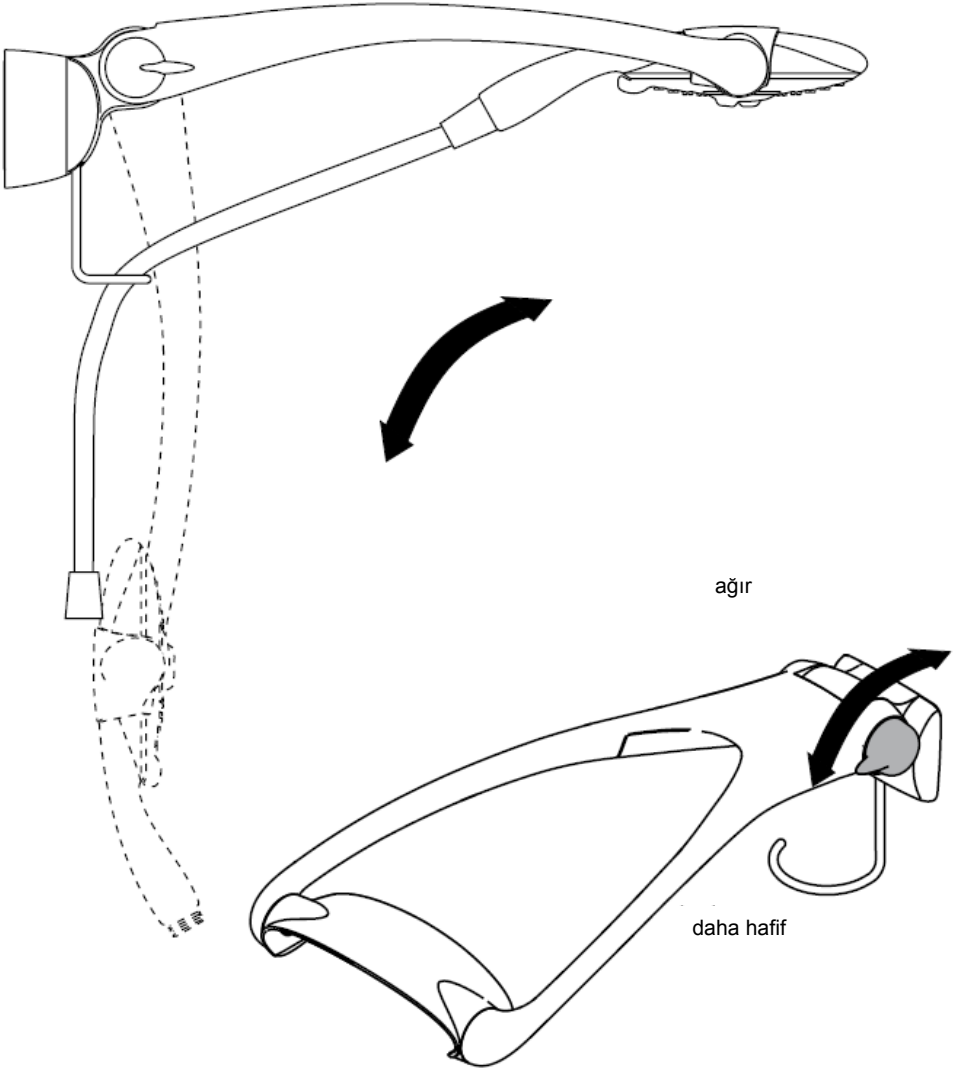

Temizleme

Rubit®, üründe bulunan bir temizleme fonksiyonudur. Basit bir ovuşturma ile sprey modüllerdeki kireci çözer.

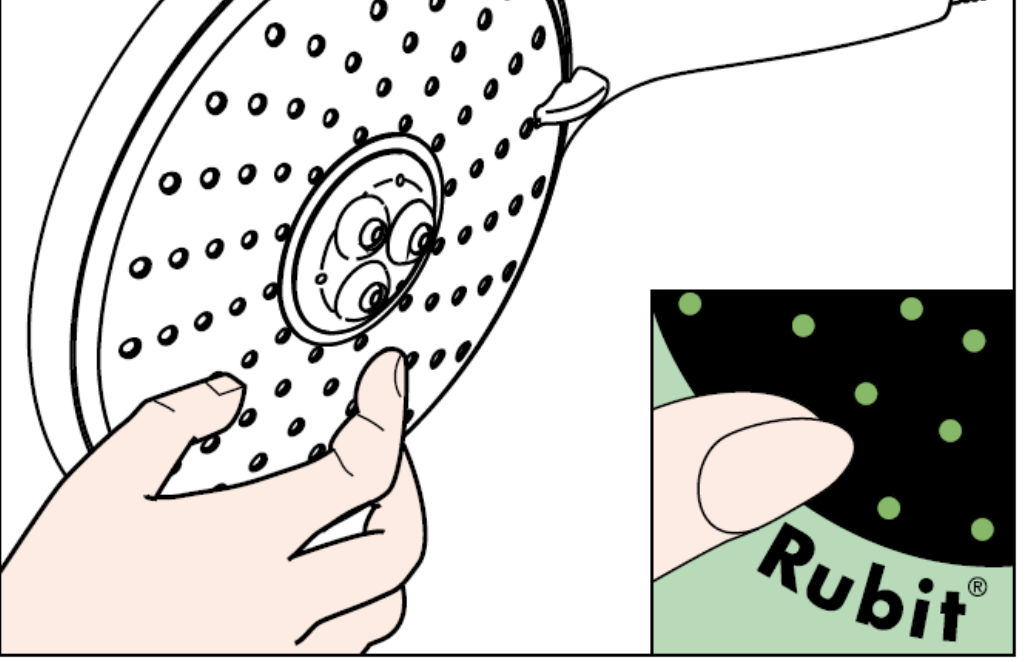

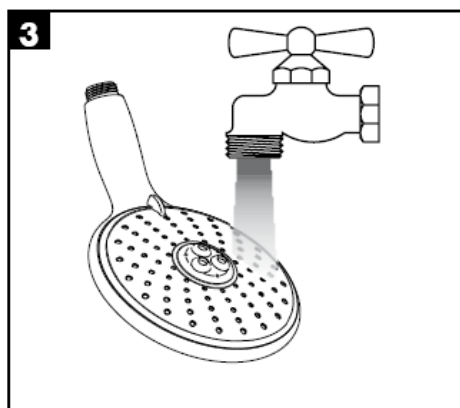
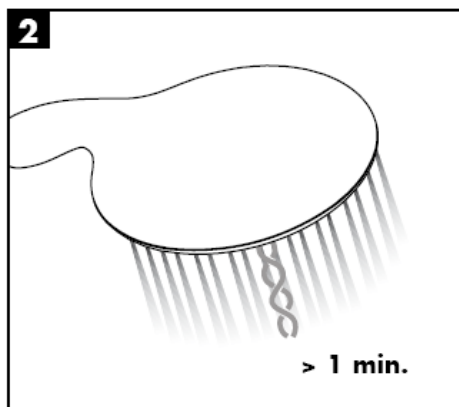
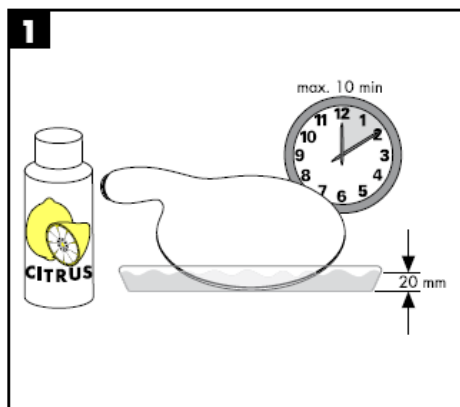

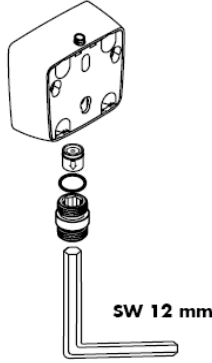

Önemli!

Çek valflara DIN 1988'e göre yılda bir kez çalışma kontrolü yapılmalıdır.

hansgrohe

Hansgrohe · Postfach 1145 · D-77761 Schiltach · Telefon +49 (0) 78 36/51-1282 · Telefax +49 (0) 7836/511440
E-Mail: info@hansgrohe.com · Internet: www.hansgrohe.com

02/2008
9.06081.04
Türkçe

Instrucțiuni de montare

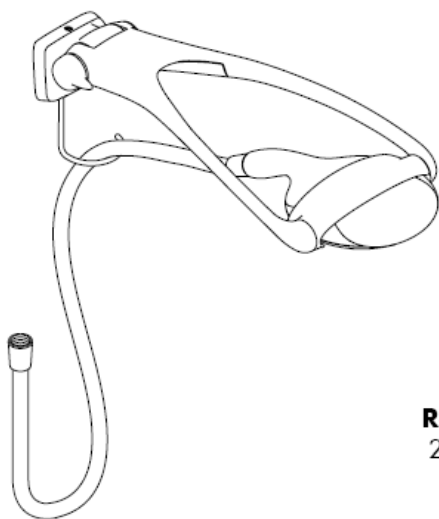

Raindance
28105000

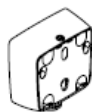

Raindance
28108000

Raindance Allrounder Set
28100000 / 28110000

hansgrohe

Raindance Allrounder Set

28100000 / 28110000

Classification acoustique et débit 28110000: ACS

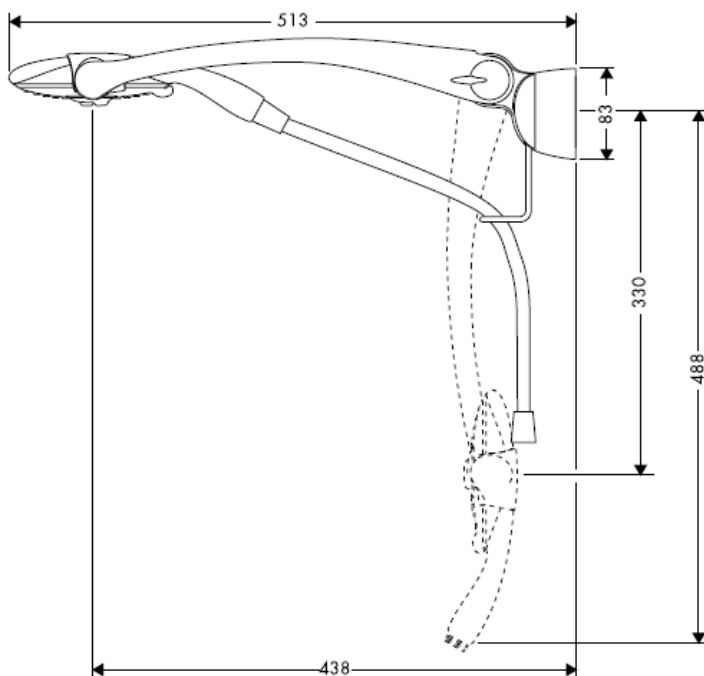

Raindance Eckmontage Set

28105000



Raindance UP-Adapter für Schlauchanschluß

28108000



Raindance Allrounder Set

28100000 / 28110000

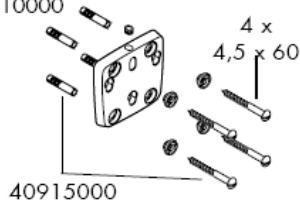

98562000

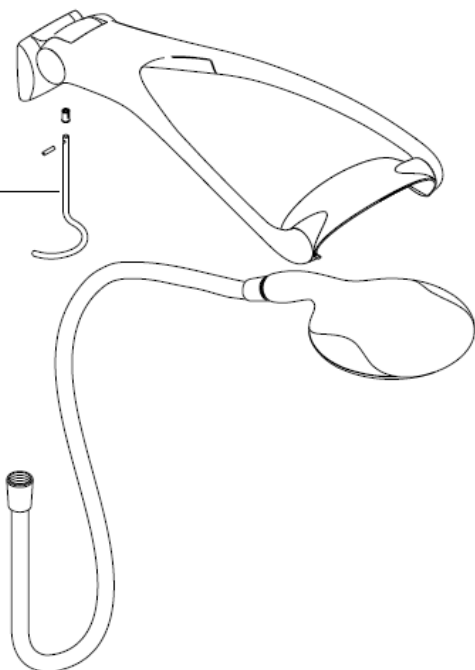

Raindance Eckmontage Set

28105000

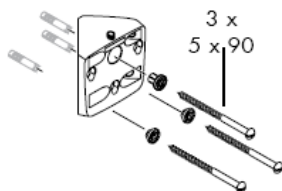

Raindance UP-Adapter für Schlauchanschluss

28108000

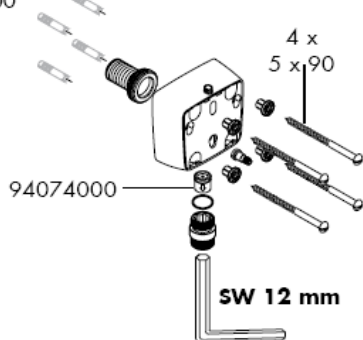

Montare

Montați garnitura de filtru (A) livrată cu aparatul pentru asigurarea funcționării corespunzătoare a dușului de mână și pentru evitarea pătrunderii impurităților din rețeaua de apă. Dacă doriți un debit mai mare de apă, montați garnitura sită (B) în locul garniturii de filtru (A).

Impuritățile pătrunse pot influența funcționarea dușului de mână și/sau deteriora componentele acestuia, garanția nu acoperă daunele provocate din această cauză.

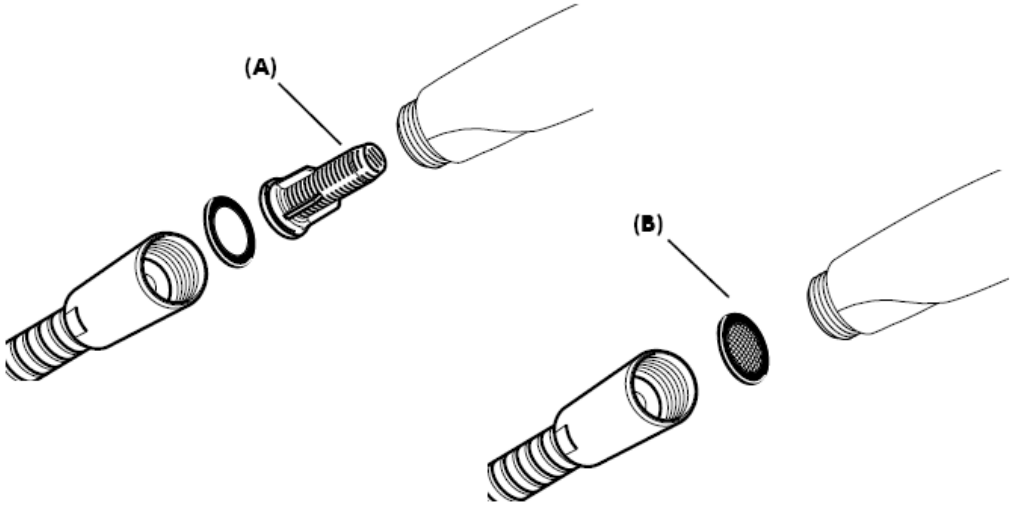

Cu garnitură de filtru (A)

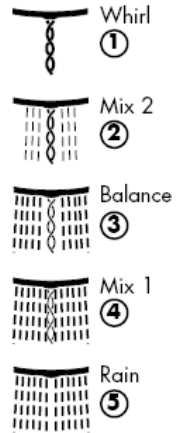
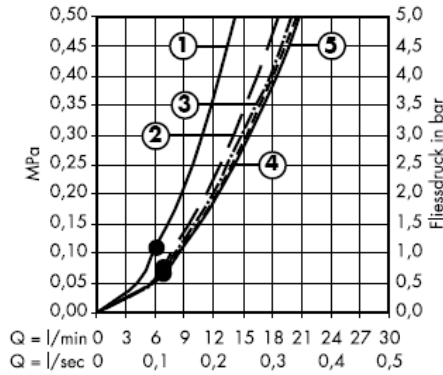

Cu garnitură de filtru (B)

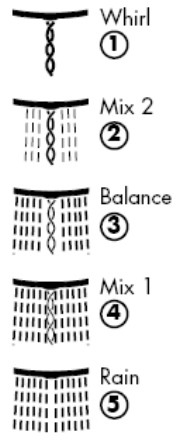
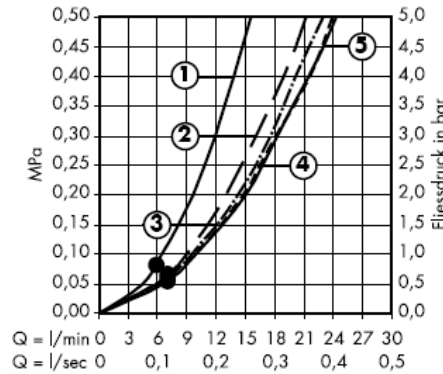

Începând de la • funcționarea este garantată.

Cu garnitură de filtru (A)

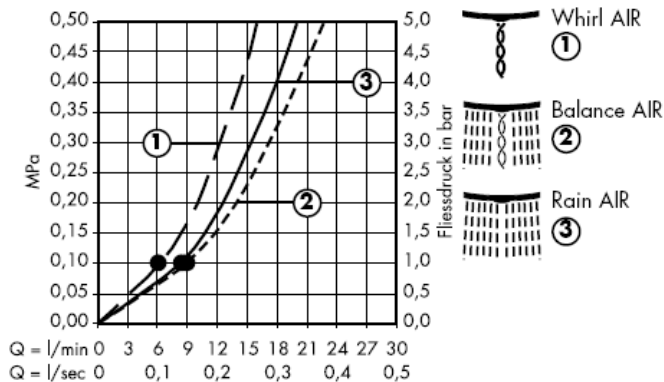

Cu garnitură de filtru (B)

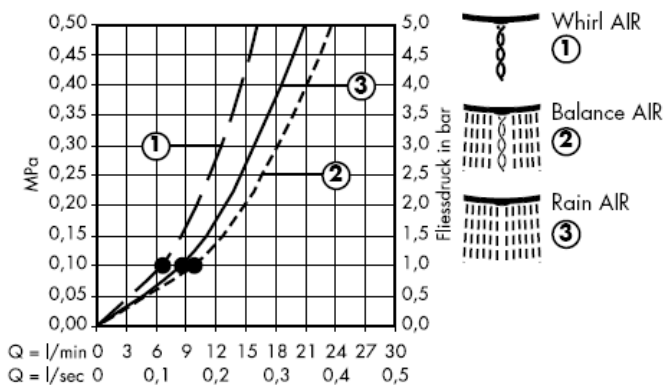

Începând de la • funcționarea este garantată.

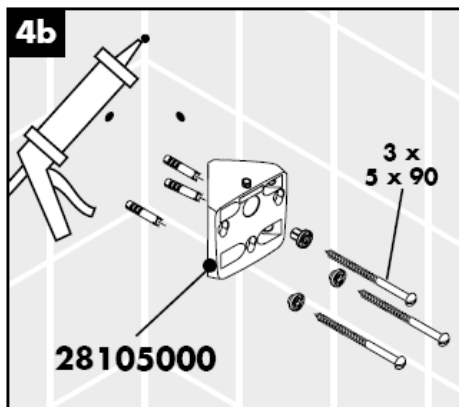
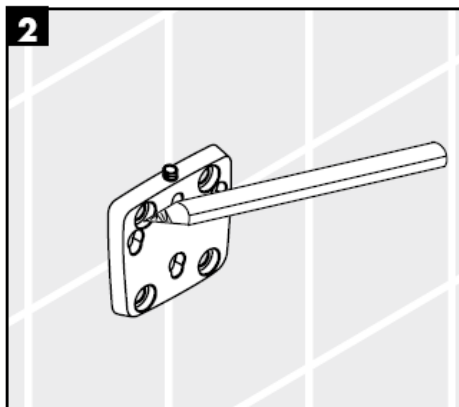

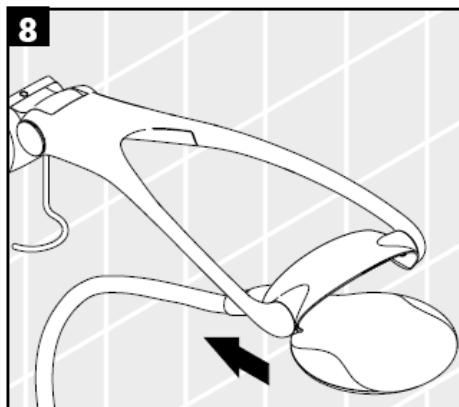
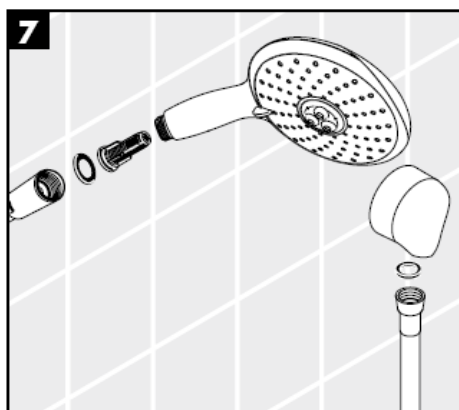
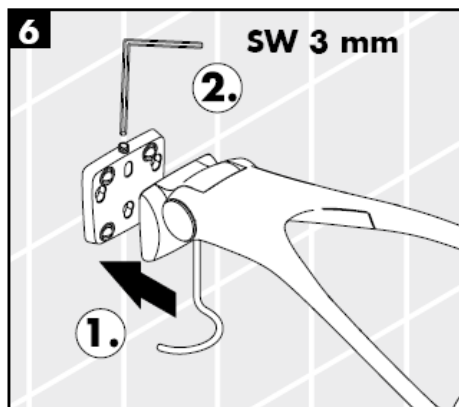
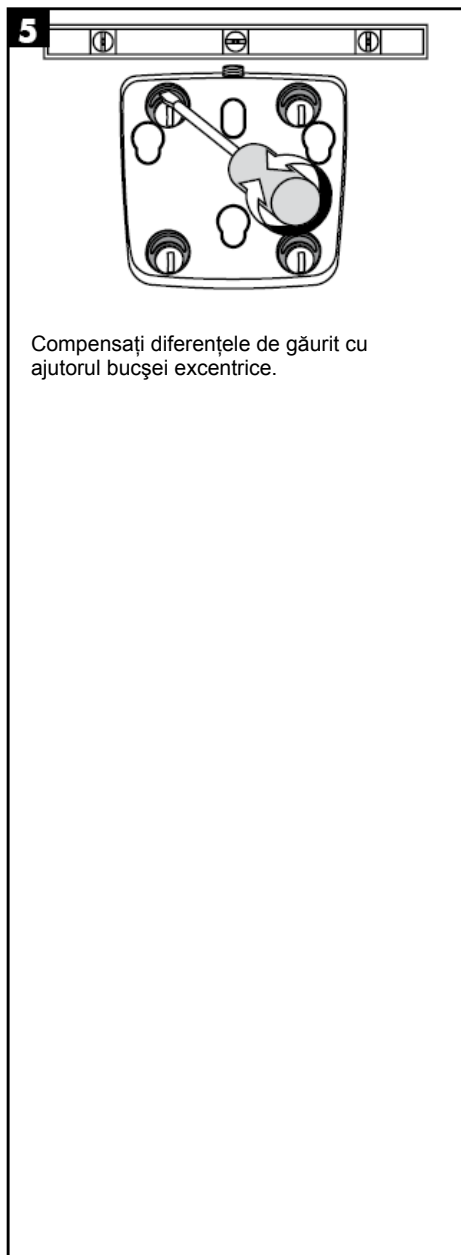

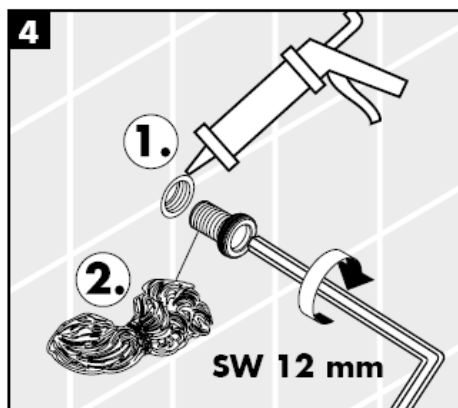
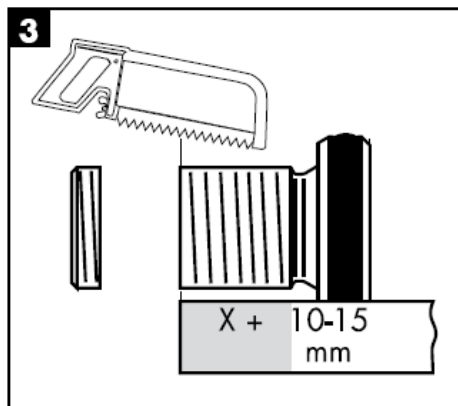
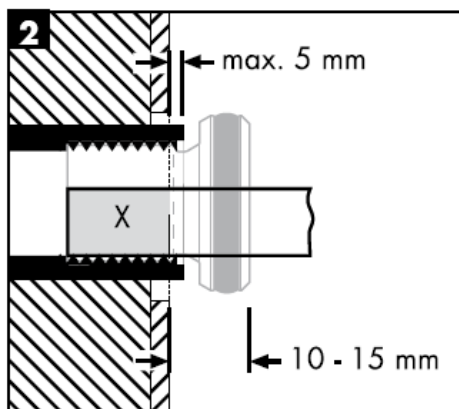
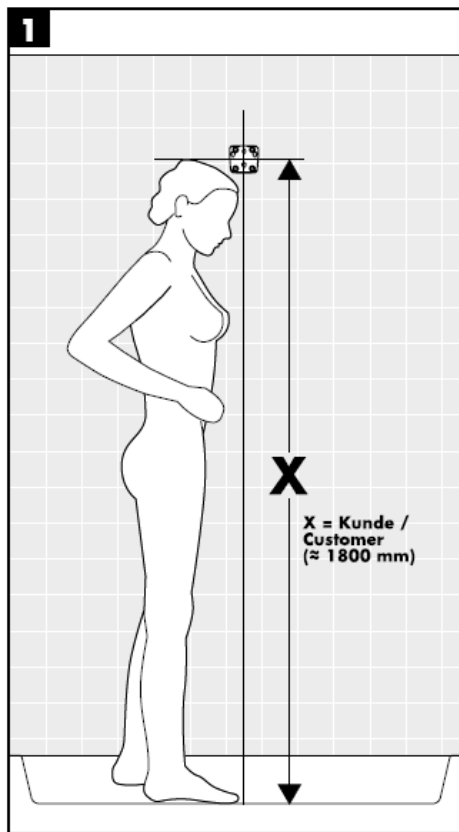

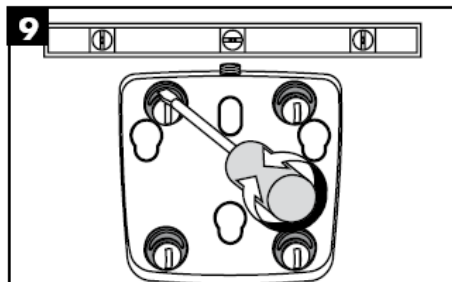
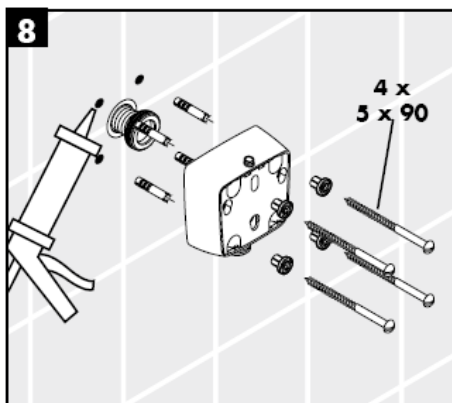
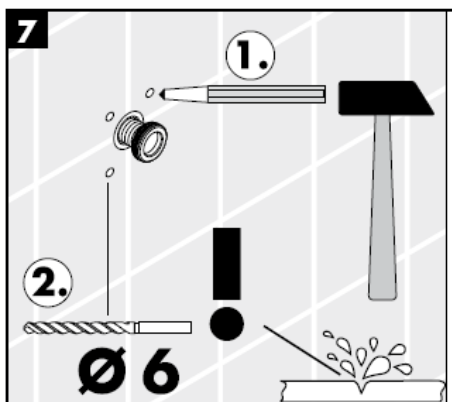
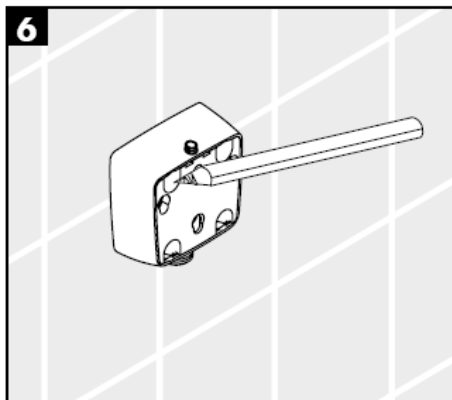

Compensați diferențele de găurit cu ajutorul buçsei excentrice.

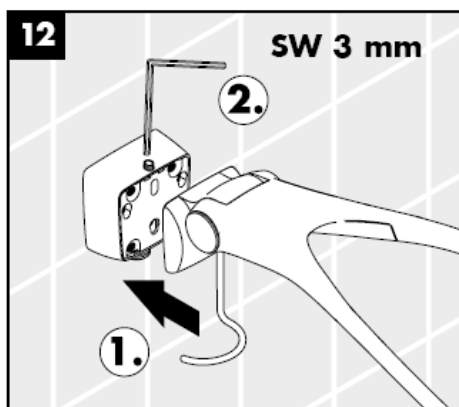
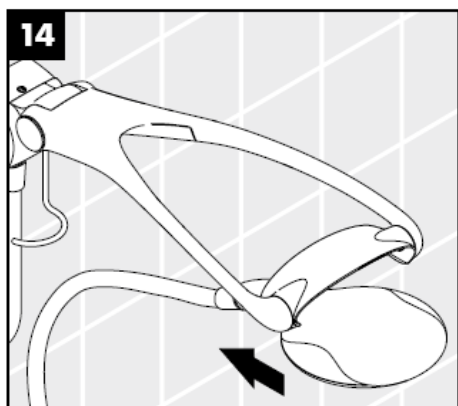
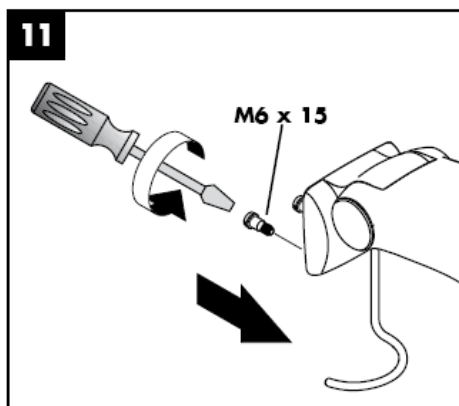
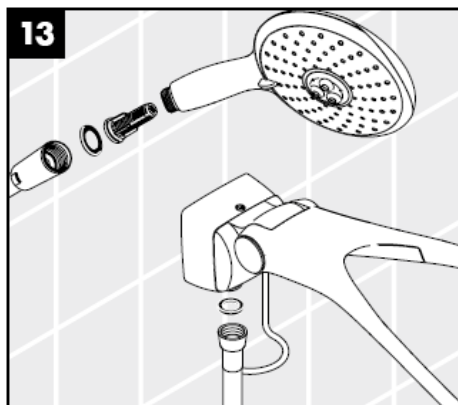
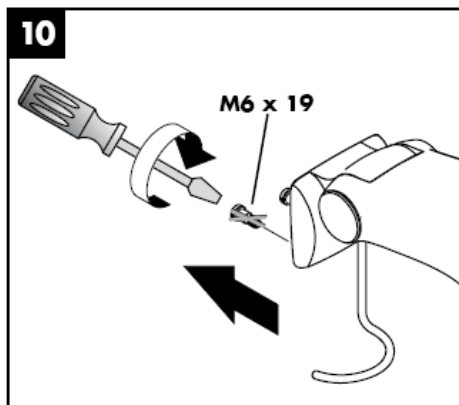



Setul Allrounder este un set de duș multifuncțional. Permite folosirea atât a unui duș lateral cât și a dușului din tavan și a dușului de mână.

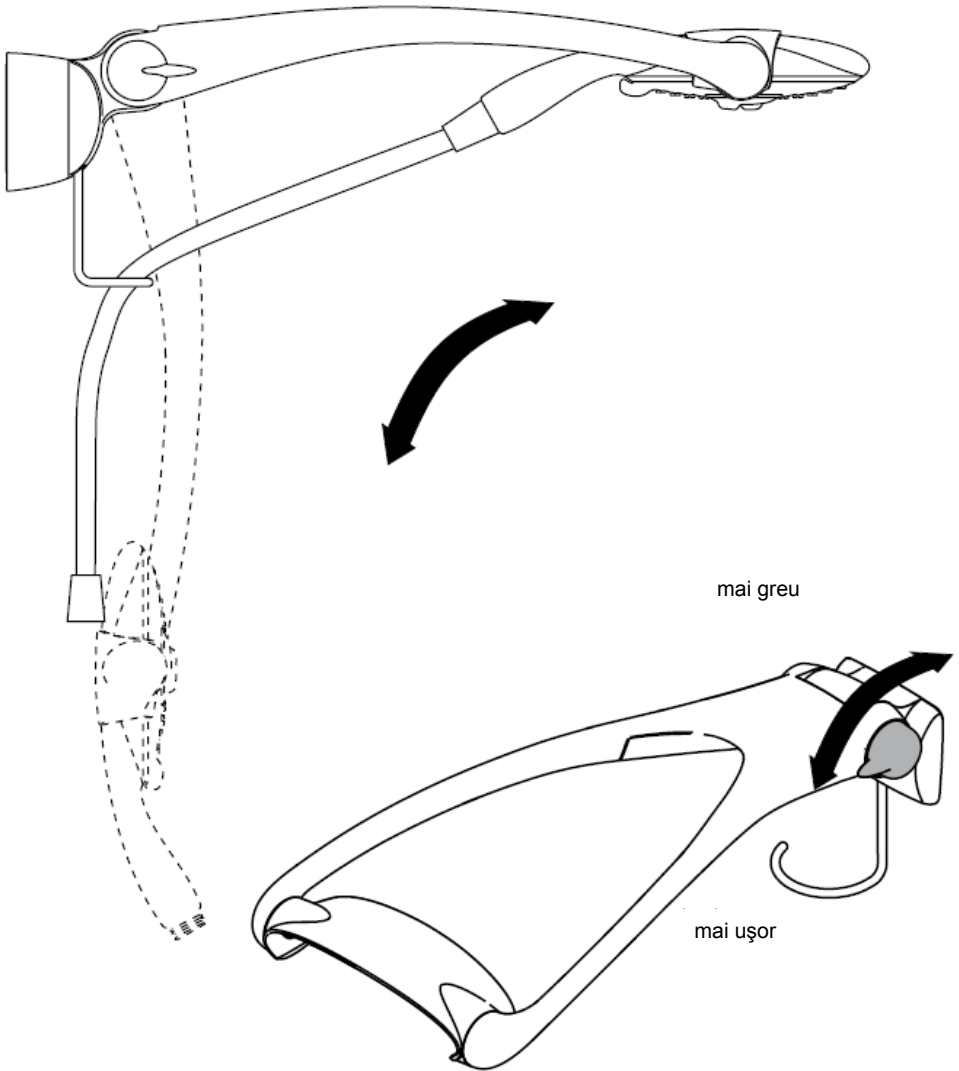

Curățare

Cu ajutorul sistemului Rubit® puteți să îndepărtați depunerile de calcar de pe diferitele duze de jet de apă prin frecare.

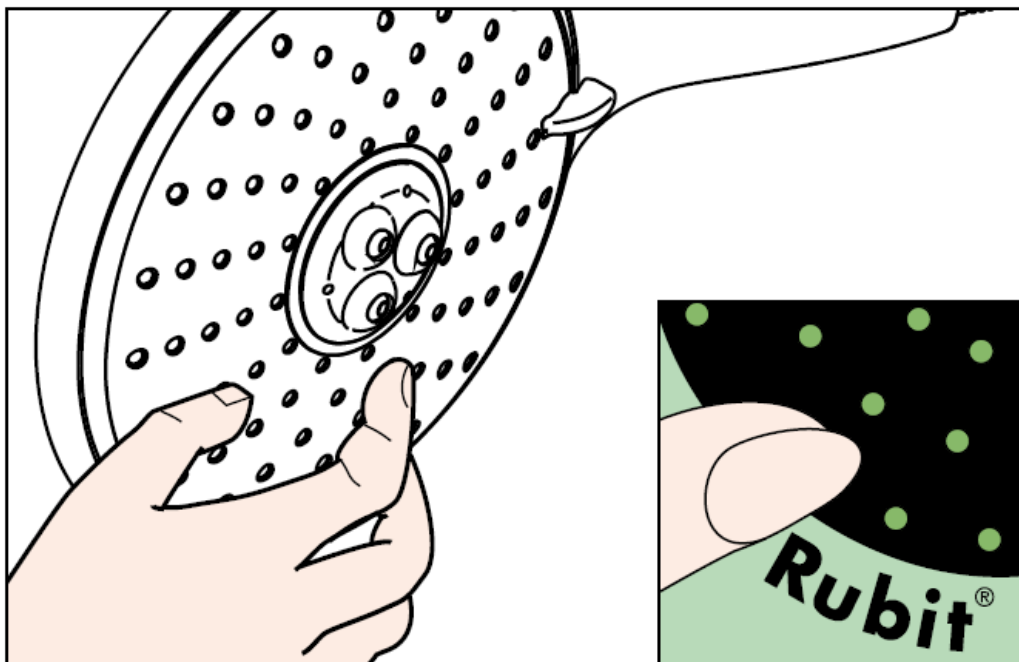

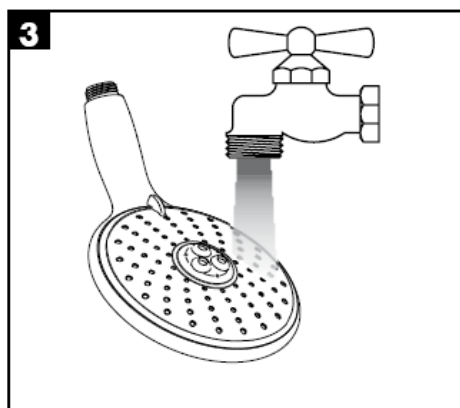
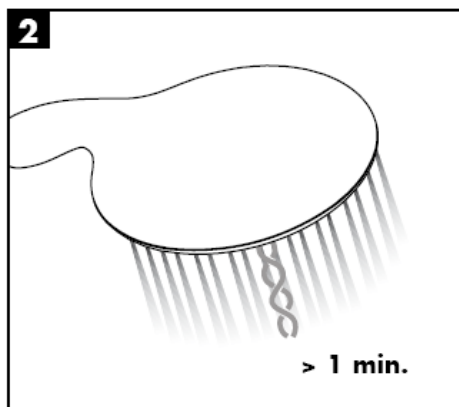
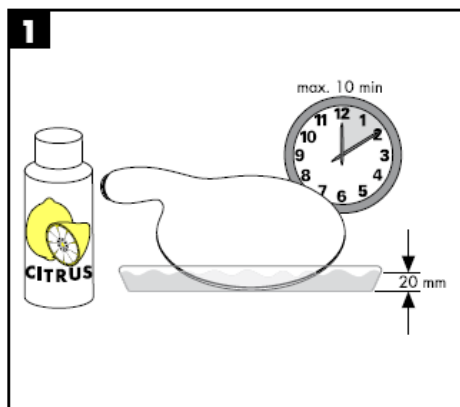

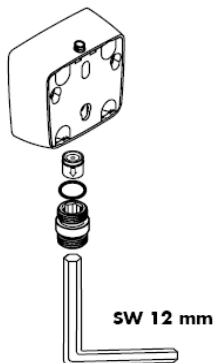

Atenție!

Supapele antiretur trebuie verificate anual conform DIN 1988.

hansgrohe

Hansgrohe · Postfach 1145 · D-77761 Schiltach · Telefon +49 (0) 78 36/51-1282 · Telefax +49 (0) 7836/511440
E-Mail: info@hansgrohe.com · Internet: www.hansgrohe.com

02/2008
9.06081.04
România

Οδηγία συναρμολόγησης

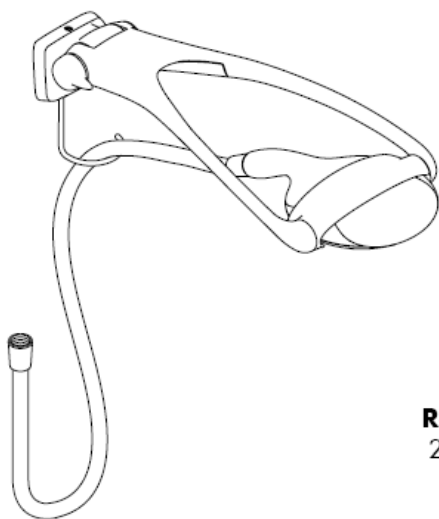

Raindance
28105000

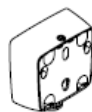

Raindance
28108000

Raindance Allrounder Set
28100000 / 28110000

hansgrohe

Raindance Allrounder Set

28100000 / 28110000

Classification acoustique et débit 28110000: ACS

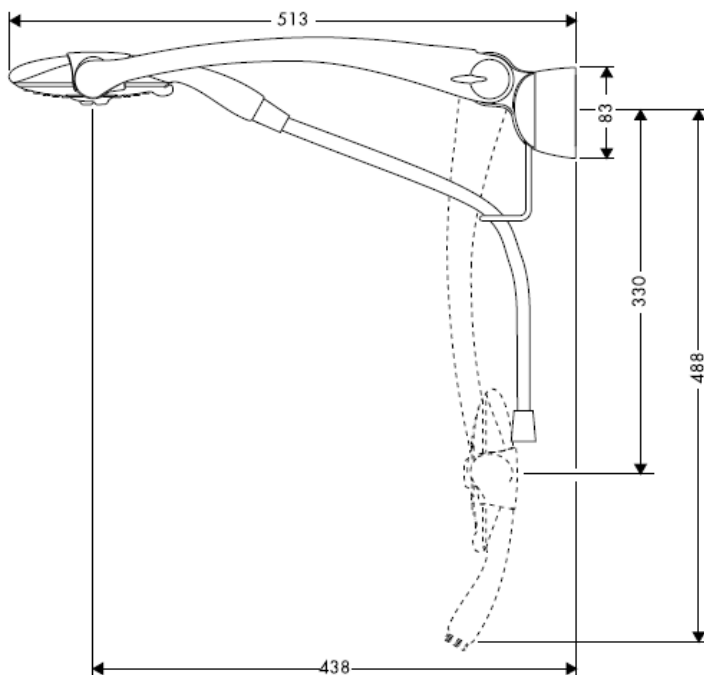

Raindance Eckmontage Set

28105000



Raindance UP-Adapter für Schlauchanschluß

28108000



Raindance Allrounder Set

28100000 / 28110000

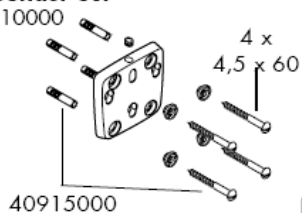

98562000

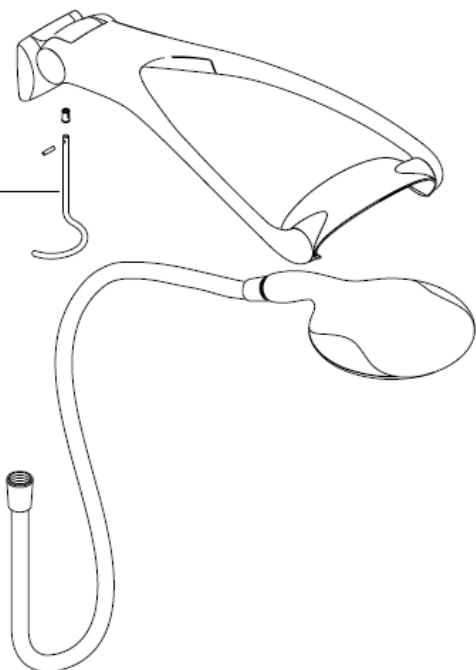

Raindance Eckmontage Set

28105000

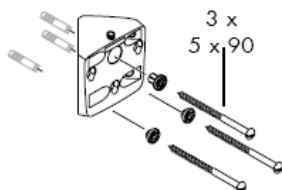

Raindance UP-Adapter für Schlauchanschluss

28108000

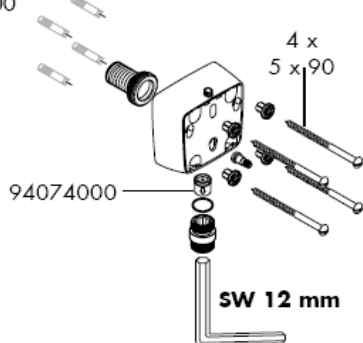

Συναρμολόγηση

Η συνοδευτική προσθήκη φίλτρου (A) πρέπει να εγκατασταθεί, προκειμένου να διασφαλίσει την κανονική ροή του καταιονιστήρα χειρός και να αποτρέψει την είσοδο ρύπων από το δίκτυο ύδρευσης. Εάν είναι επιθυμητή μία μεγαλύτερη ροή νερού, θα πρέπει, στη θέση της προσθήκης φίλτρου (A) να τοποθετηθεί το στεγανοποιητικό παρέμβυσμα (B). Η είσοδος ρύπων μπορεί να επηρεάσει δυσμενώς τη λειτουργία ή/και να προκαλέσει βλάβες στα λειτουργικά σημεία του καταιονιστήρα χειρός, για τις οποίες ζημιές δεν αναλαμβάνει καμία ευθύνη η εταιρεία Hansgrohe.

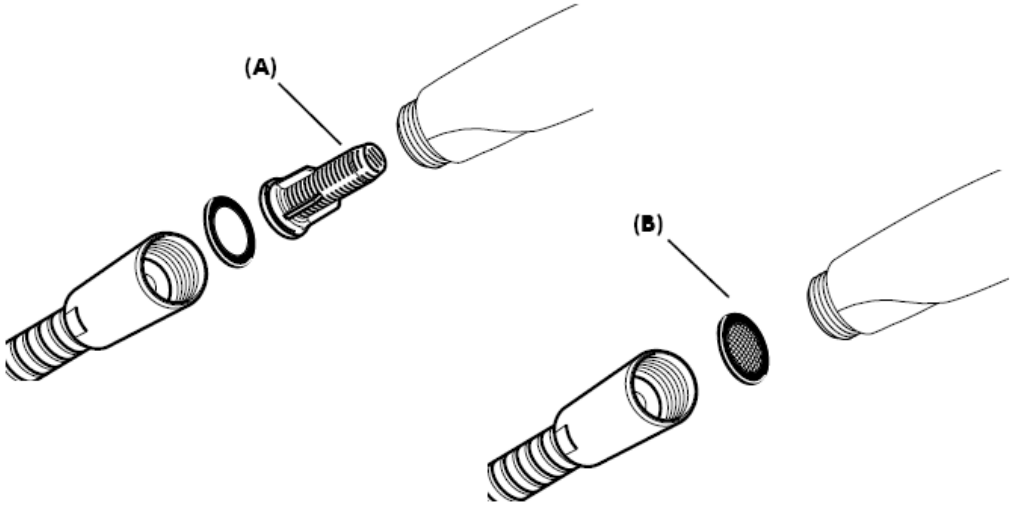

Με προσθήκη φίλτρου (A)

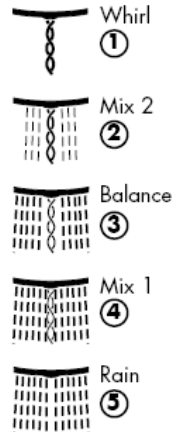
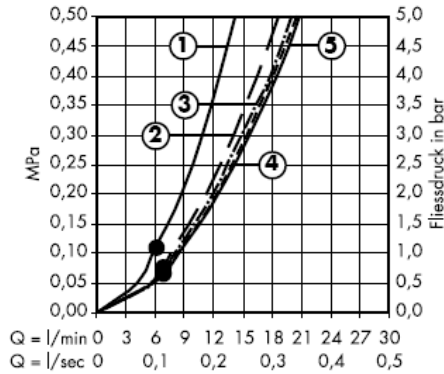

Με στεγανοποιητικό φίλτρο (B)

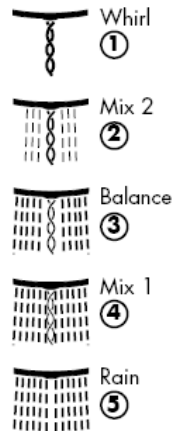
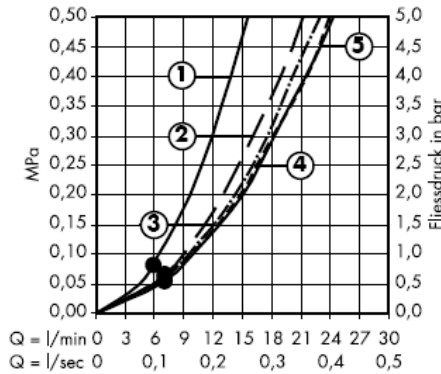

Αυτή η λειτουργία διασφαλίζεται από το σημείο κι έπειτα

Με προσθήκη φίλτρου (Α)

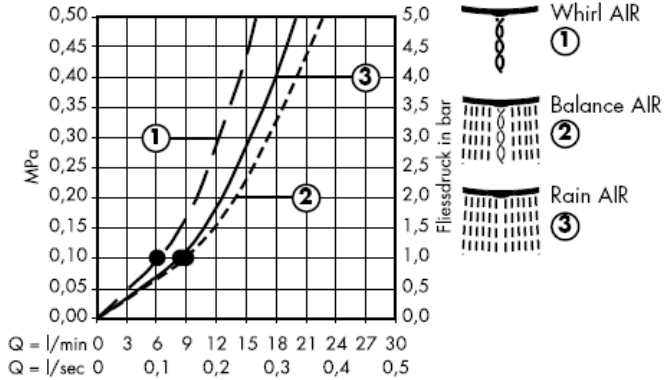

Με στεγανοποιητικό φίλτρο (Β)

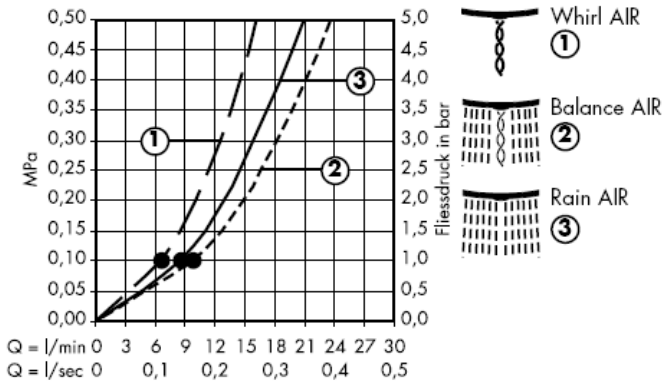

Αυτή η λειτουργία διασφαλίζεται από το σημείο κι έπειτα

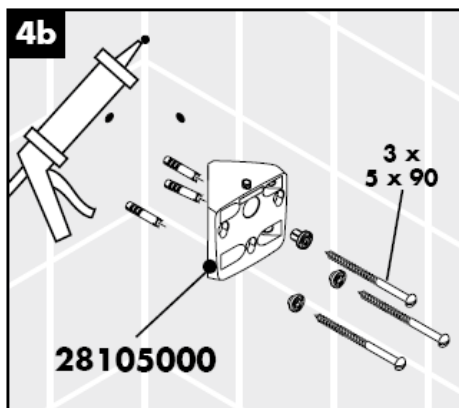
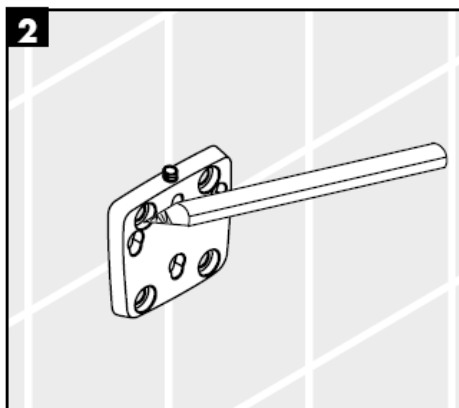

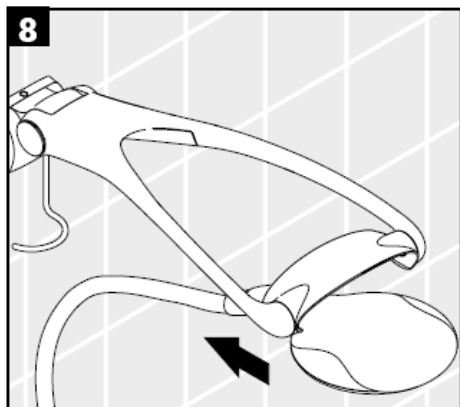
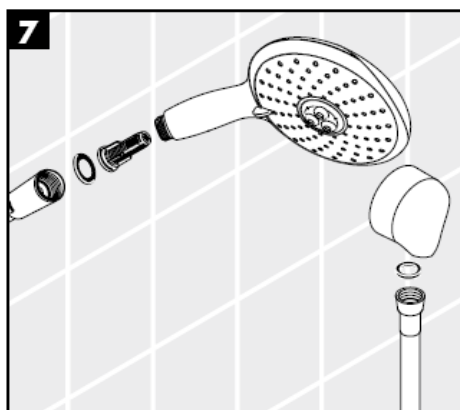
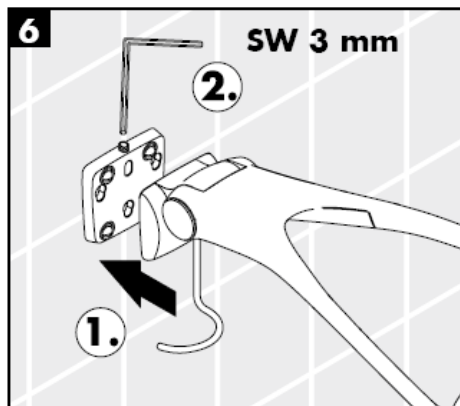
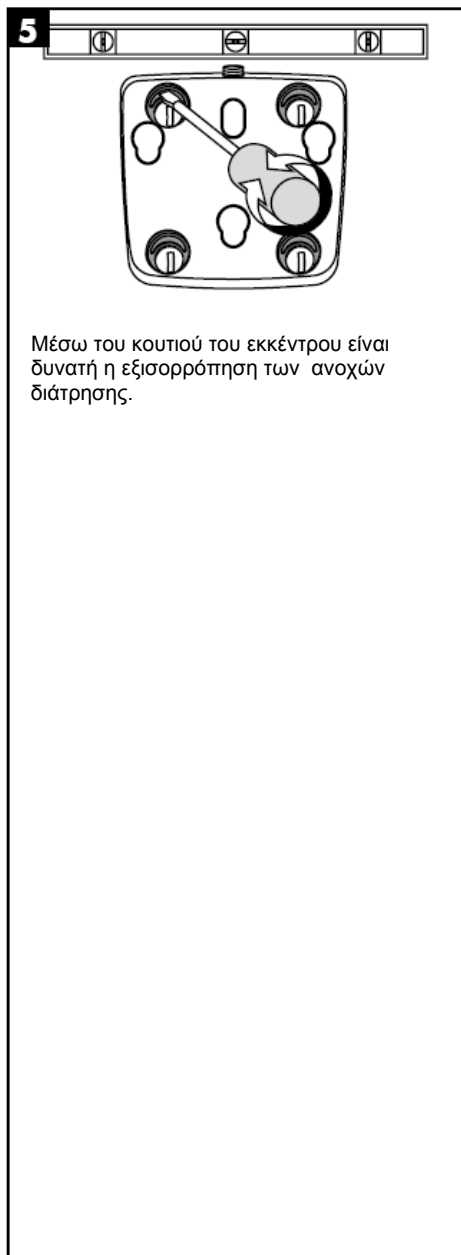

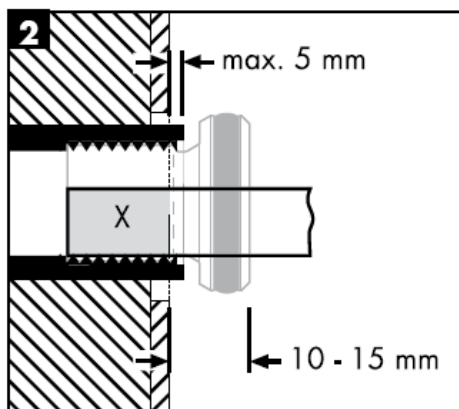
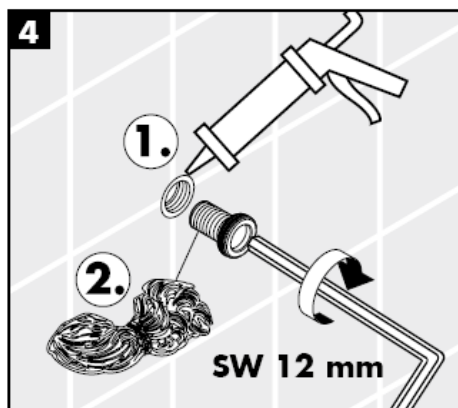
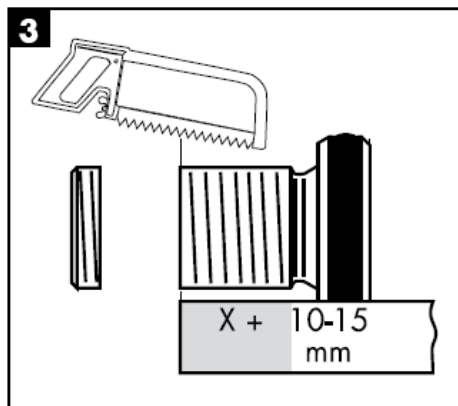
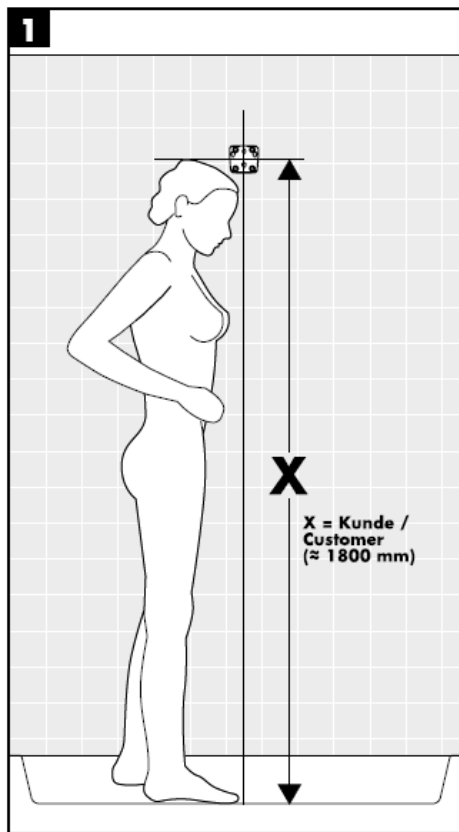

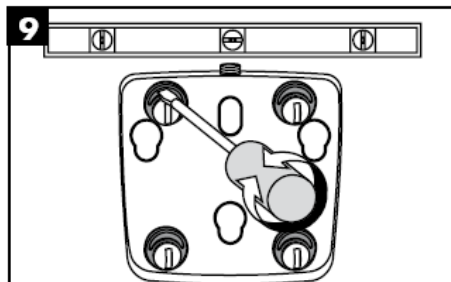
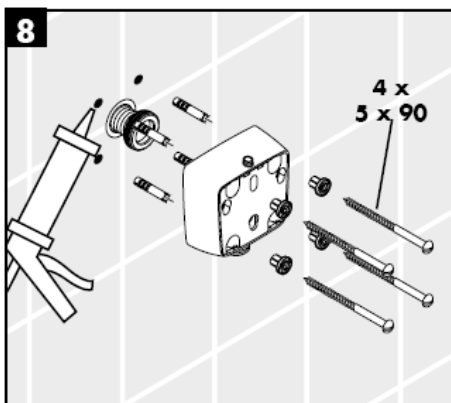
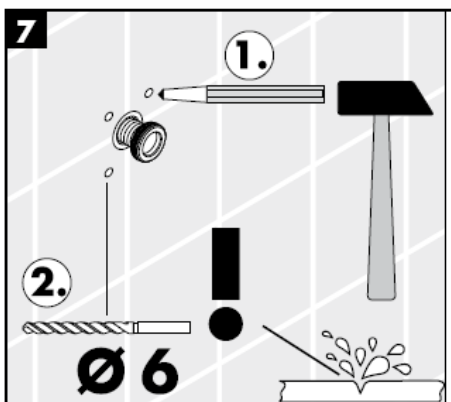
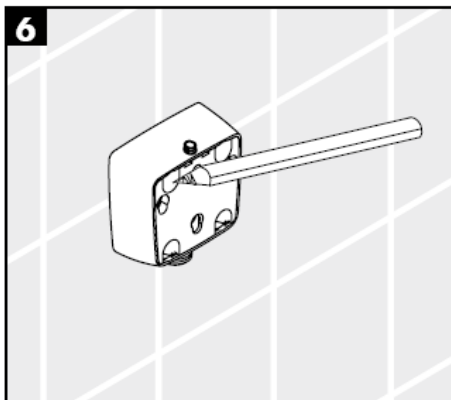

Μέσω του κουτιού του εκκέντρου είναι δυνατή η εξισορρόπηση των ανοχών διάτρησης.



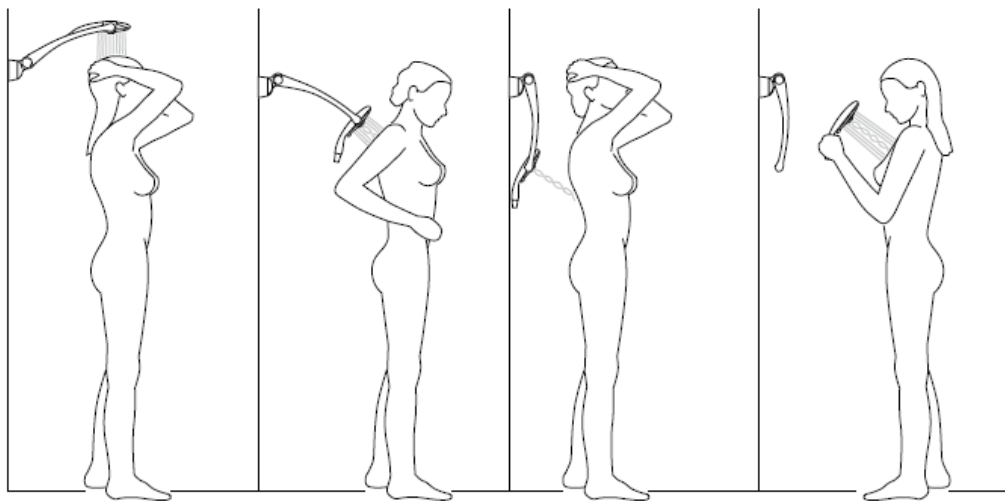

Το σετ Allrounder είναι ένα πολυλειτουργικό σύστημα καταιονισμού νερού. Ανάλογα με τη θέση του αναβολέα, είναι δυνατή η χρήση λειτουργιών καταιονισμού κεφαλής ή πλευρικών λειτουργιών καταιονισμού ή / και ξεχωριστών λειτουργιών του καταιονιστήρα χειρός.

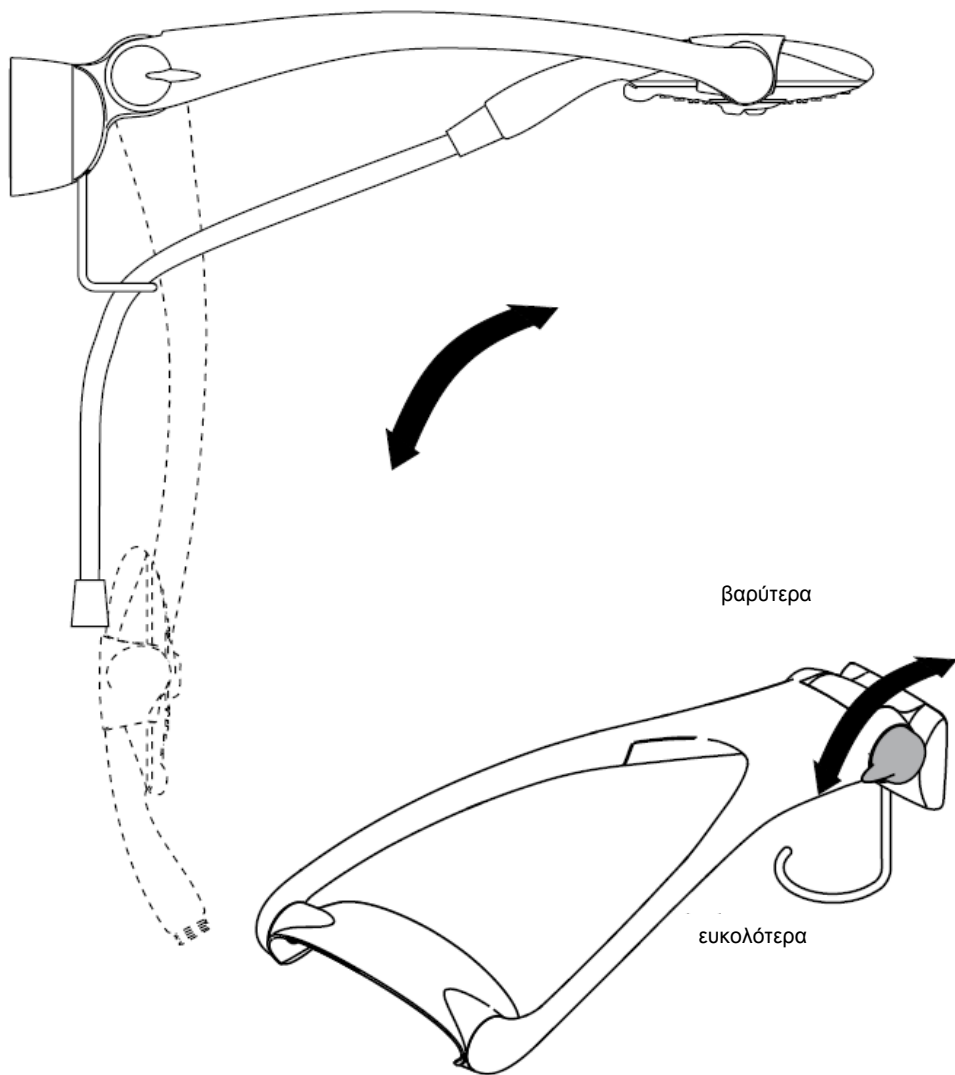

Καθαρισμός

Με Rubit®, τη λειτουργία καθαρισμού με το χέρι, μπορούν να απομακρυνθούν με απλό τρίψιμο τα άλατα από τα κανάλια του καταιονιστήρα.

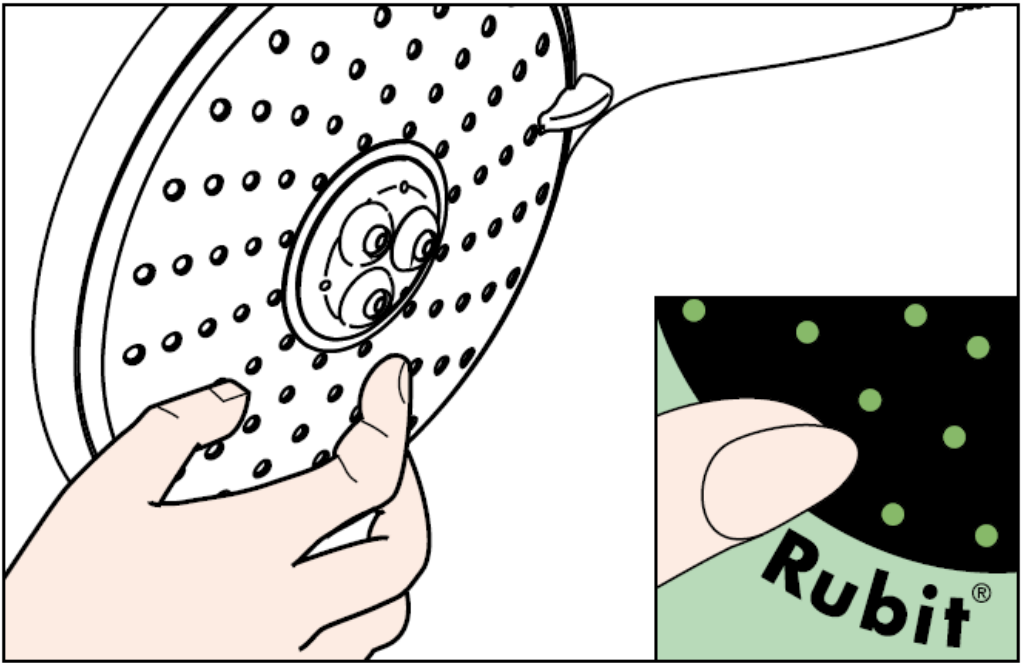

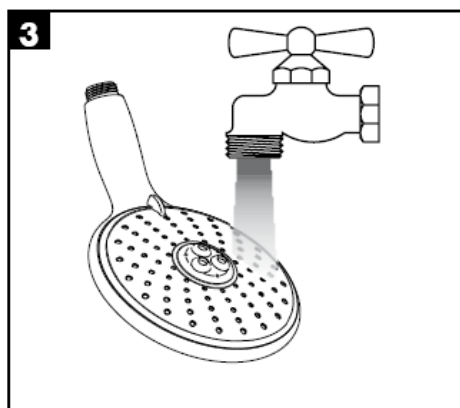
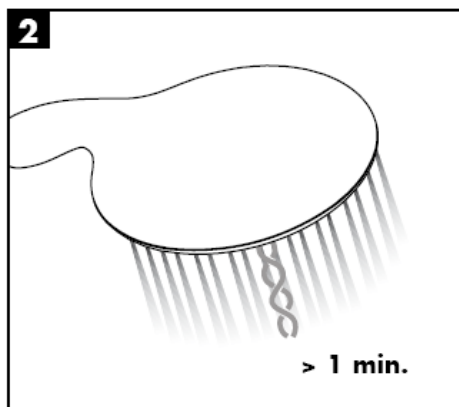
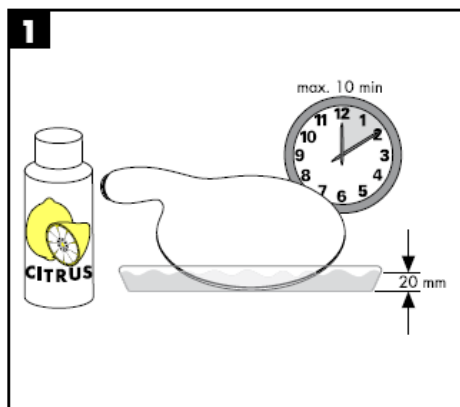

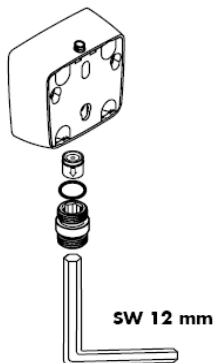

Προσοχή!

Οι βαλβίδες αντεπιστροφής πρέπει να ελέγχονται μια φορά το χρόνο ως προς τη λειτουργία τους, σύμφωνα με το πρότυπο DIN 1988.

hansgrohe

Hansgrohe · Postfach 1145 · D-77761 Schiltach · Telefon +49 (0) 78 36/51-1282 · Telefax +49 (0) 7836/511440
E-Mail: info@hansgrohe.com · Internet: www.hansgrohe.com

02/2008
9.06081.04
Ελληνικά

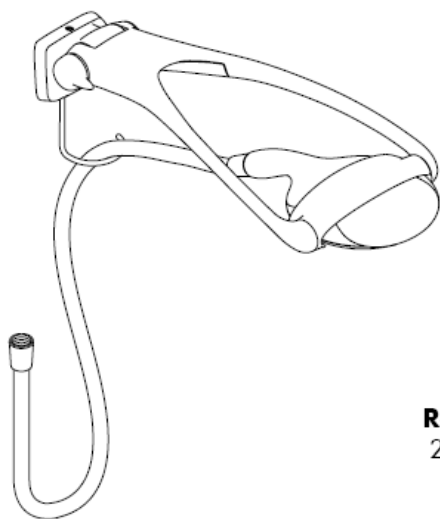

Raindance
28105000

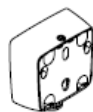

Raindance
28108000

Raindance Allrounder Set
28100000 / 28110000

hansgrohe

Raindance Allrounder Set

28100000 / 28110000

Classification acoustique et débit 28110000: ACS

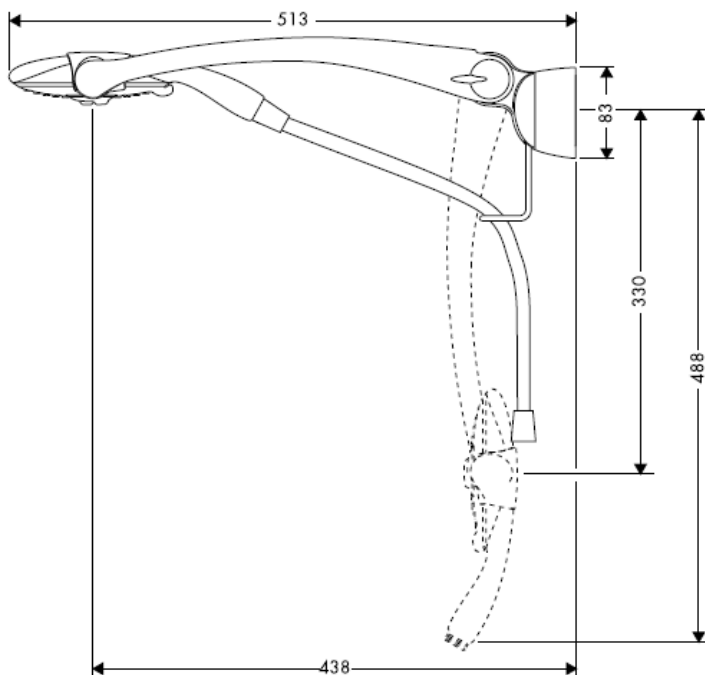

Raindance Eckmontage Set

28105000



Raindance UP-Adapter für Schlauchanschluß

28108000



Raindance Allrounder Set

28100000 / 28110000

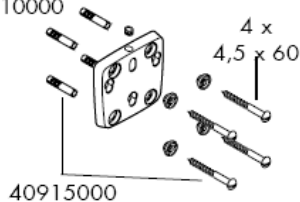

98562000

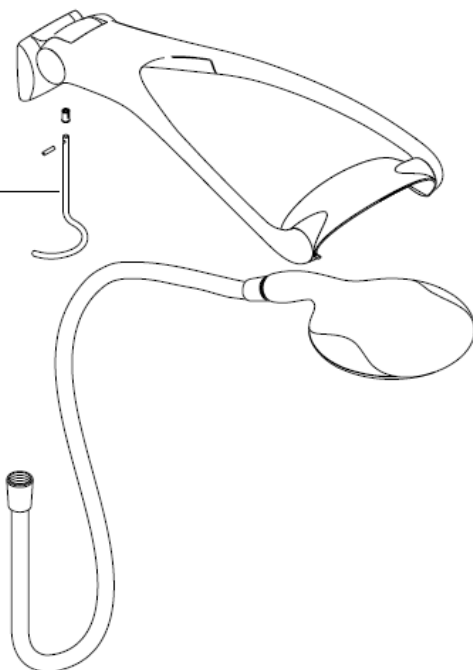

Raindance Eckmontage Set

28105000

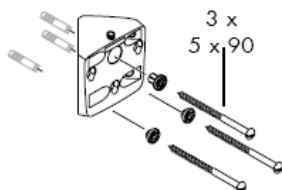

Raindance UP-Adapter für Schlauchanschluss

28108000

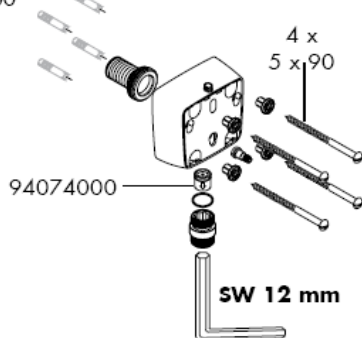

التركيب

يجب استخدام وليجة المرشح (A) لضمان الحصول على معدل التدفق القياسي وحماية الدش اليدوي من الأوساخ التي تحملها شبكة المواسير. هل تريد الحصول على معدل تدفق أعلى؟ إذن يجب أن تستخدم حشوية المرشح (B) بدلاً من وليجة المرشح (A). حيث تؤدي الأوساخ الواردة إلى حدوث أعطال أو / وقد تتسبب في تلف أجزاء من من الدش اليدوي، ومثل هذه الأعطال تلغي كافة المطالبات الخاصة بالمسؤولية أو الضمان.

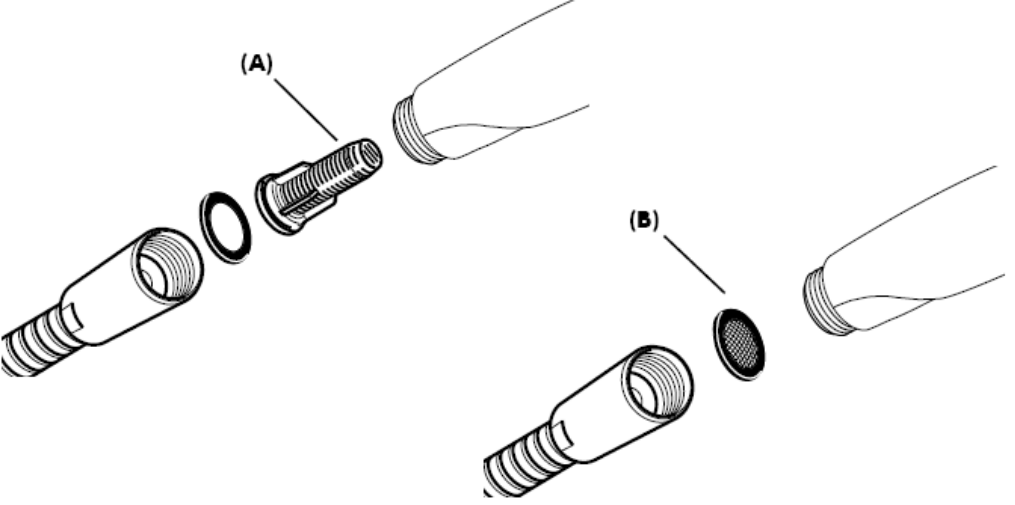

بوليصة المرشح (A)

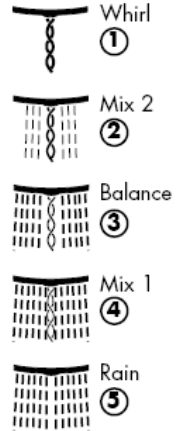
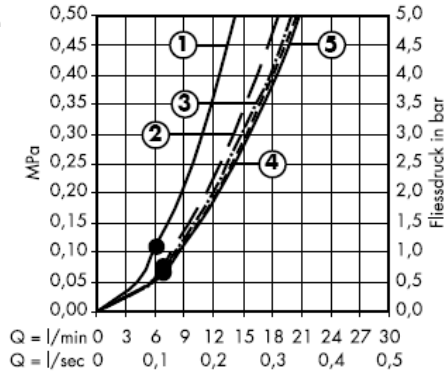

مع أجزاء المرشح (B)

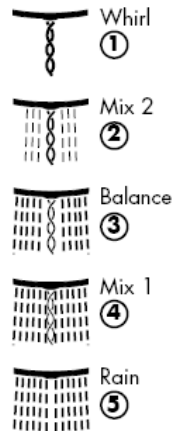
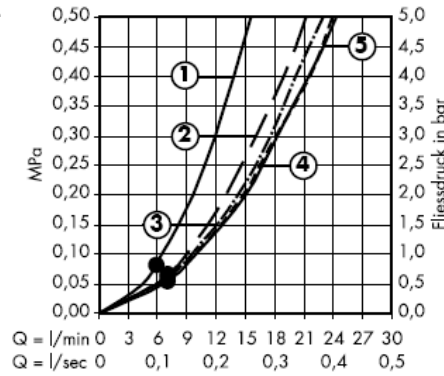

من • الوظيفة مضمونة.

بوليجة المرشح (A)

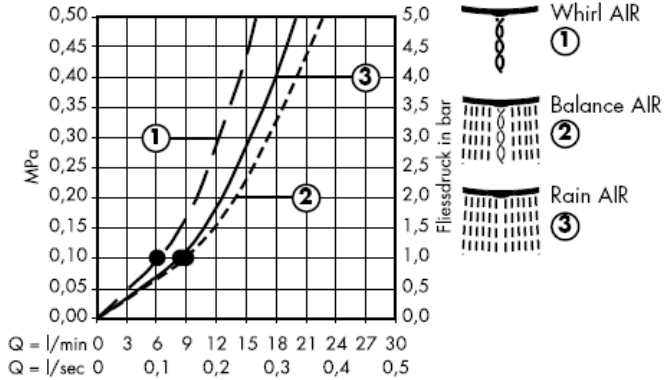

مع أجزاء المرشح (B)

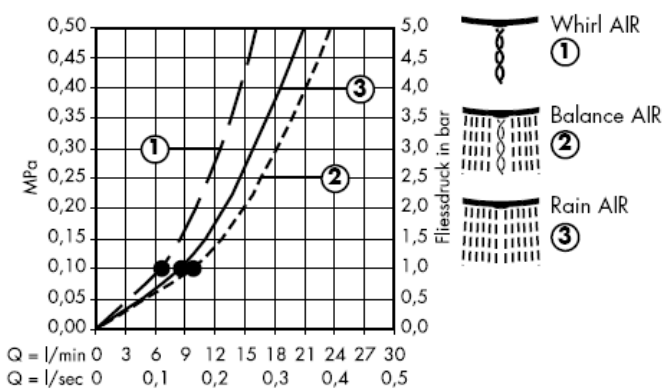

من • الوظيفة مضمونة.

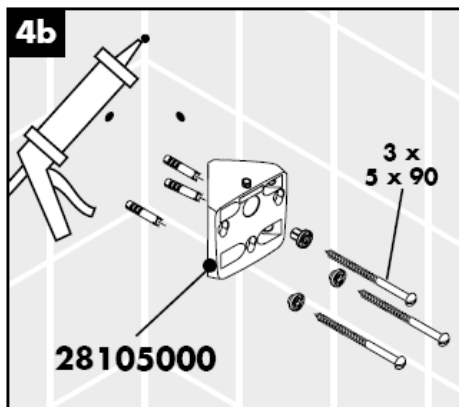
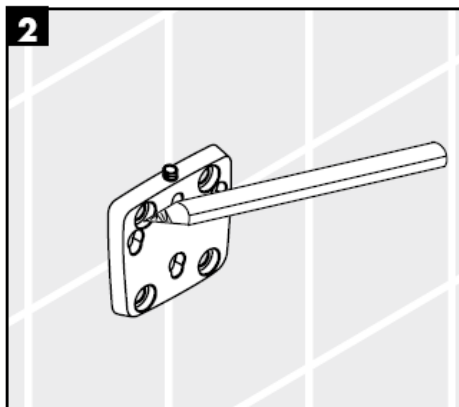
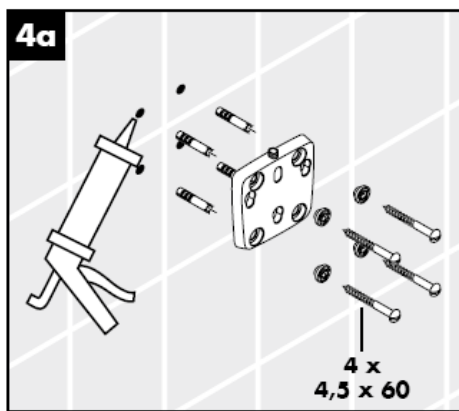
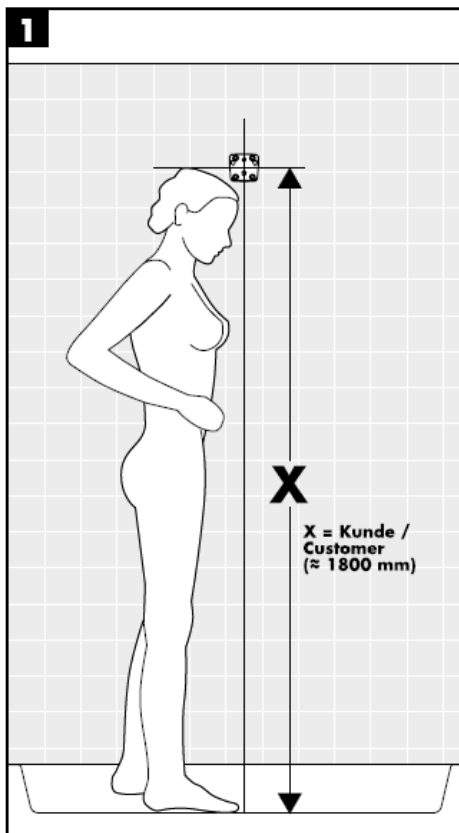



باستخدام الحلقة اللامركزية يمكن معادلة خلوص الثقب.

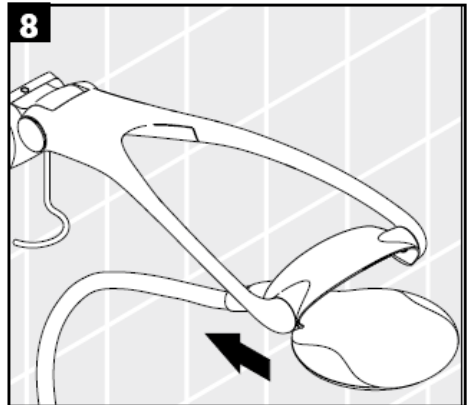
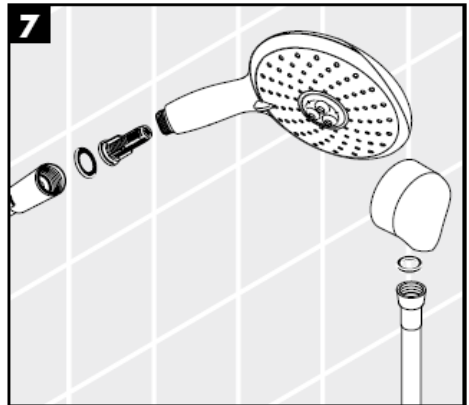
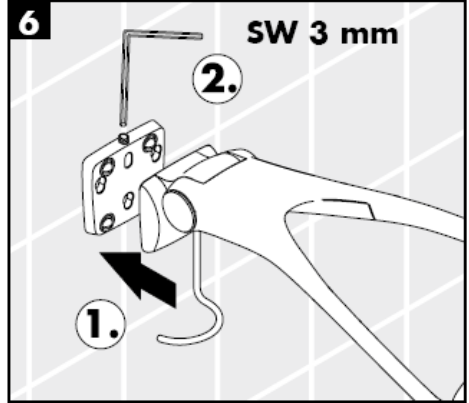

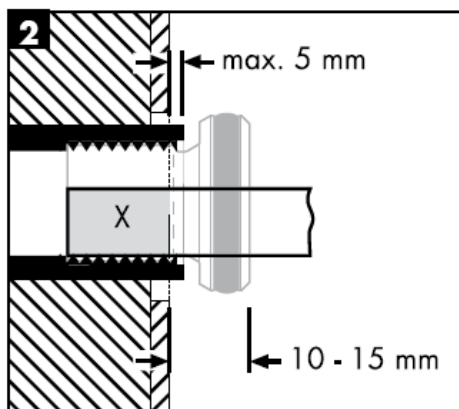
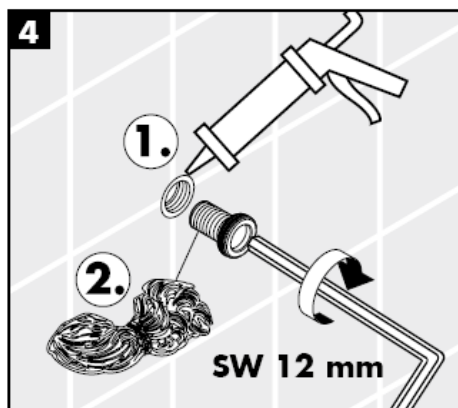
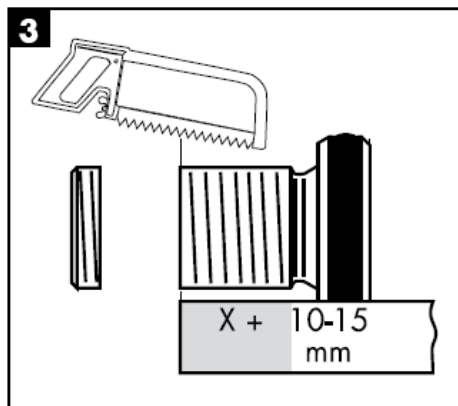
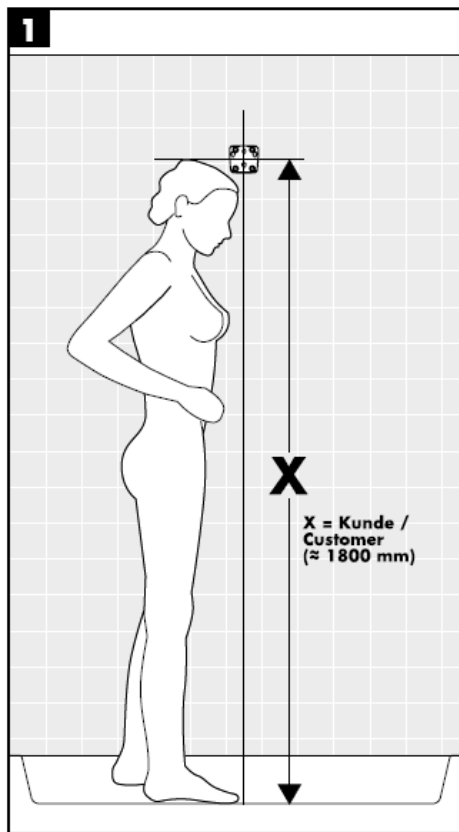

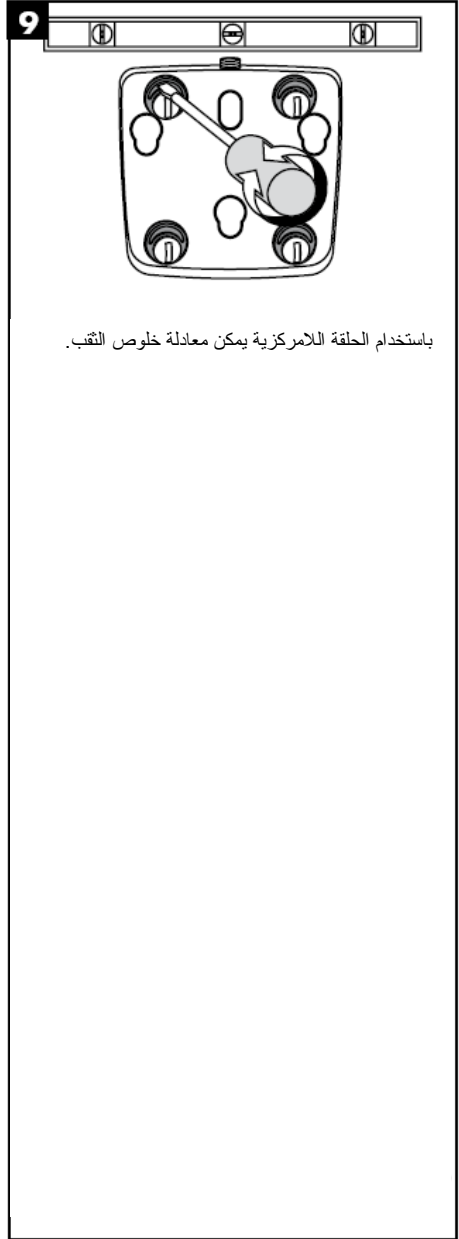
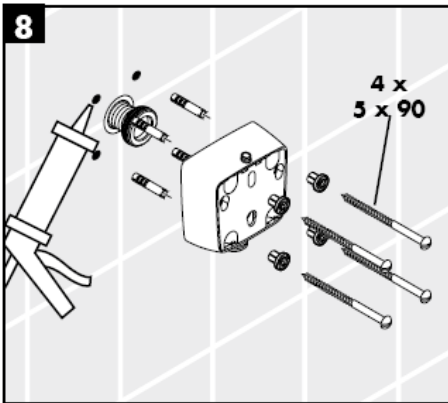
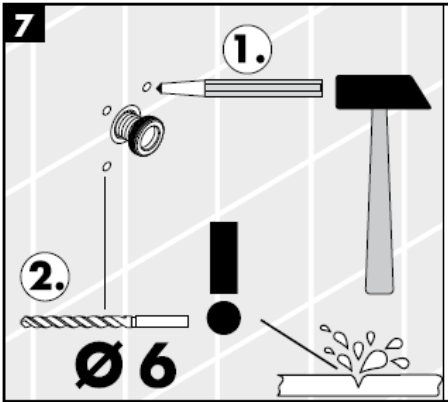
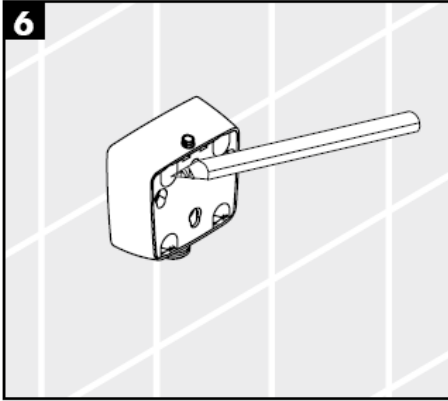



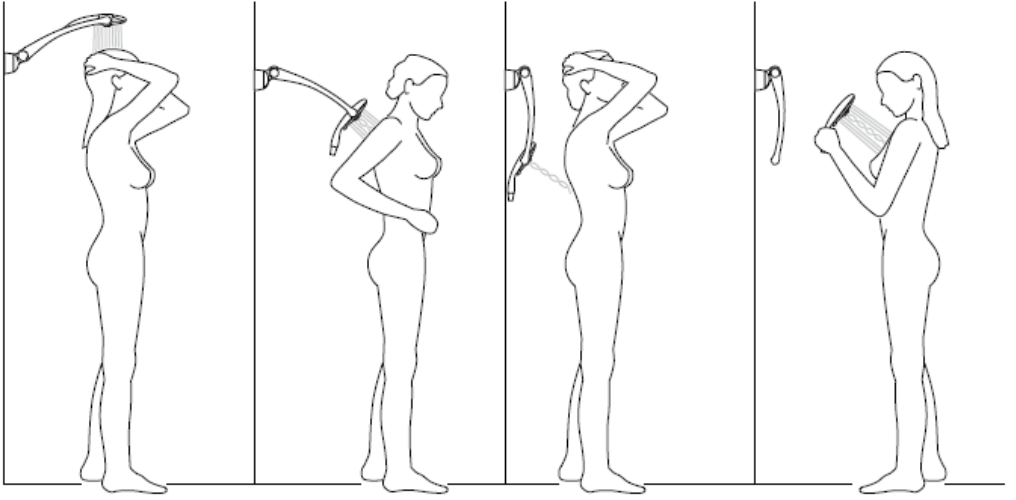

طقم Allrounder عبارة عن نظام للدش متعدد الوظائف. ويمكن استخدامه كدش علوي ثابت أو دش عادي أو دش يدوي منفصل تبعاً لوضع الذراع.

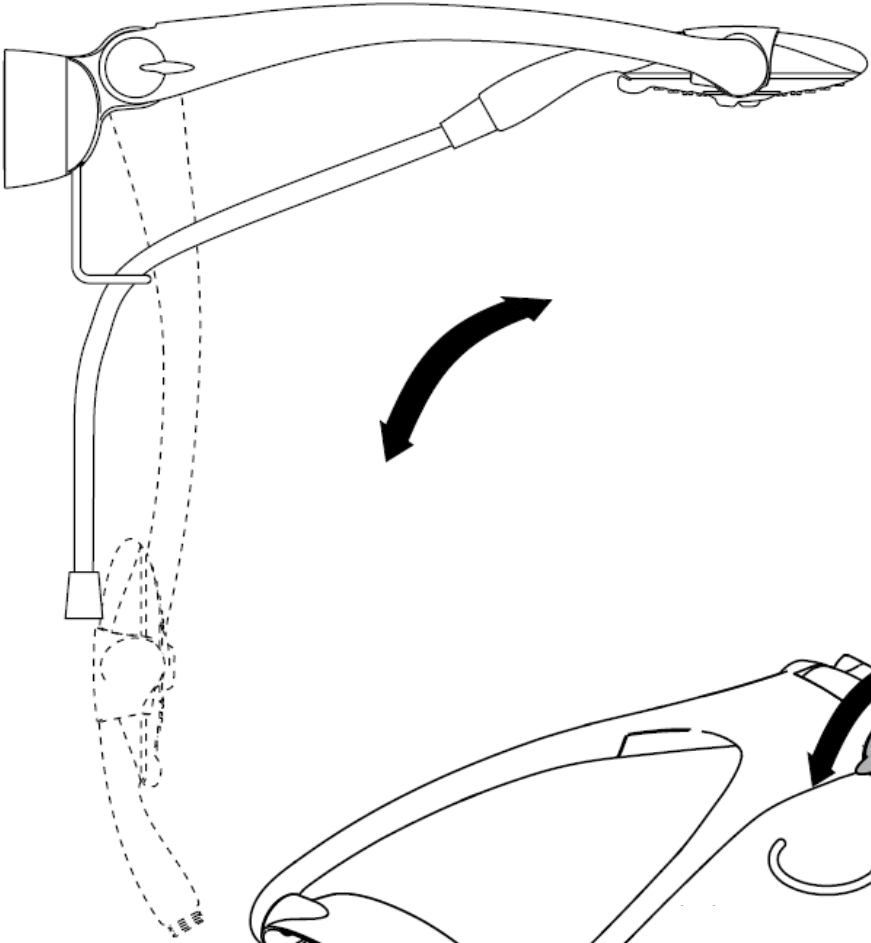

لا تحتاج وظيفة تنظيف سوى قدر بسيط من الفرك باليد لإزالة القشور الجيرية من قنوات الرشاش.

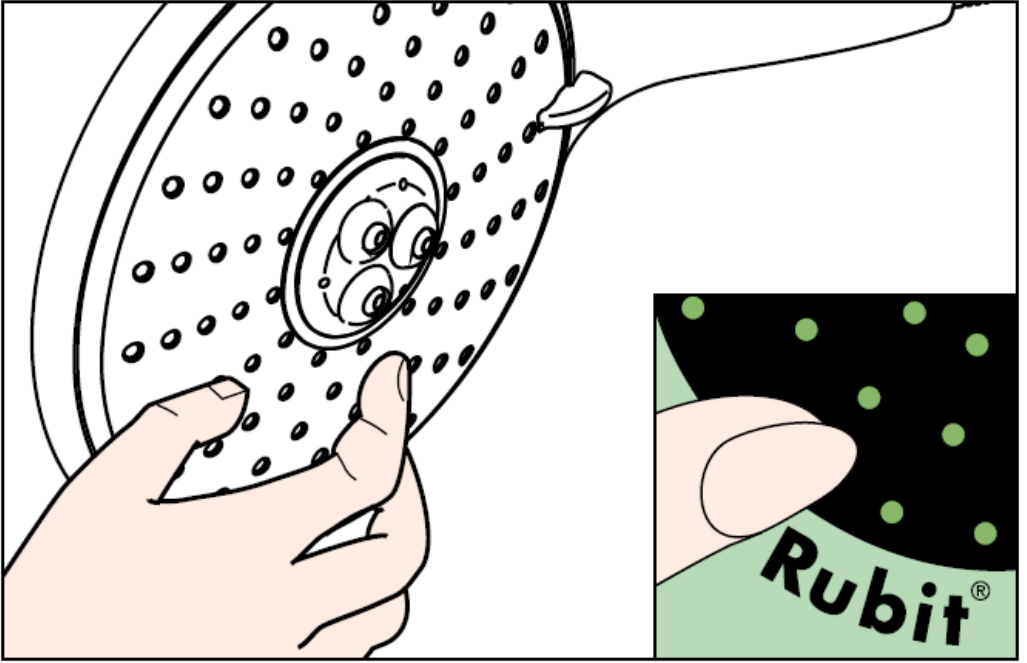

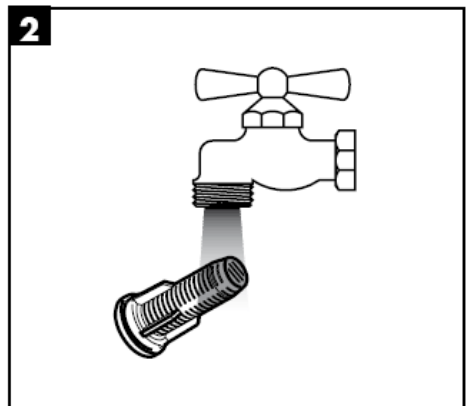
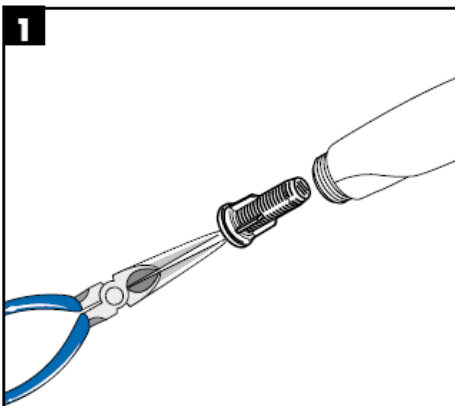
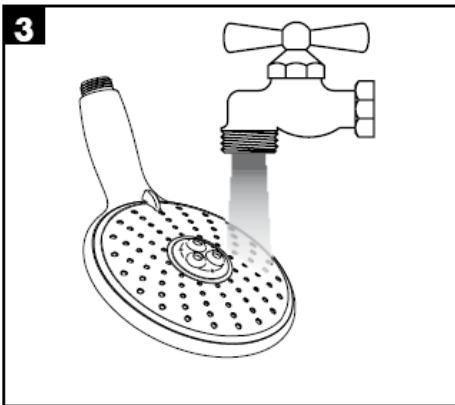
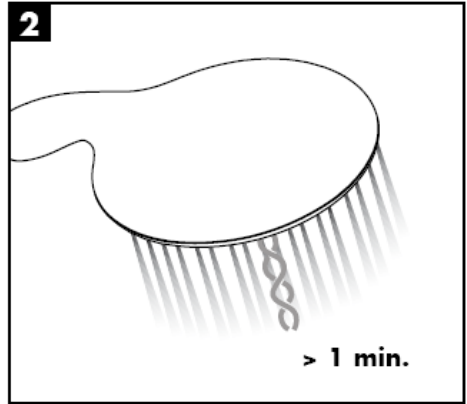
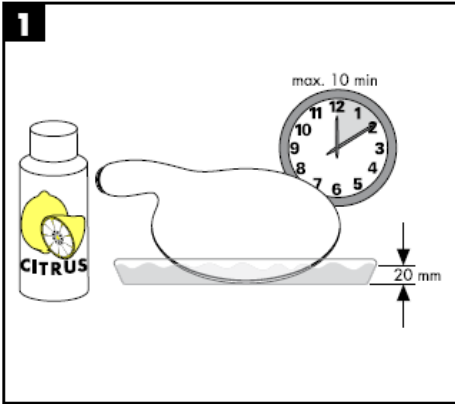

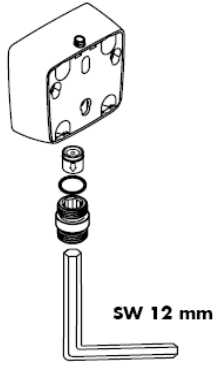

تنبيه!
يجب فحص صمامات عدم الرجوع مرة واحدة سنوياً.

hansgrohe

Hansgrohe · Postfach 1145 · D-77761 Schiltach · Telefon +49 (0) 78 36/51-1282 · Telefax +49 (0) 7836/511440
E-Mail: info@hansgrohe.com · Internet: www.hansgrohe.com

02/2008
9.06081.04
عربي

Navodila za montažo

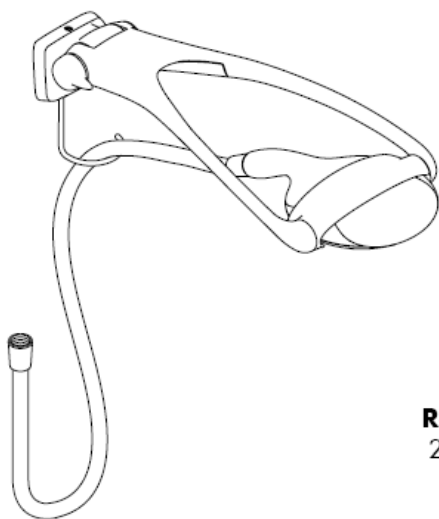

Raindance
28105000

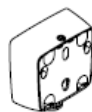

Raindance
28108000

Raindance Allrounder Set
28100000 / 28110000

hansgrohe

Raindance Allrounder Set

28100000 / 28110000

Classification acoustique et débit 28110000: ACS

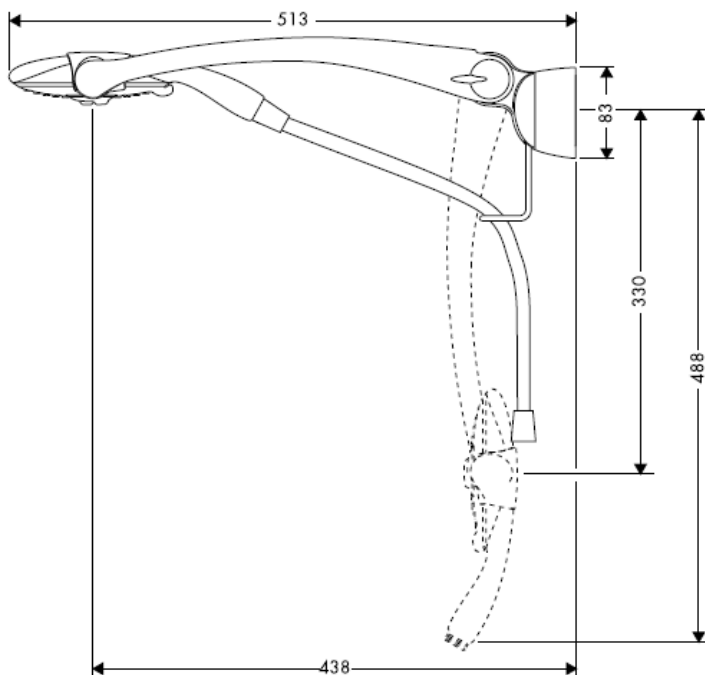

Raindance Eckmontage Set

28105000



Raindance UP-Adapter für Schlauchanschluß

28108000



Raindance Allrounder Set

28100000 / 28110000

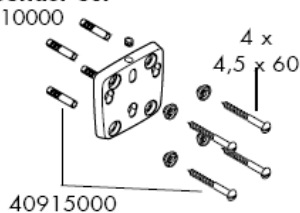

98562000

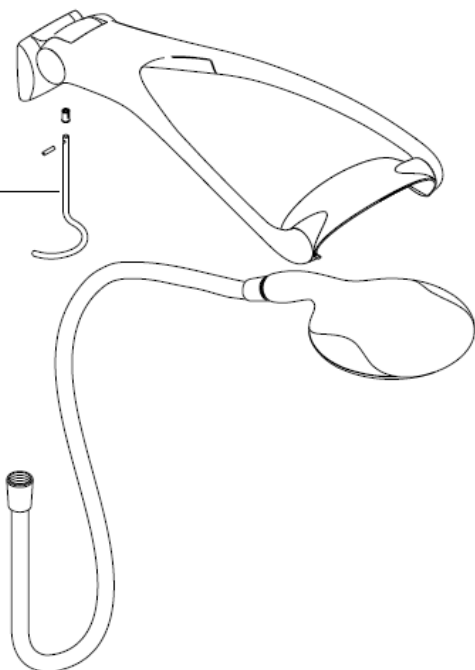

Raindance Eckmontage Set

28105000

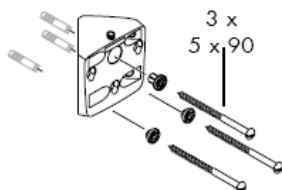

Raindance UP-Adapter für Schlauchanschluss

28108000

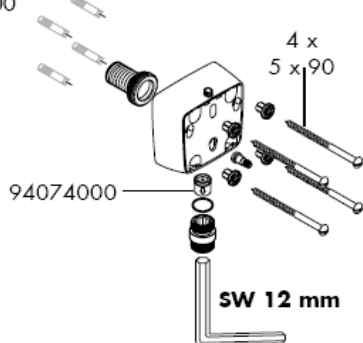

Montaža

Priloženi filtrirni vložek (A) je potrebno vgraditi, da zagotovimo standardni pretok in zaščitimo ročno prho pred umazanijo iz vodovodne napeljave. Če želite večji pretok vode, je namesto filtrirnega vložka (A) potrebno vstaviti filtrirno mrežico (B). Umazanija lahko okvari ali poškoduje dele ročne prhe. Za tako nastalo škodo Hansgrohe ne odgovarja.

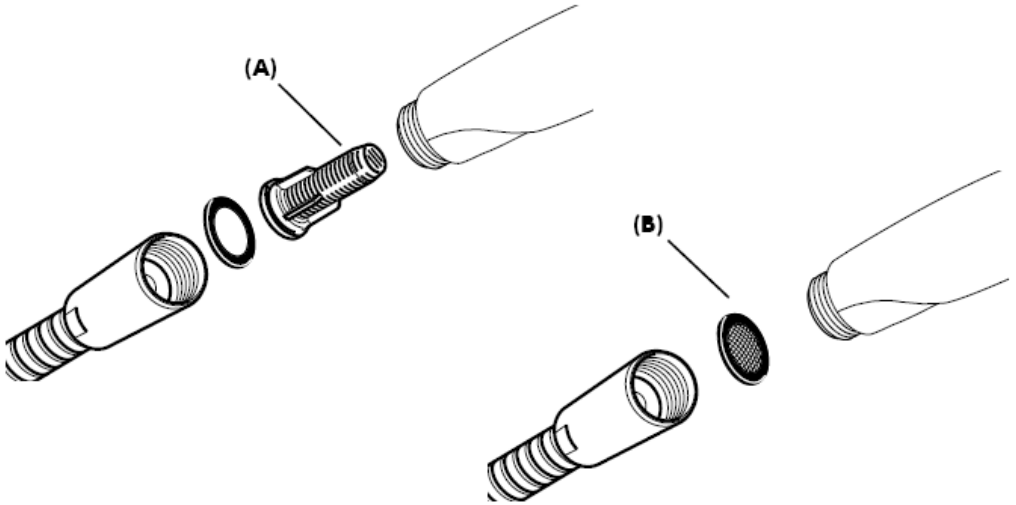

281000000

S filtrirnim vložkom (A)

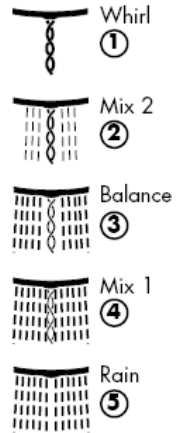
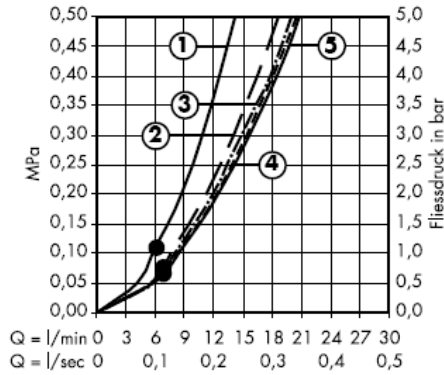

Avec joint- filtre (B)

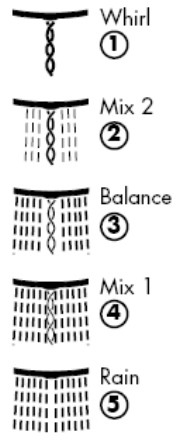
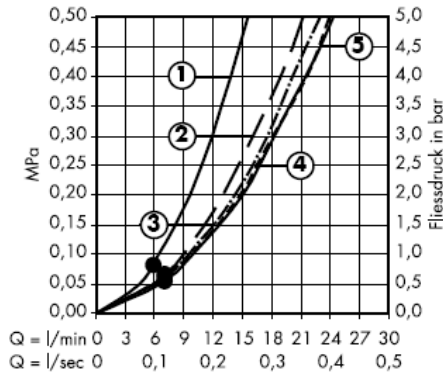

Od • je delovanje zagotovljeno.

S filtrinim vložkom (A)

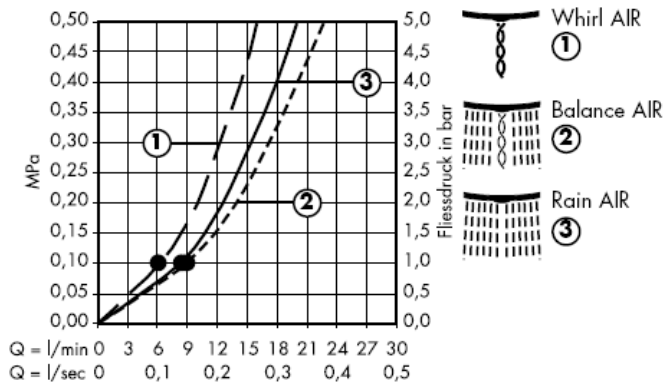

S filtrino mrežico (B)

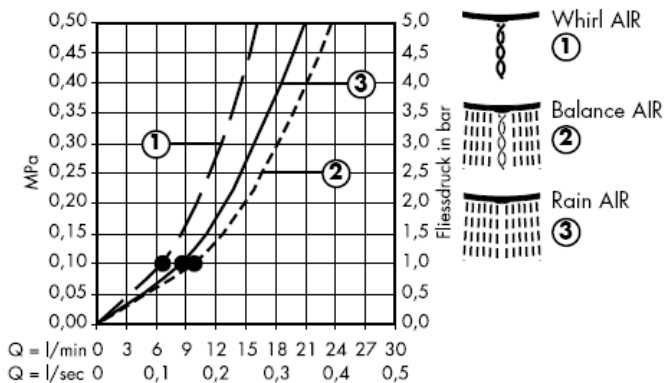

Od • je delovanje zagotovljeno.

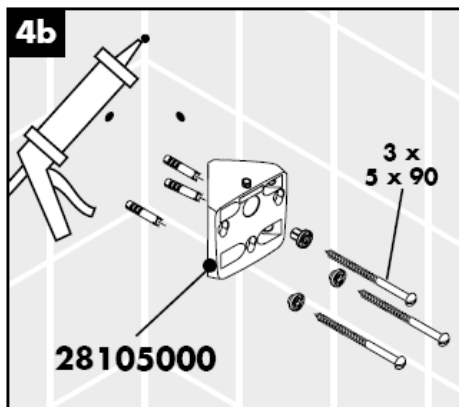
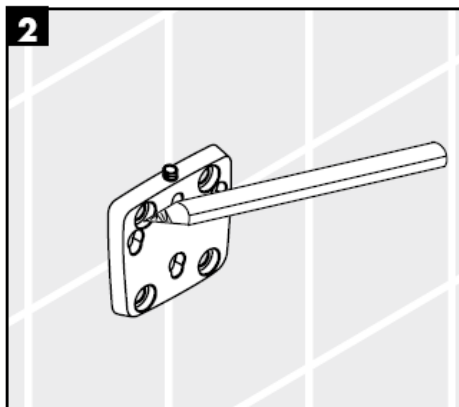
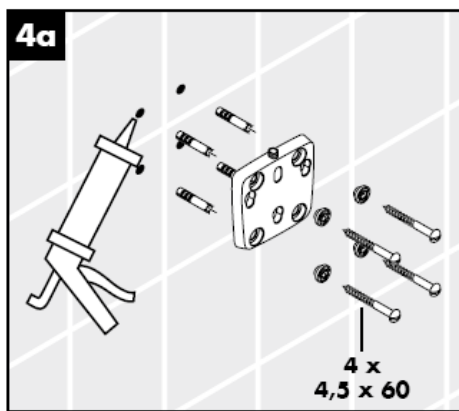
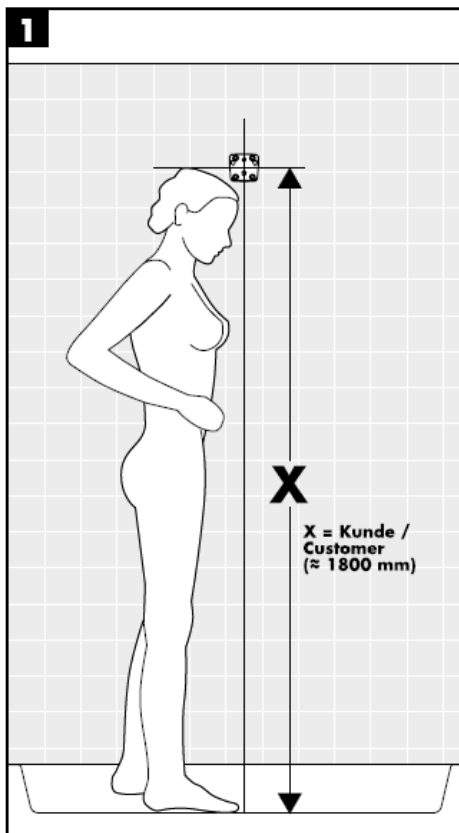

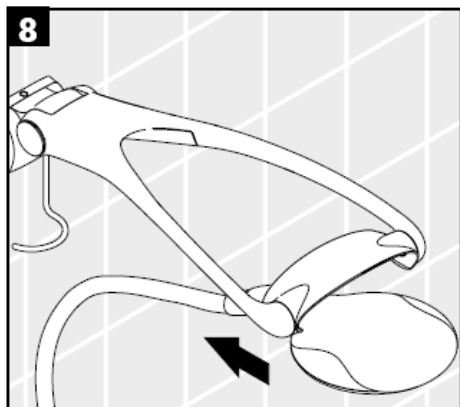
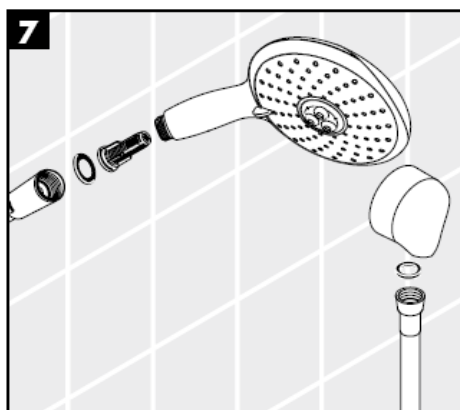
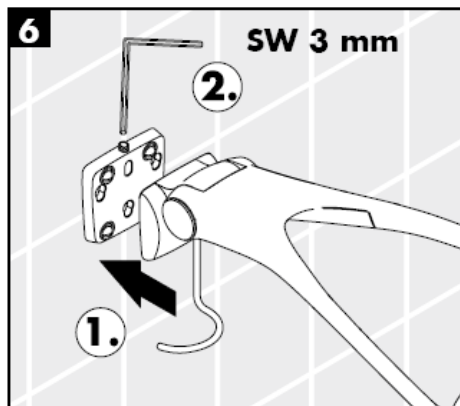

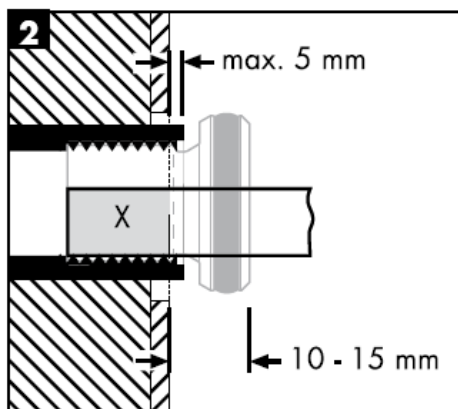
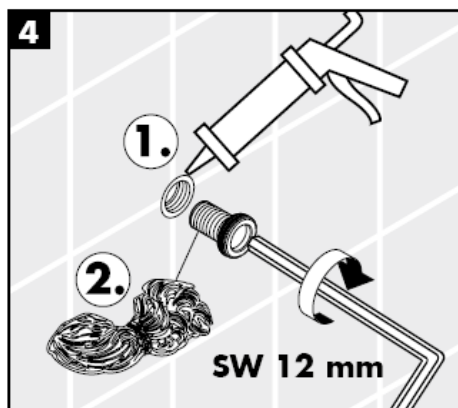
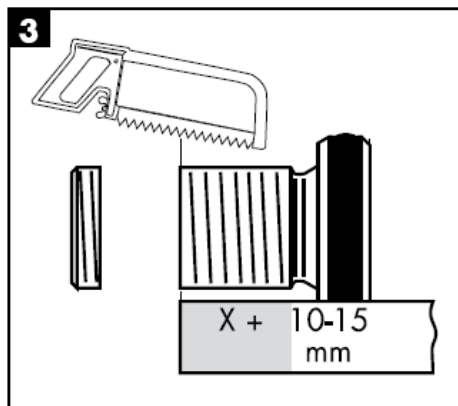
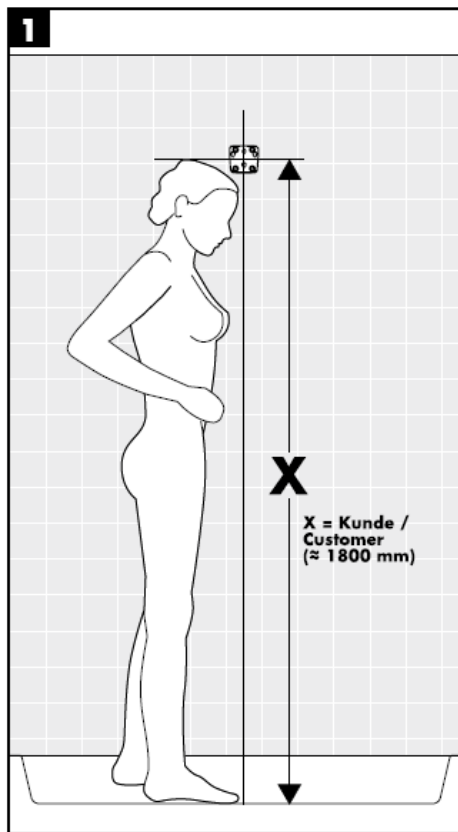

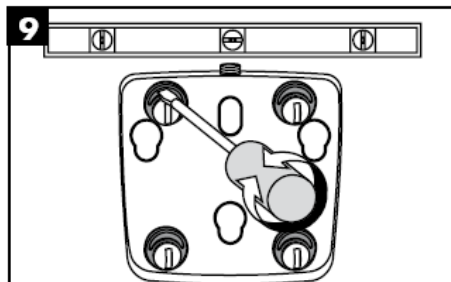
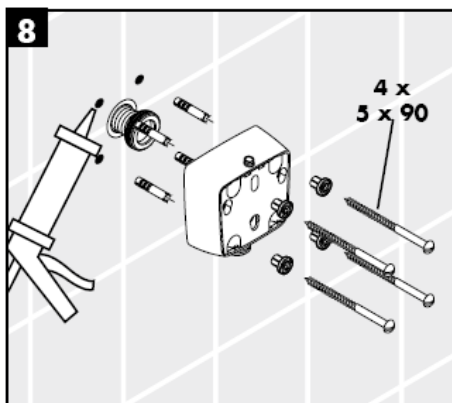
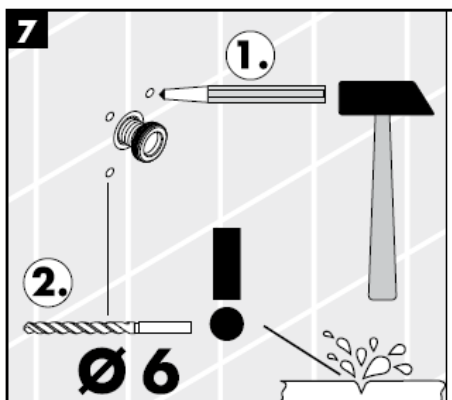
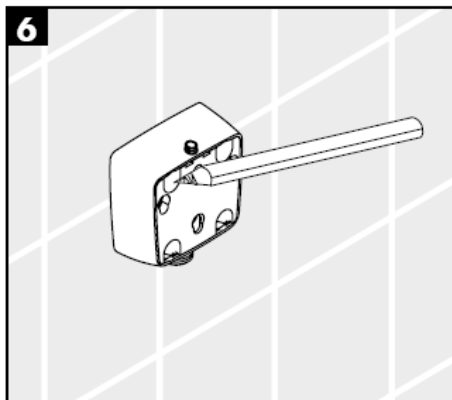

Z ekscentričnim vodilom lahko izravunate tolerance vrtanja.





"Allrounder Set" je multifunkcijski komplet za prhanje. Glede na položaj ročaja lahko uporabljate zidno prho, stranske šobe ali ločeno ročno prho.

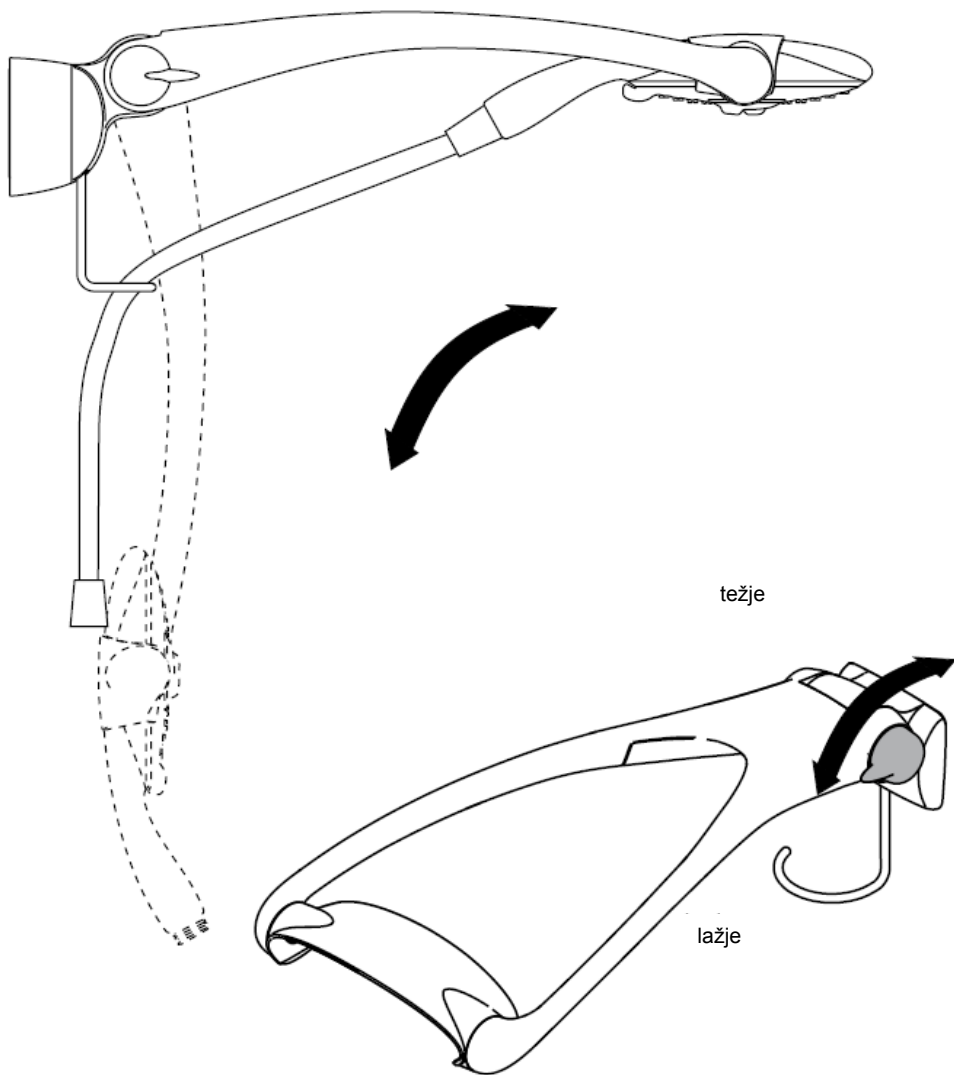

Z Rubit®, ročno čistilno funkcijo, lahko s šob očistimo vodni kamen tako, da šobe enostavno podrgnemo.

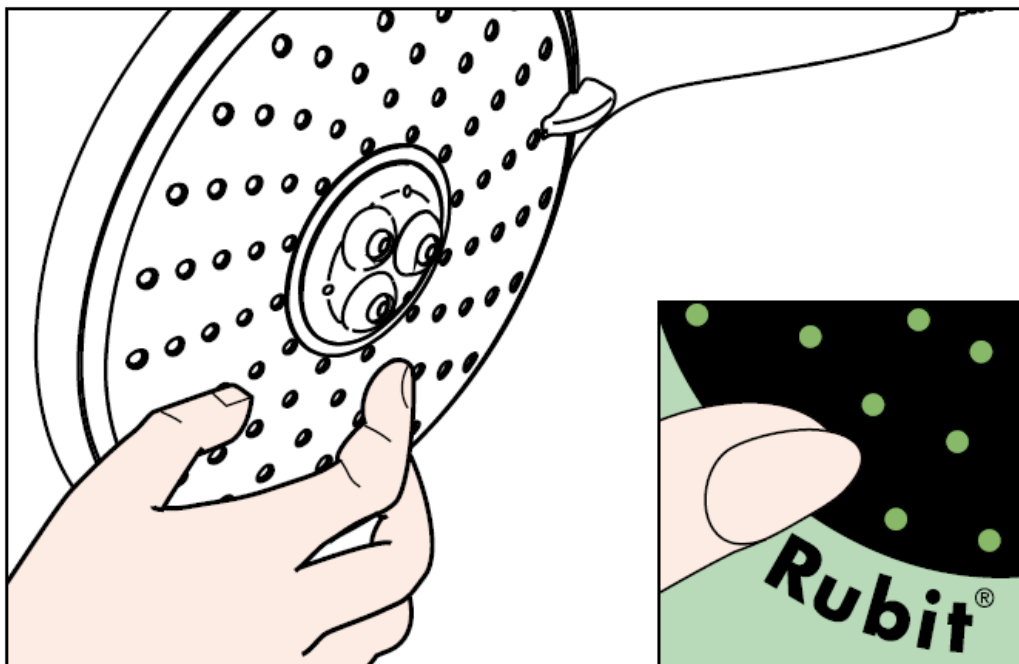

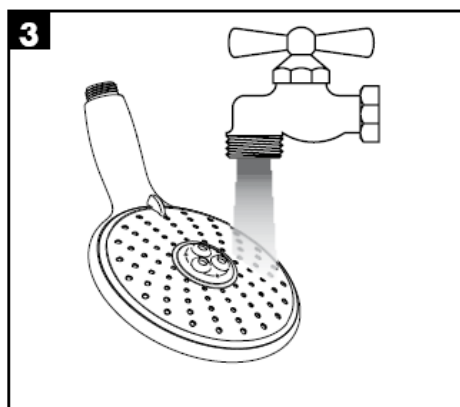
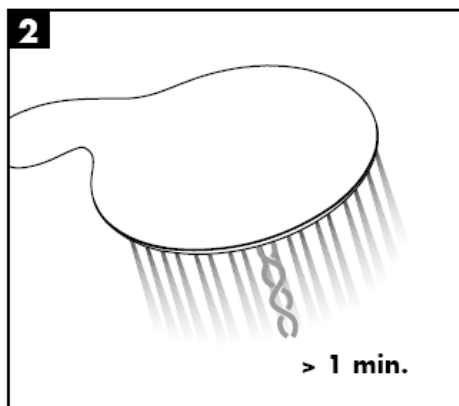
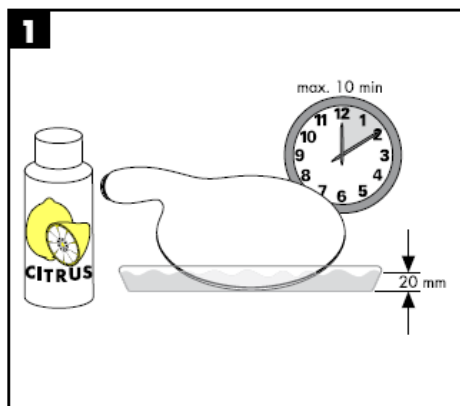

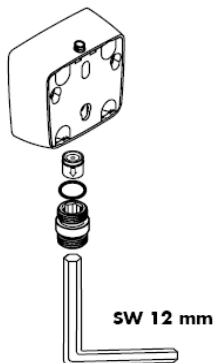

Pozor!

Delovanje protipovratnega ventila je potrebno v skladu z DIN 1988 enkrat letno testirati.

hansgrohe

Hansgrohe · Postfach 1145 · D-77761 Schiltach · Telefon +49 (0) 78 36/51-1282 · Telefax +49 (0) 7836/511440
E-Mail: info@hansgrohe.com · Internet: www.hansgrohe.com

02/2008
9.06081.04
Slovenski

Paigaldusjuhend

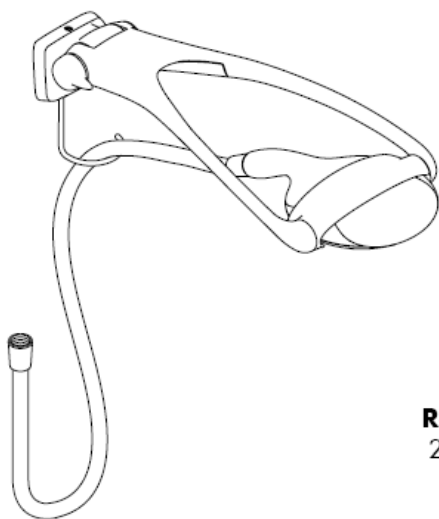

Raindance
28105000

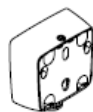

Raindance
28108000

Raindance Allrounder Set
28100000 / 28110000

hansgrohe

Raindance Allrounder Set

28100000 / 28110000

Classification acoustique et débit 28110000: ACS

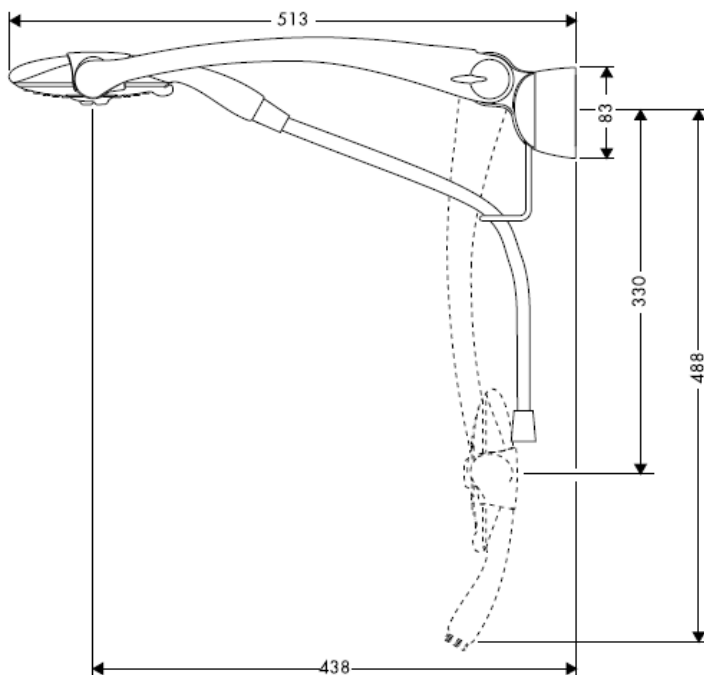

Raindance Eckmontage Set

28105000



Raindance UP-Adapter für Schlauchanschluß

28108000



Raindance Allrounder Set

28100000 / 28110000

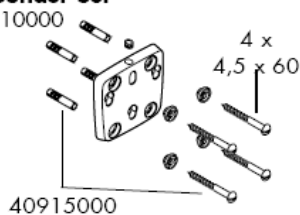

98562000

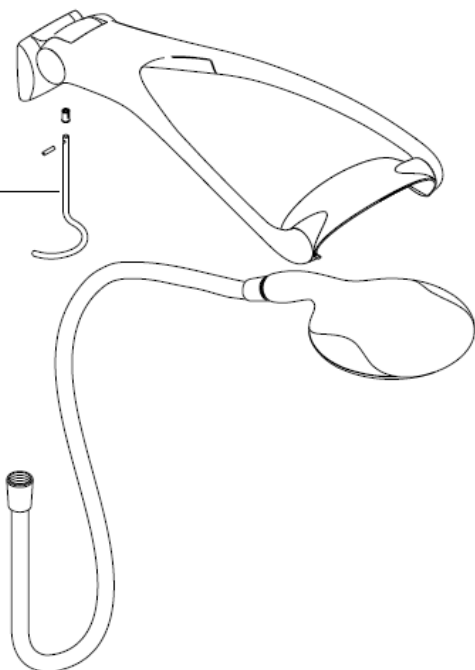

Raindance Eckmontage Set

28105000

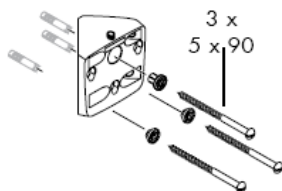

Raindance UP-Adapter für Schlauchanschluss

28108000

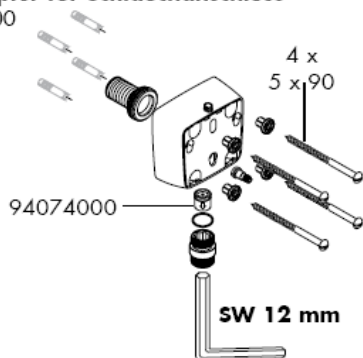

Paigaldamine

Käsiduši standardse läbivoolu puhul peab veevärgist tuleva mustuse vastu paigaldama kaasasoleva filtri A. Kui soovite suuremat läbivoolu, peab selle asemel kasutama filtrit B. Filtri A või B mittepaigaldamisel käsiduši võib sissetulev mustus funktsioneerimist kahjustada ja/või rikkuda käsiduši detaile. Sellest tulenevate kahjude eest Hansgrohe ei vastuta.

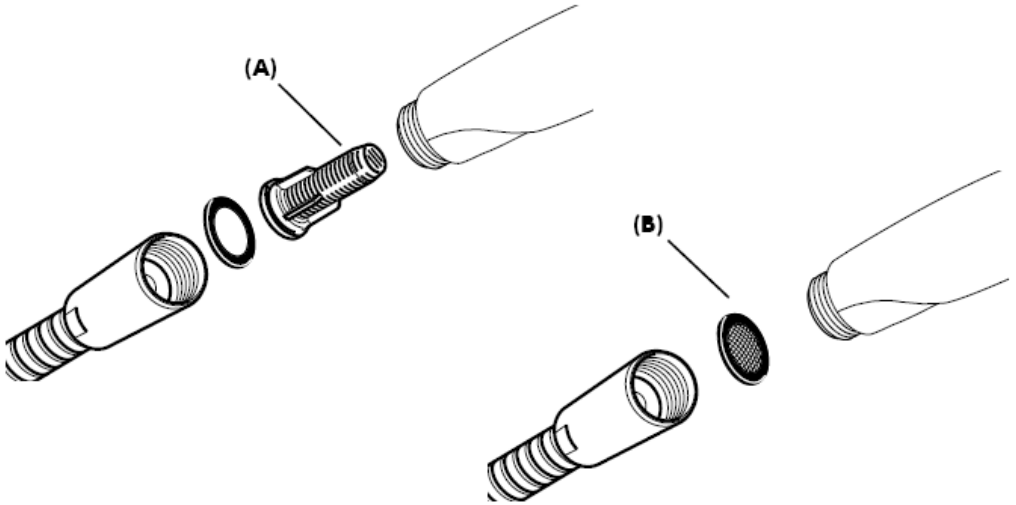

Filtriga (A)

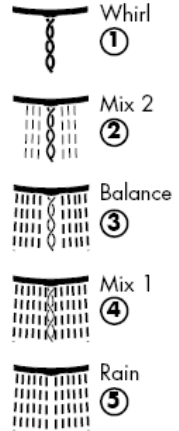
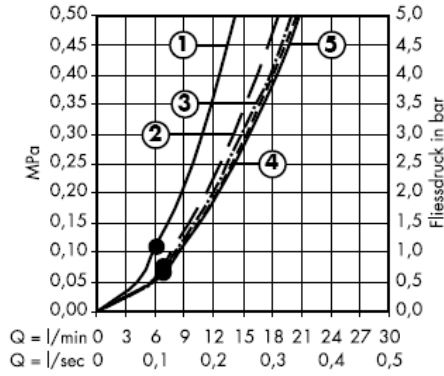

Sõeltihendiga B

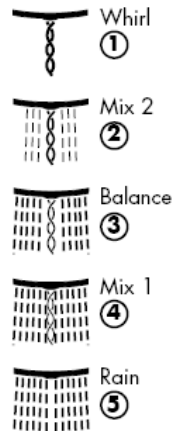
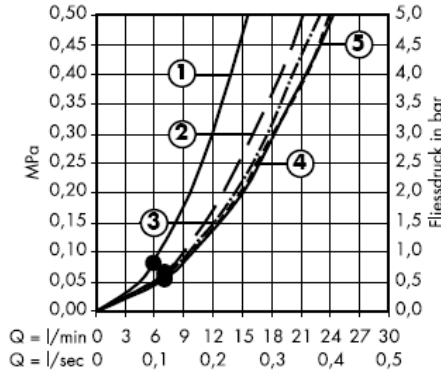

Alates • on funktsioneerimine garanteeritud

Filtriga (A)

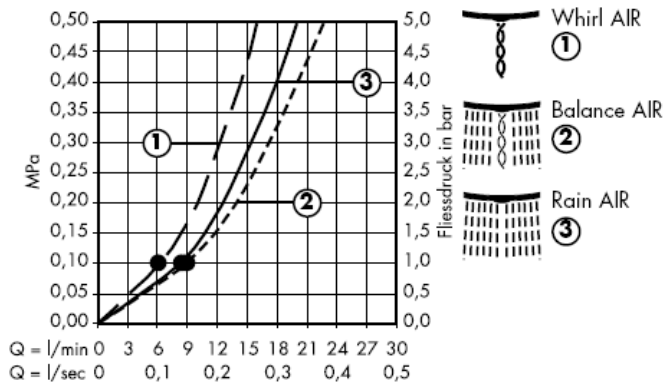

Sõeltihendiga B

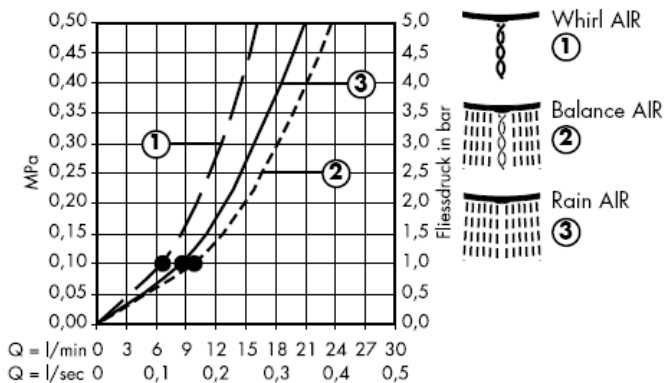

Alates • on funktsioneerimine garanteeritud

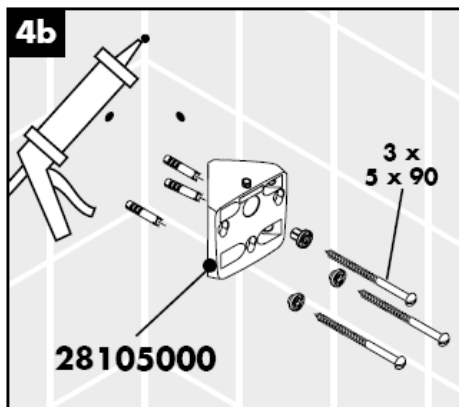
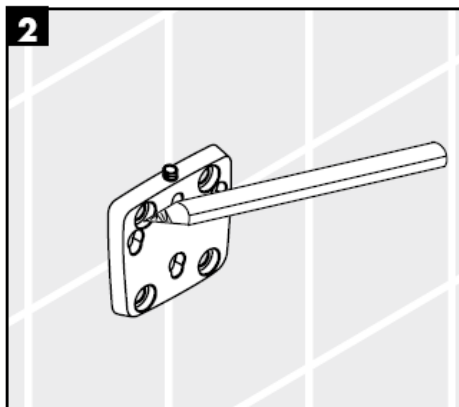

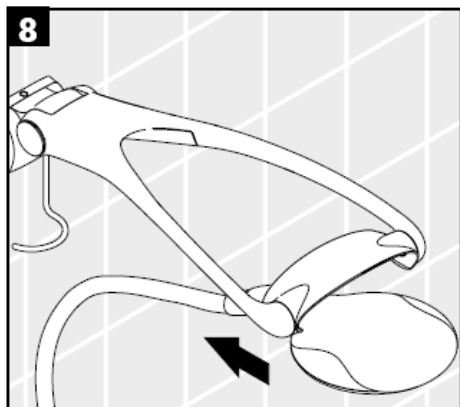
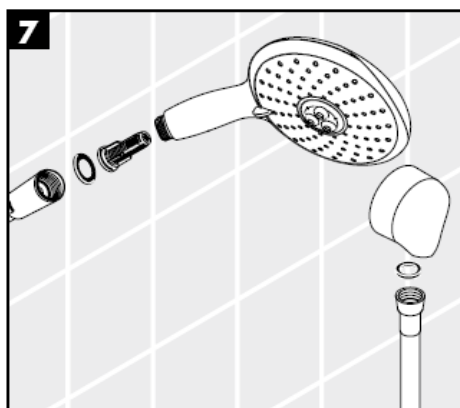
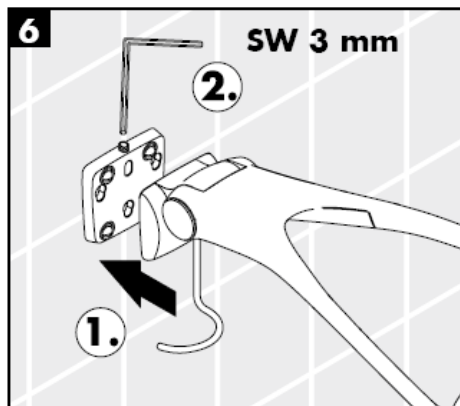
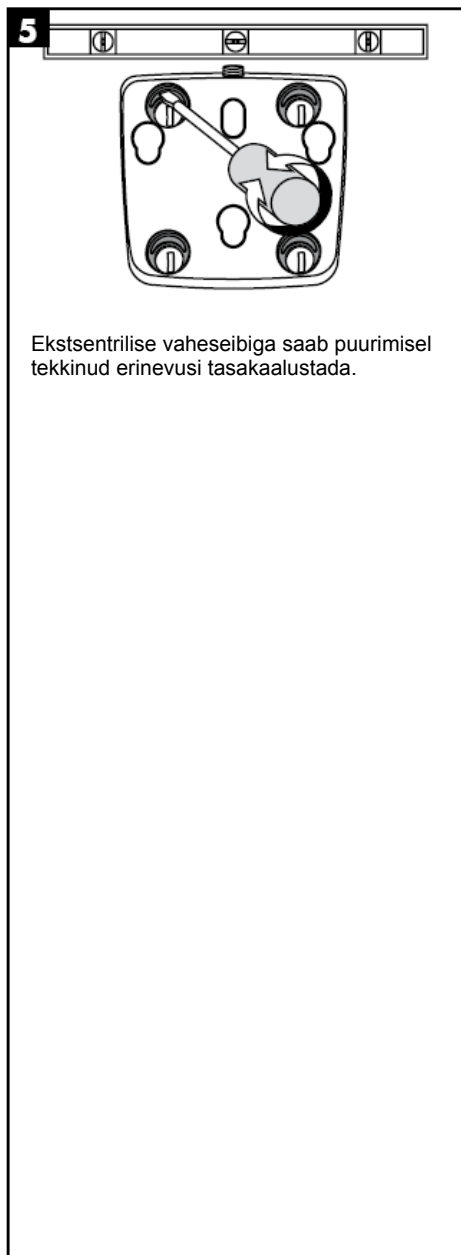

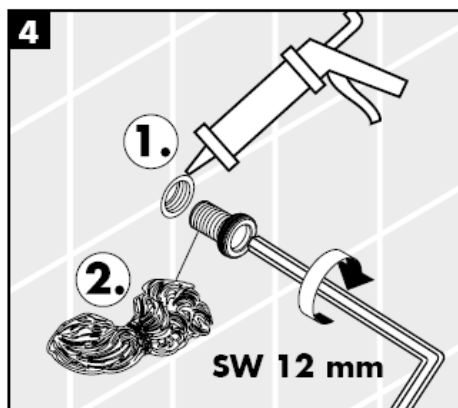
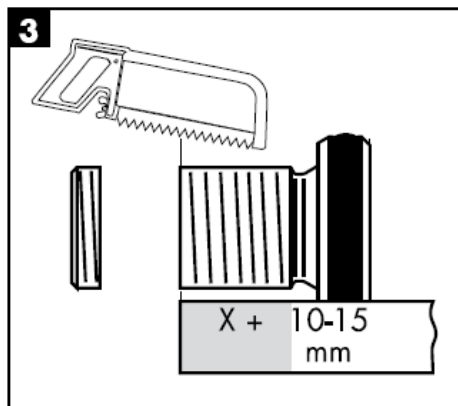
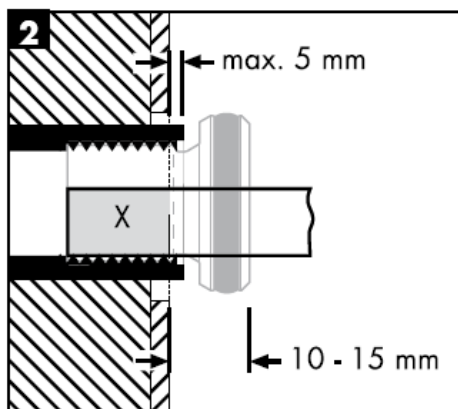
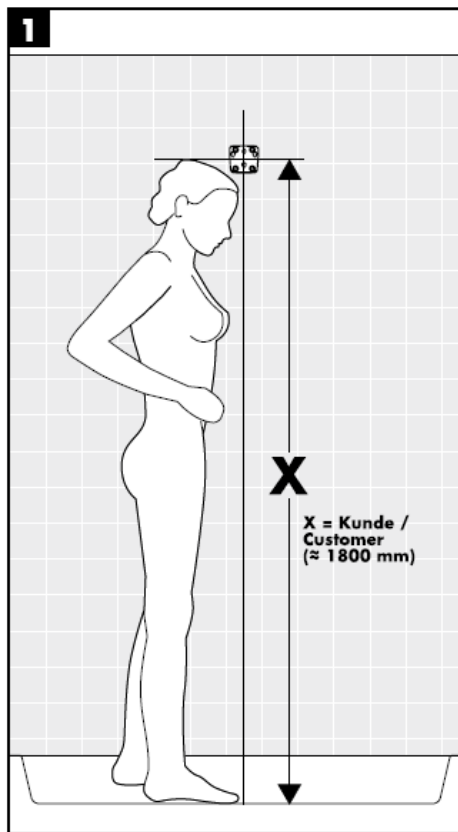

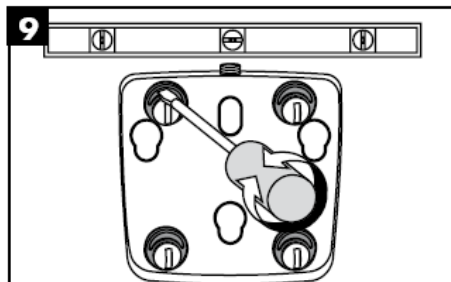
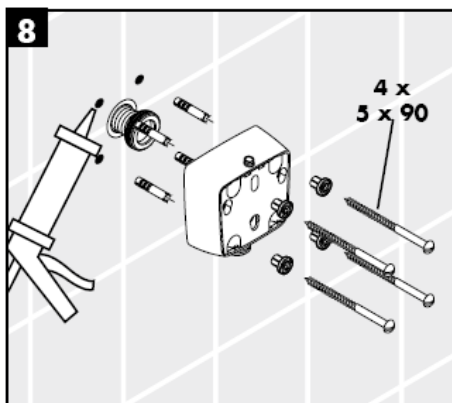
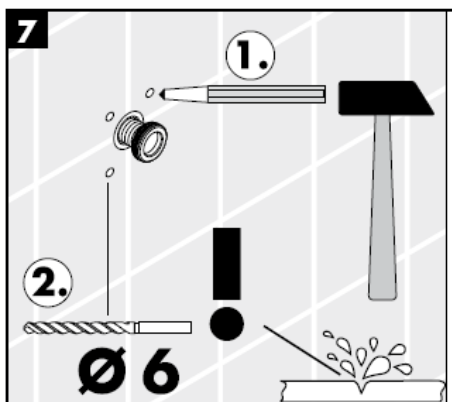
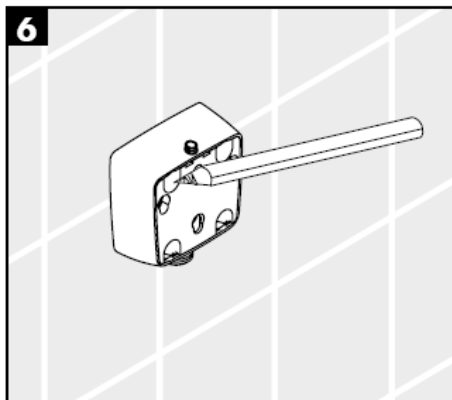

Ekstsentrilise vaheseibiga saab puurimisel tekkinud erinevusi tasakaalustada.

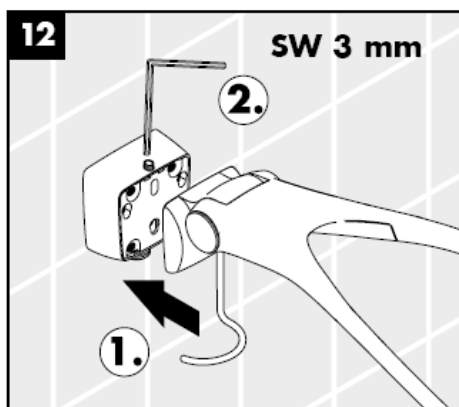
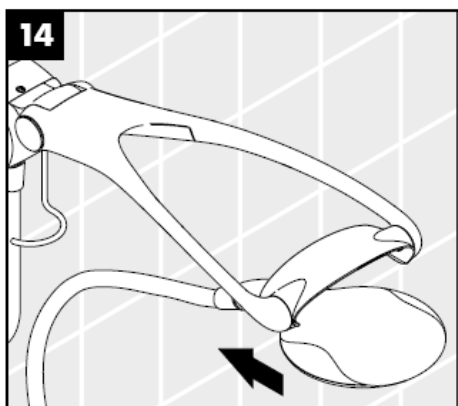
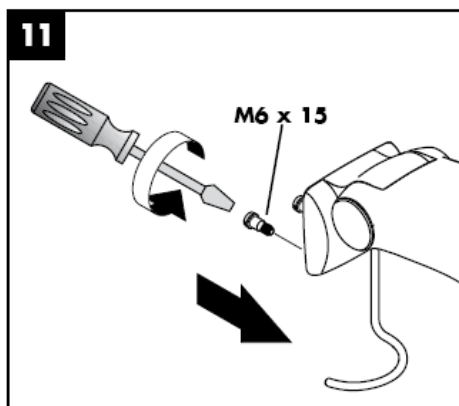
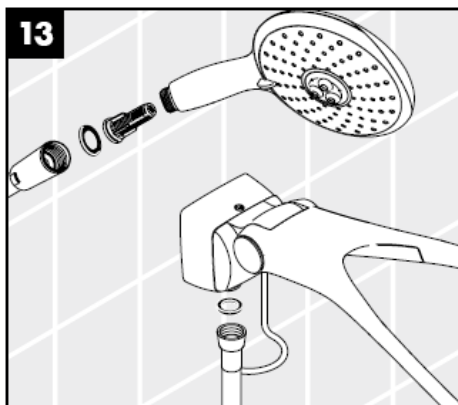
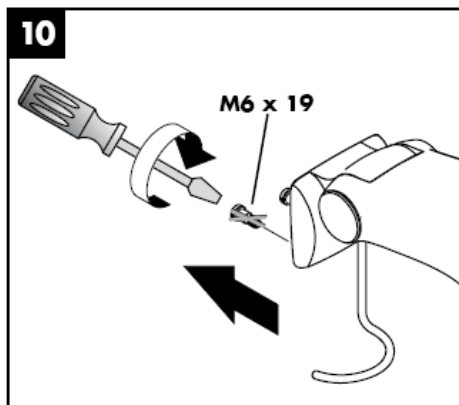



Allrounder set kujutab endast multifunktsionaalset dušisüsteemi. Vastavalt hoova asetusele saab kasutada ülepeadušši, kehadušši või eraldi käsidušši.

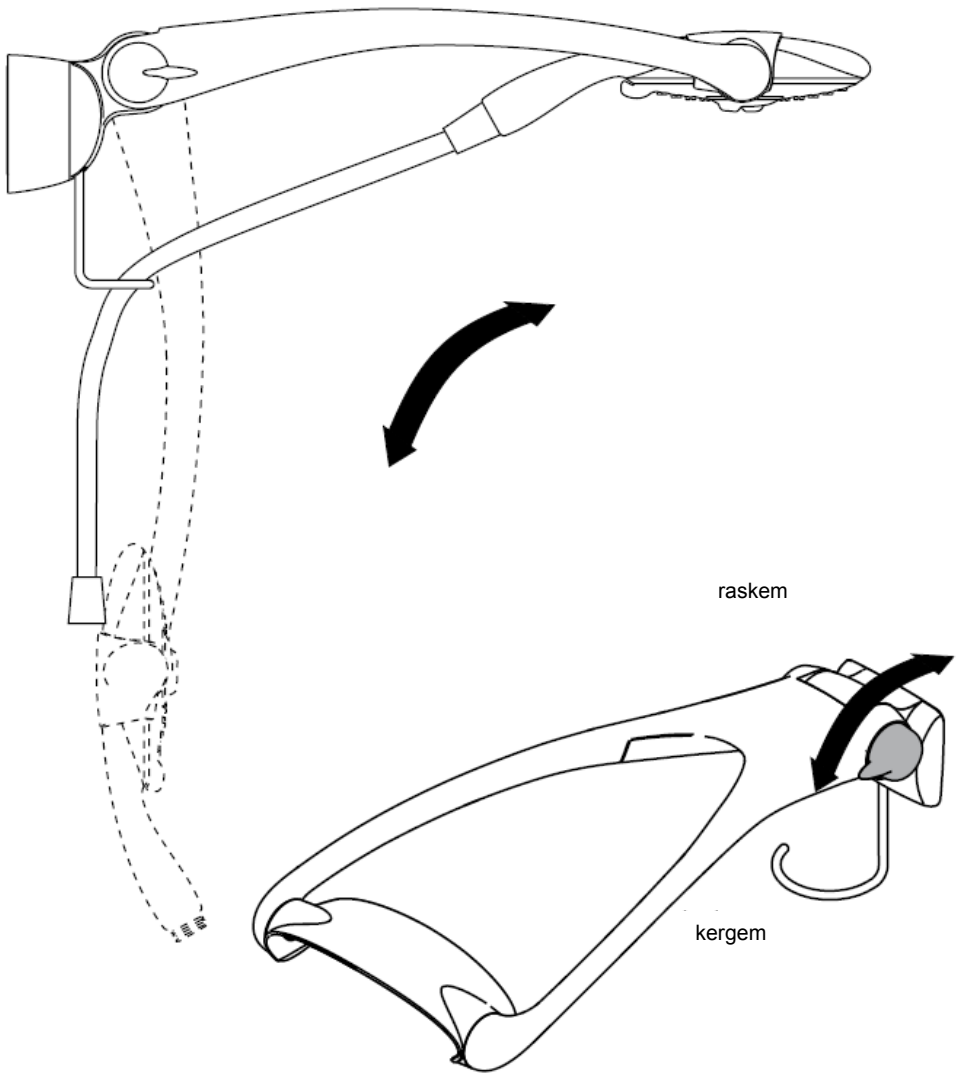

Puhastamine

Käsitsi puhastamise funktsiooni Rubit® puhul on vajalik vaid kerge ülehõõrumine, eemaldamaks dušikanalitest katlakivi.

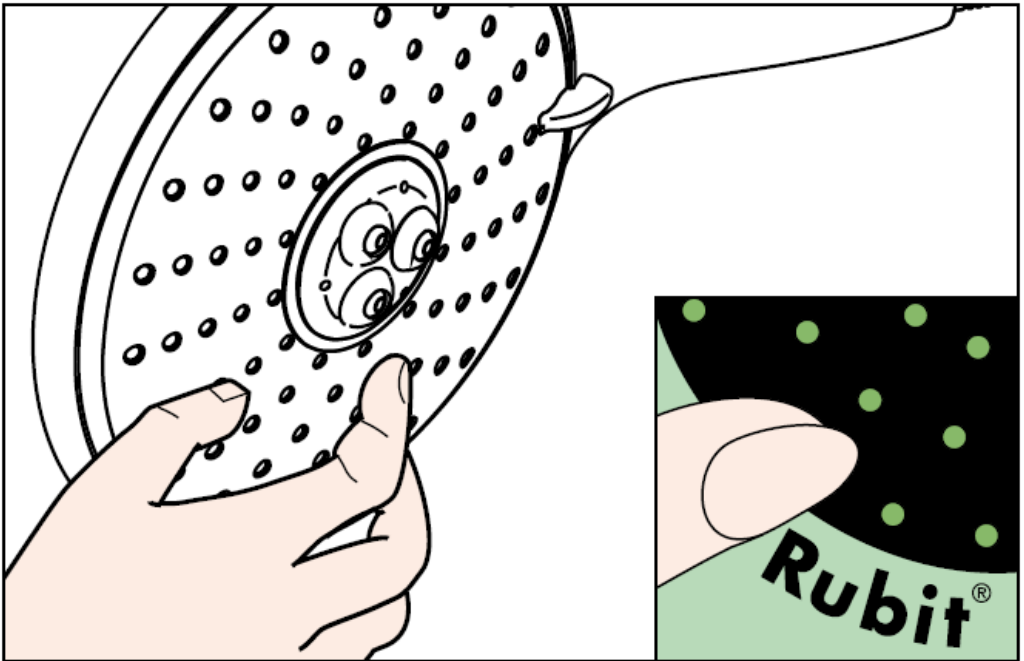

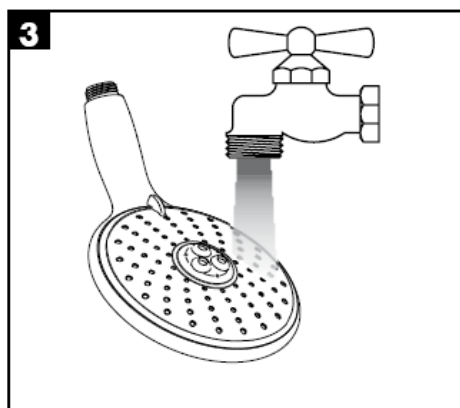
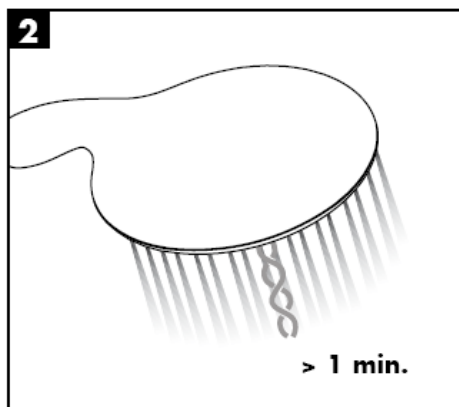
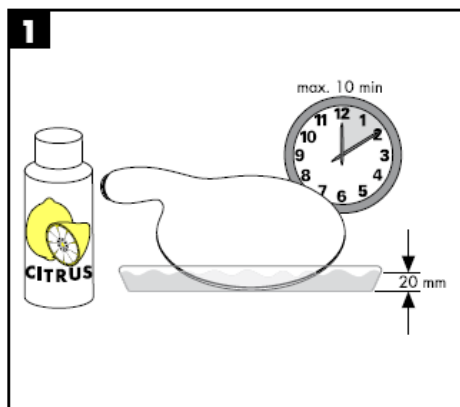

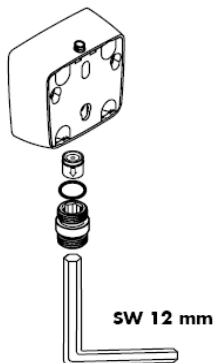

Tähelepanu!

Tagasilöögiklappide toimimist tuleb kontrollida vastavalt standardile DIN 1988 kord aastas.

hansgrohe

Hansgrohe · Postfach 1145 · D-77761 Schiltach · Telefon +49 (0) 78 36/51-1282 · Telefax +49 (0) 7836/511440
E-Mail: info@hansgrohe.com · Internet: www.hansgrohe.com

02/2008
9.06081.04
Estonia

Montāžas instrukcija

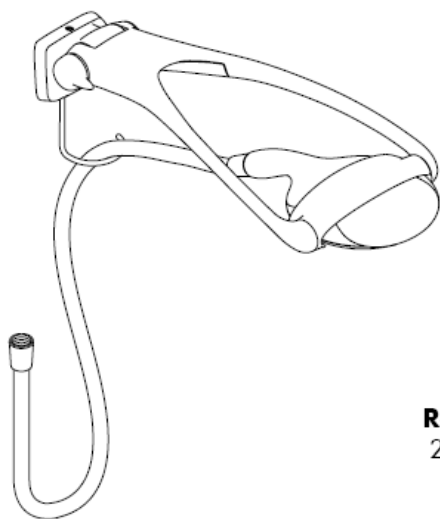

Raindance
28105000

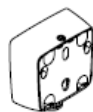

Raindance
28108000

Raindance Allrounder Set
28100000 / 28110000

hansgrohe

Raindance Allrounder Set

28100000 / 28110000

Classification acoustique et débit 28110000: ACS

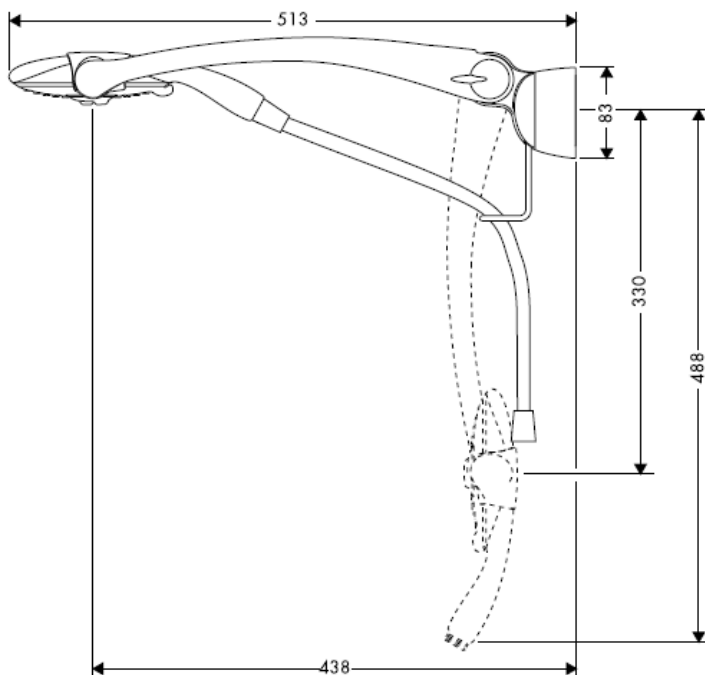

Raindance Eckmontage Set

28105000



Raindance UP-Adapter für Schlauchanschluß

28108000



Raindance Allrounder Set

28100000 / 28110000

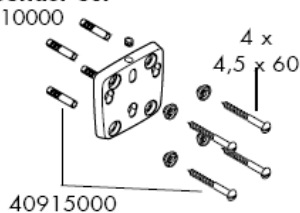

98562000

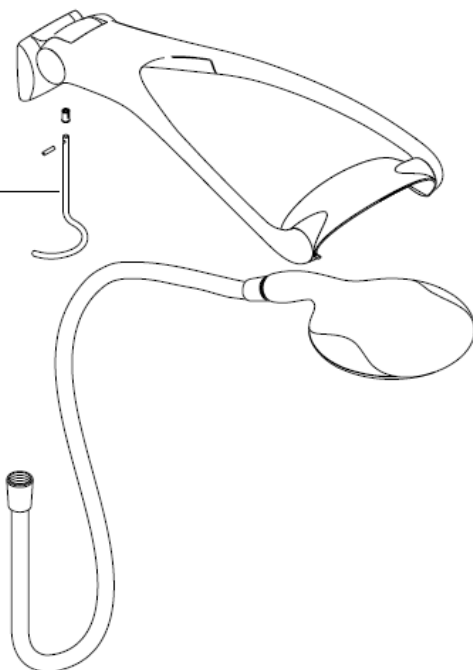

Raindance Eckmontage Set

28105000

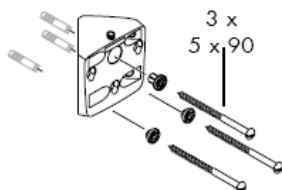

Raindance UP-Adapter für Schlauchanschluss

28108000

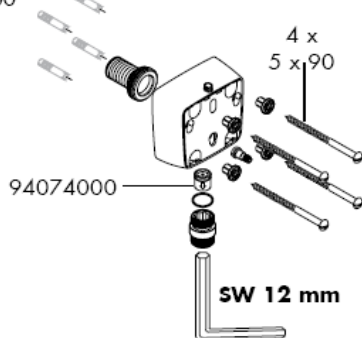

Montāža

Lai nodrošinātu rokas dušas normālu ūdens caurplūdi un izvairītos no netīrumu ieskalošanas no ūdensvada, jāiemontē komplektā esošais filtrs (A). Ja ir nepieciešamība pēc lielākas ūdens caurplūdes, tad filtra (A) vietā jāizmanto sietiņš (B). Ieskalotie netīrumi var traucēt dušas funkciju un / vai arī izraisīt rokas dušas funkciju bojājumus, par kuriem Hansgrohe nenes atbildību.

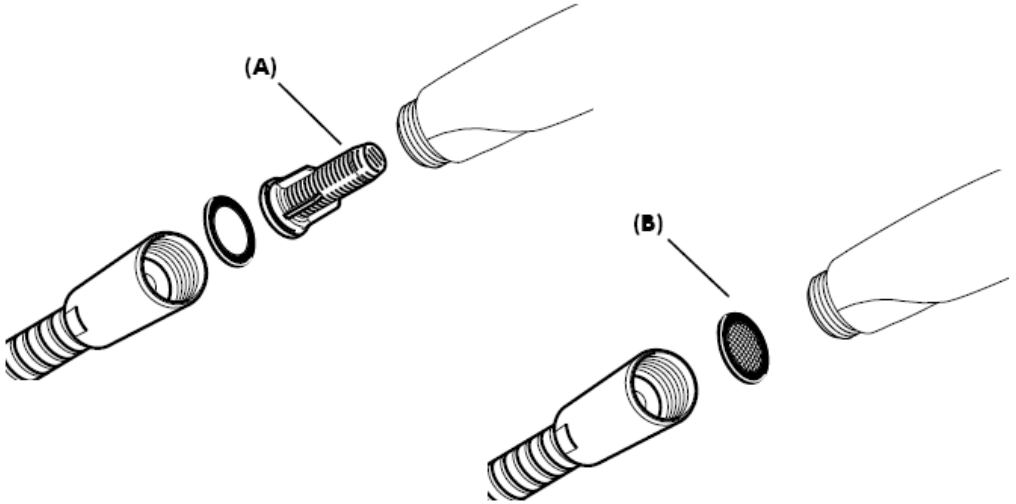

281000000

Ar filtra ieliktni (A)

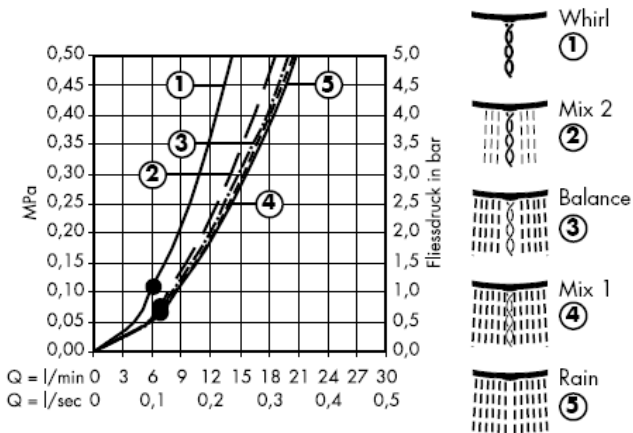

Ar filtra blīvējumu (B)

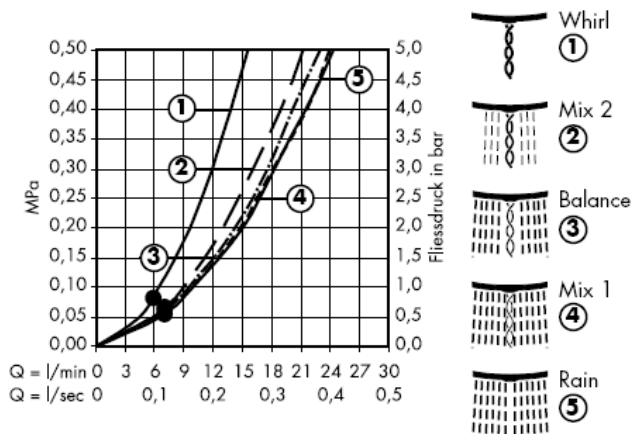

No • funkcija nodrošināta

Ar filtra ieliktni (A)

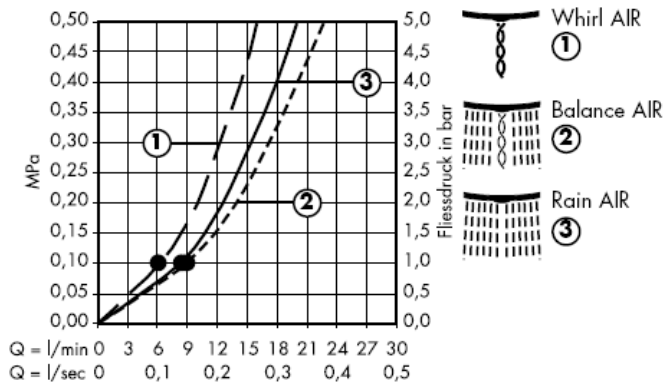

Ar filtra blīvējumu (B)

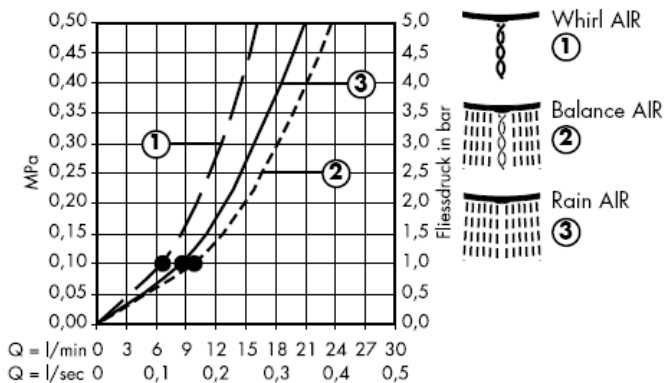

No • funkcija nodrošināta

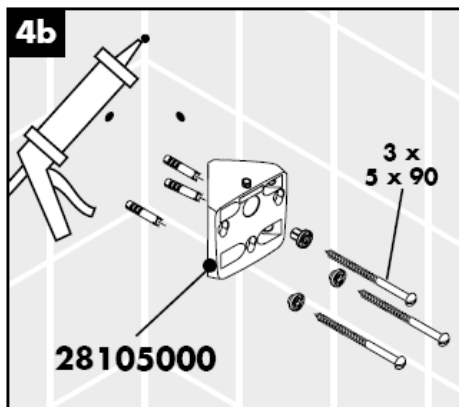
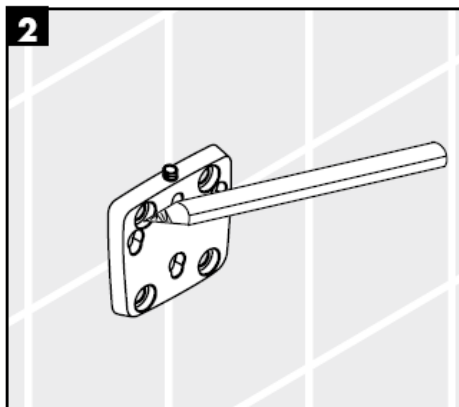

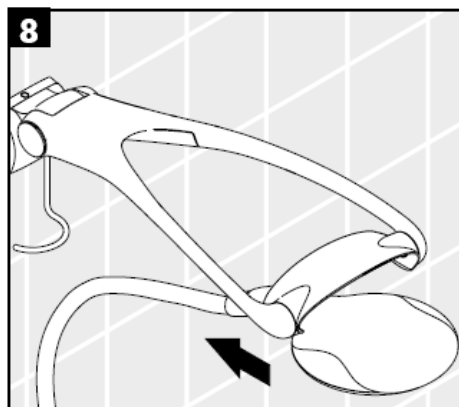
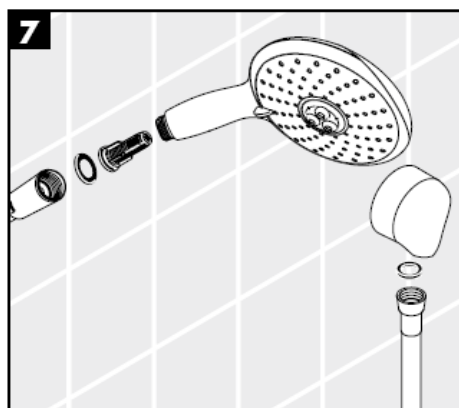
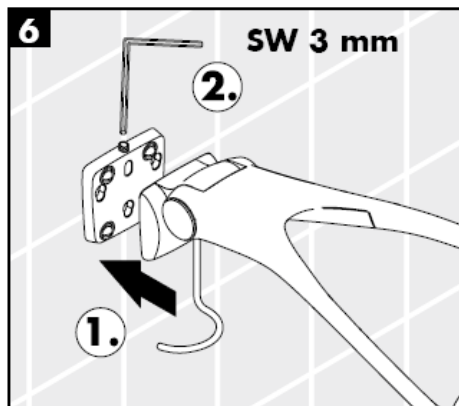

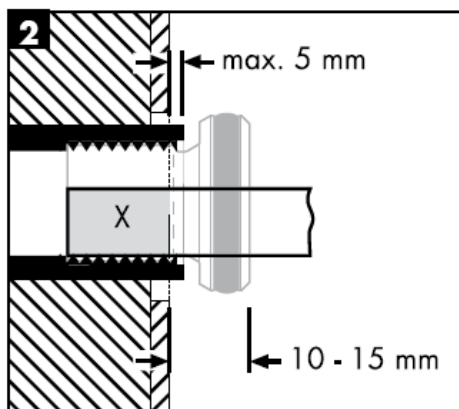
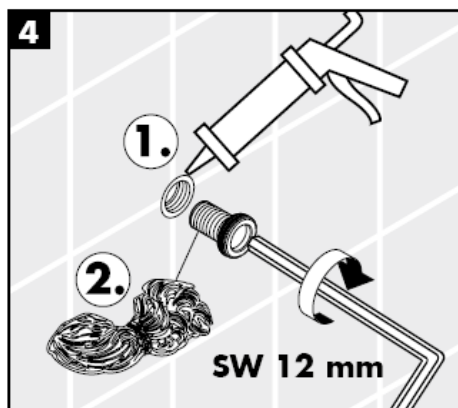
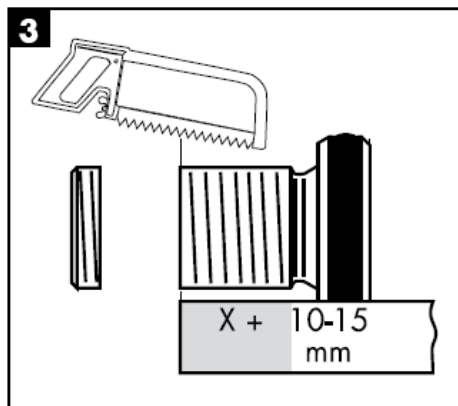
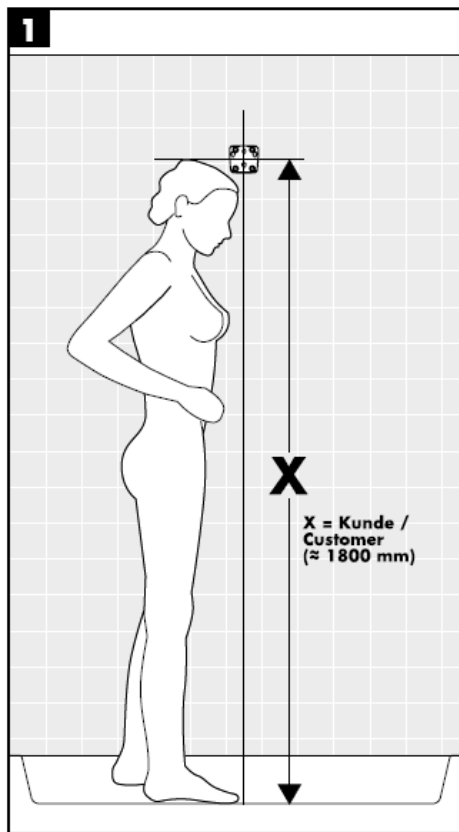

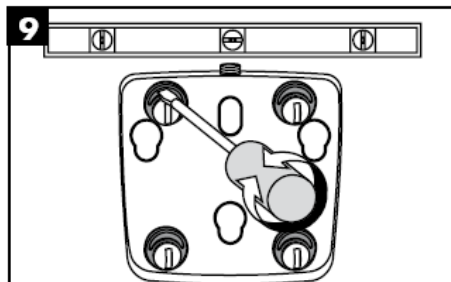
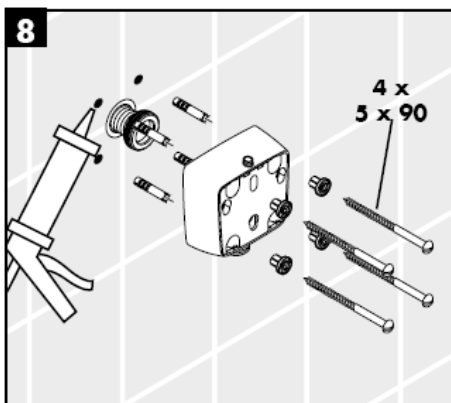
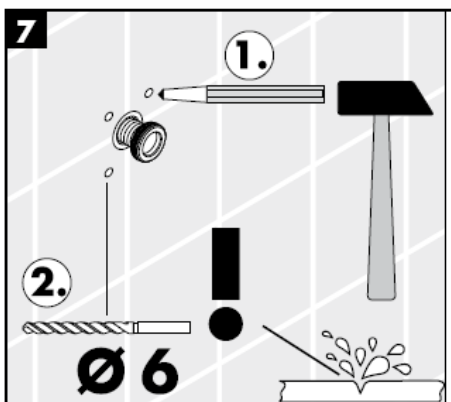
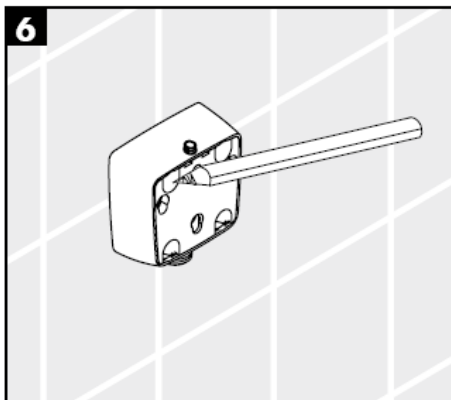

Ar ekscentra bukses palīdzību var izlīdzināt urbuma neprecizitātes.

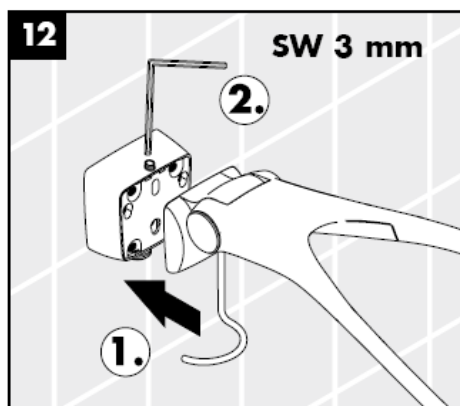
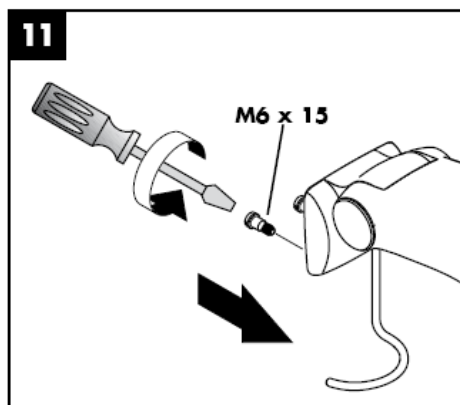
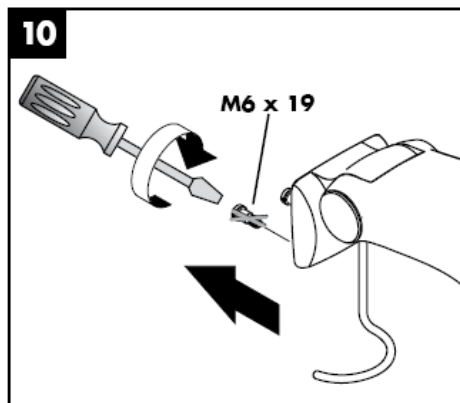



Allrounder komplekts ir daudzfunkcionāla dušas sistēma. Atkarībā no pārslēga pozīcijas var izmantot galvas vai sānu dušas funkcijas vai atsevišķi rokas dušu.

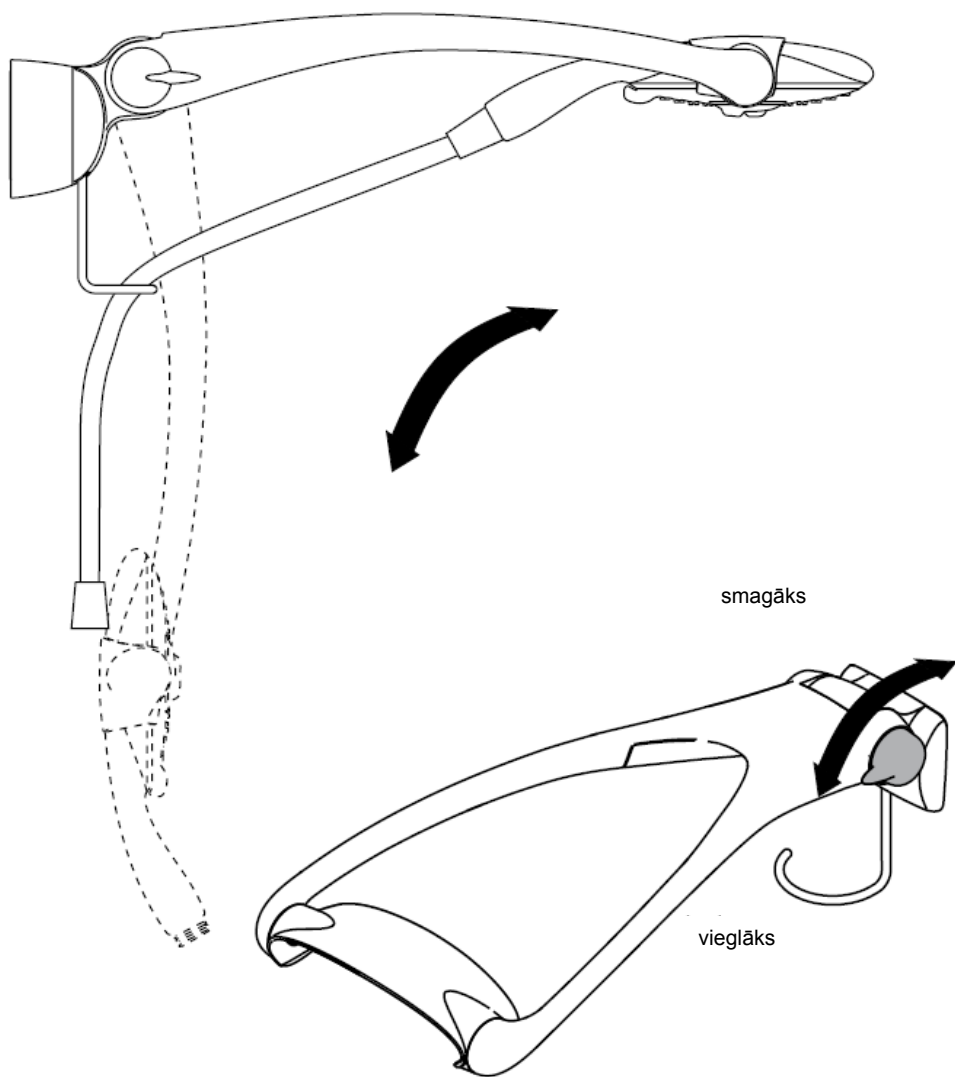

Rubit® attīrīšanas funkcija - strūklas kanāliņi vienkāršas manuālas berzes rezultātā tiek attīrīti no kaļķa.

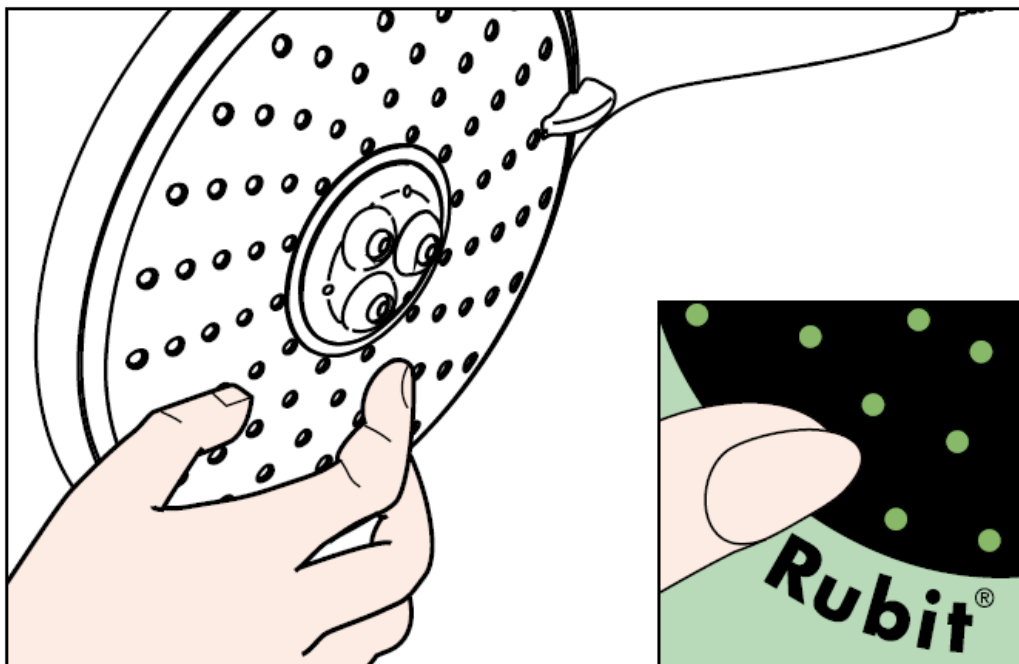

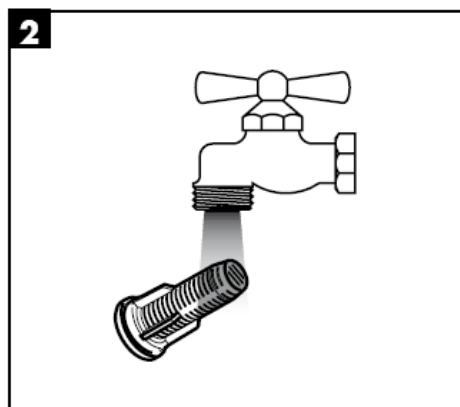
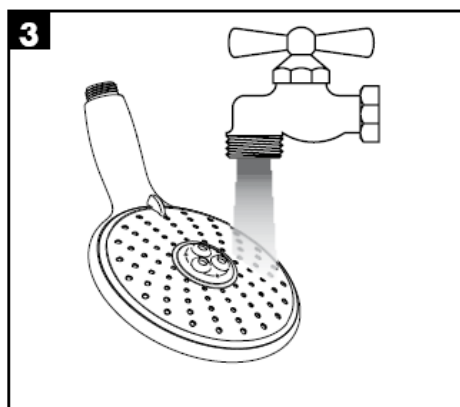
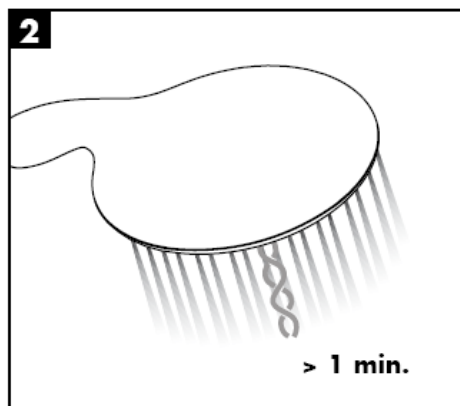
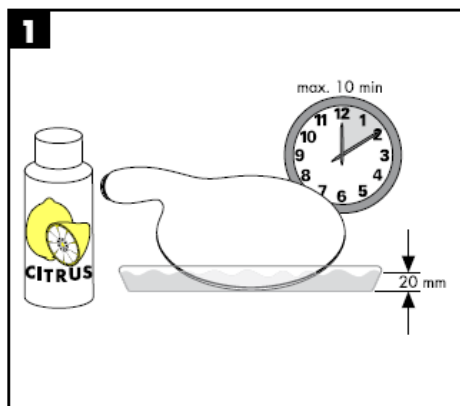

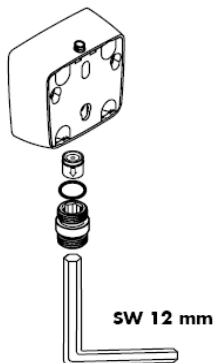

Uzmanību!

Reizi gadā jāpārbauda pretvārsti atbilstoši DIN 1988.

hansgrohe

Hansgrohe · Postfach 1145 · D-77761 Schiltach · Telefon +49 (0) 78 36/51-1282 · Telefax +49 (0) 7836/511440
E-Mail: info@hansgrohe.com · Internet: www.hansgrohe.com

02/2008
9.06081.04
Latviski

Uputstvo za montažu

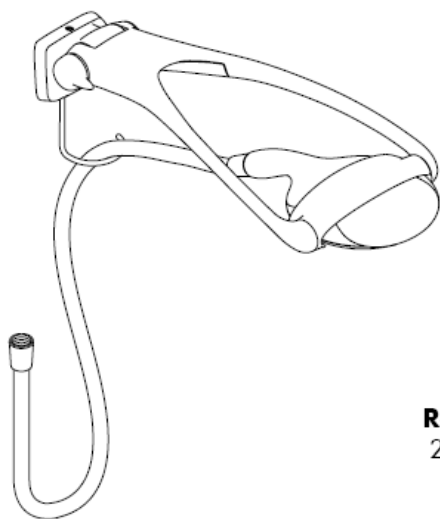

Raindance
28105000

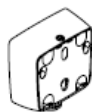

Raindance
28108000

Raindance Allrounder Set
28100000 / 28110000

hansgrohe

Raindance Allrounder Set

28100000 / 28110000

Classification acoustique et débit 28110000: ACS

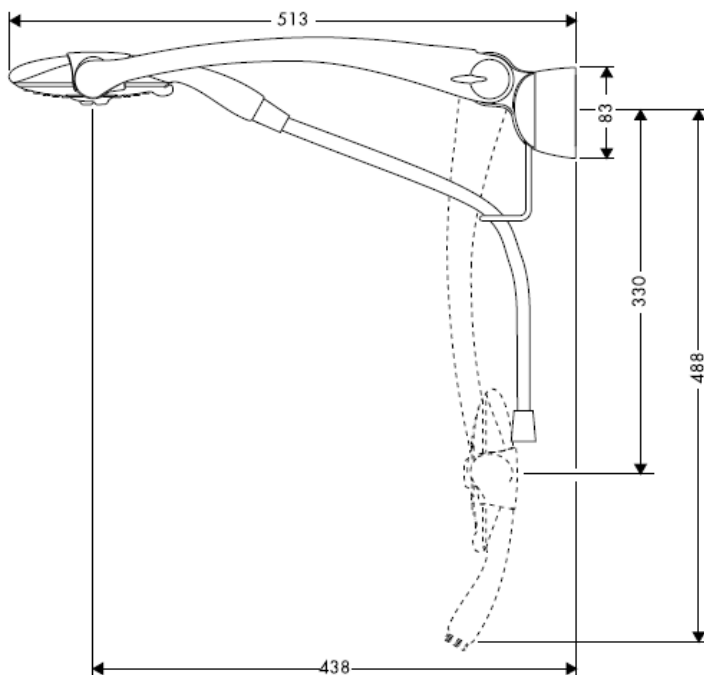

Raindance Eckmontage Set

28105000



Raindance UP-Adapter für Schlauchanschluß

28108000



Raindance Allrounder Set

28100000 / 28110000

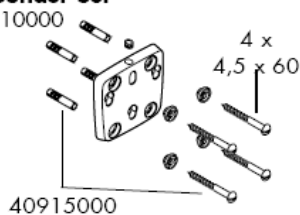

98562000

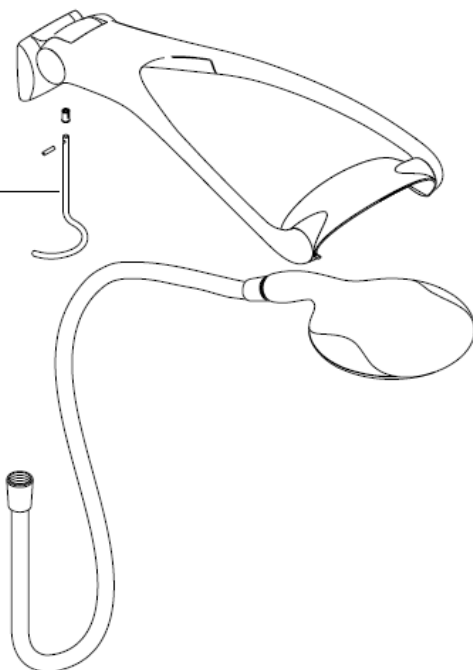

Raindance Eckmontage Set

28105000

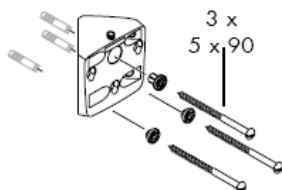

Raindance UP-Adapter für Schlauchanschluss

28108000

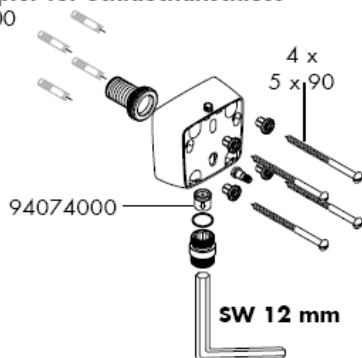

Montaža

Isporučeni umetak filtra (A) se mora ugraditi kako bi se regulisao protok vode i smanjio prolazak prljavštine iz vodovoda. Ako želite jači protok vode, umesto filtra (A) ugradite mrežastu zaptivku (B). Za eventualna oštećenja ili lošije funkcionisanje ručnog tuša uzrokovano prljavštinom, proizvođač Hansgrohe nije odgovoran.

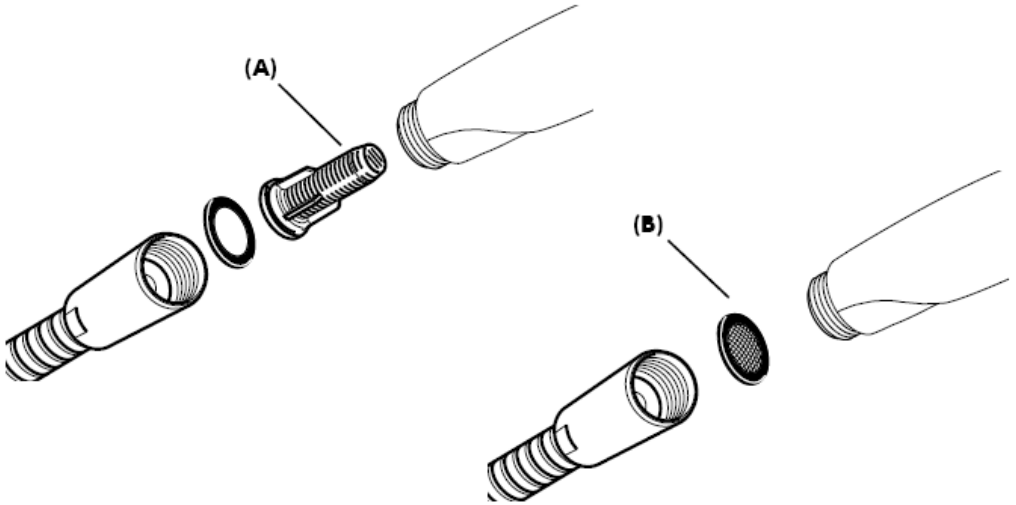

281000000

S filterom (A)

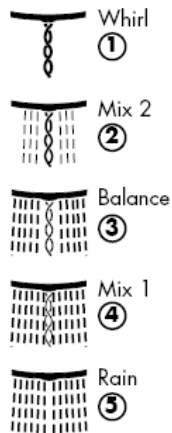
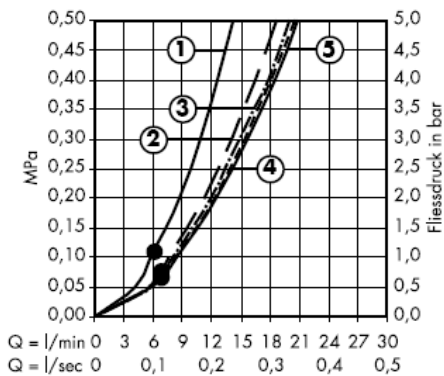

S mrežastom zaptivkom (B)

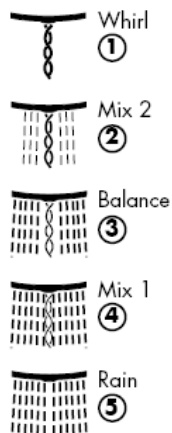
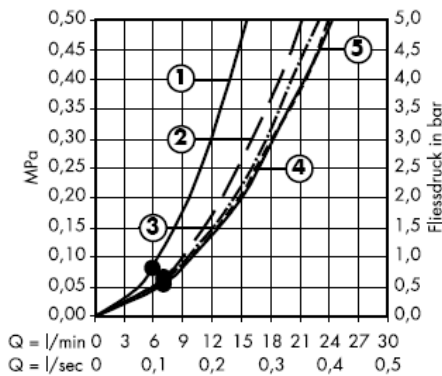

Od • je funkcija zagantovana.

S filterom (A)

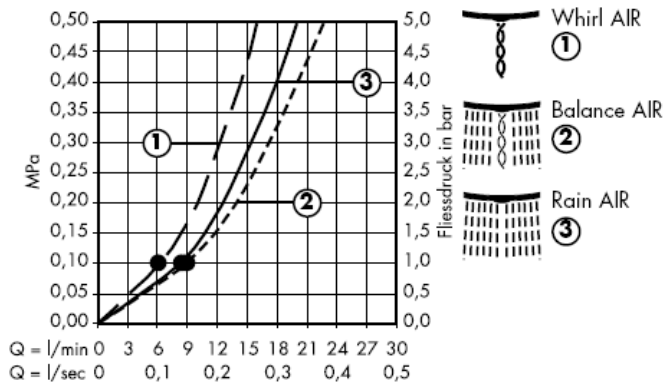

S mrežastom zaptivkom (B)

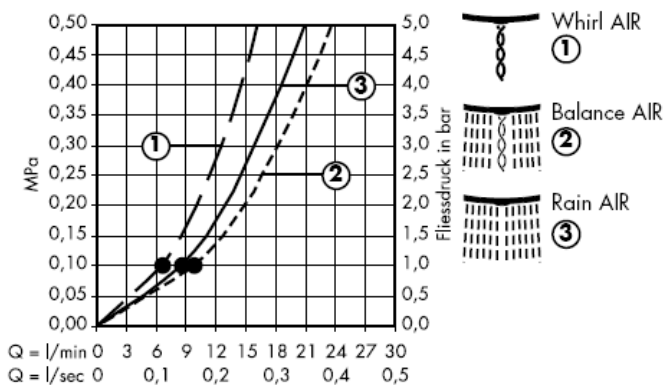

Od • je funkcija zagantovana.

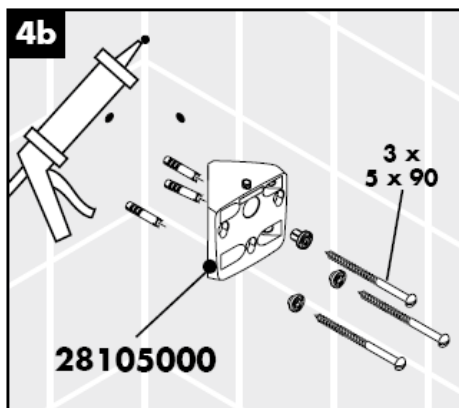
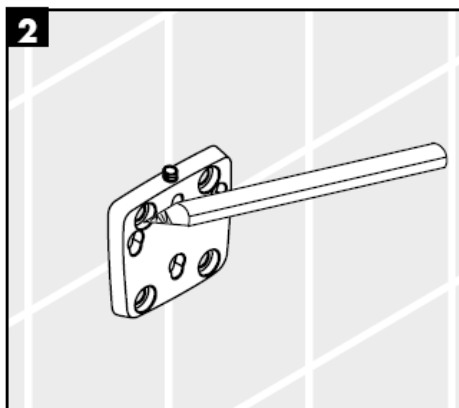

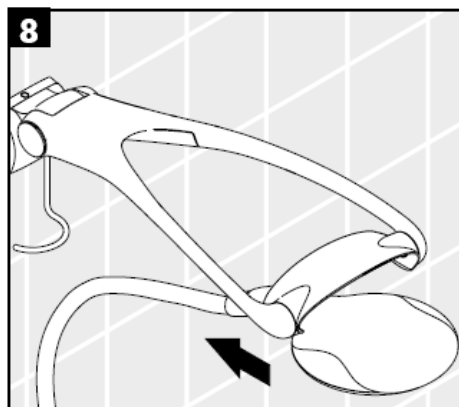
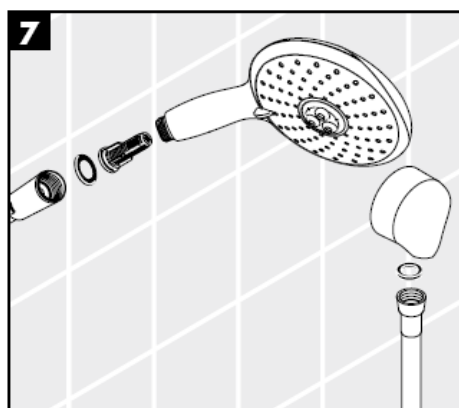
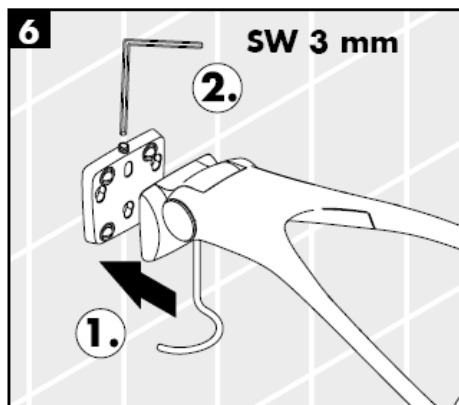

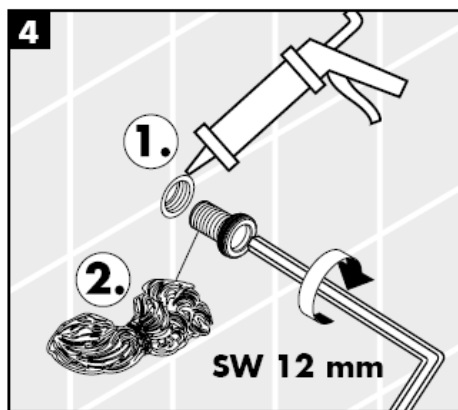
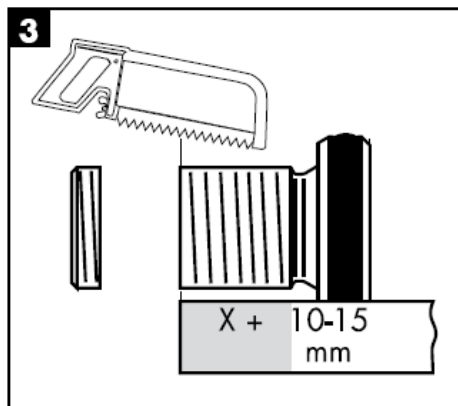
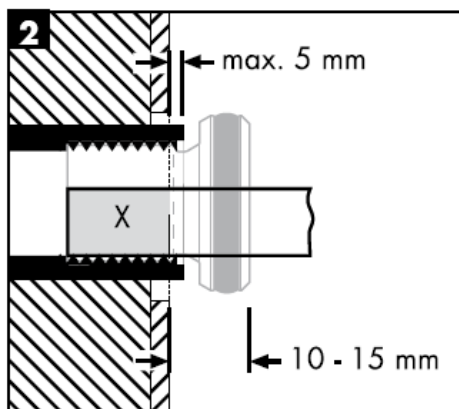
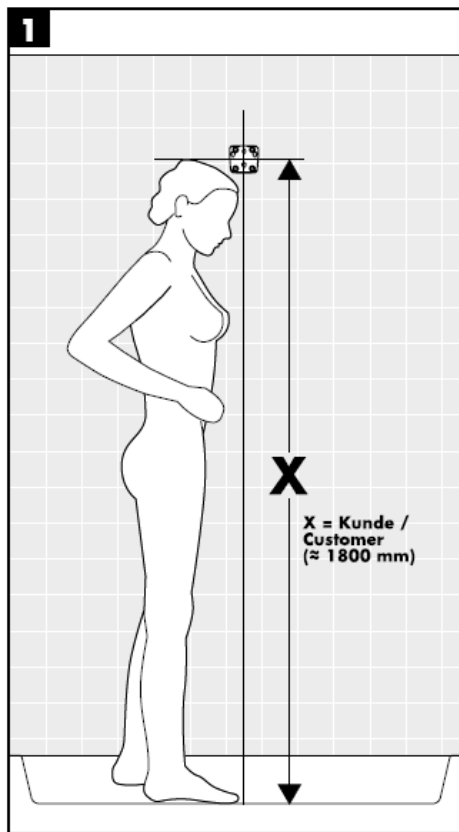

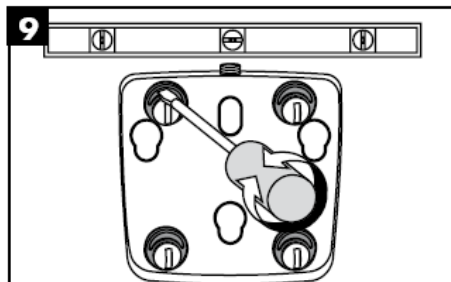
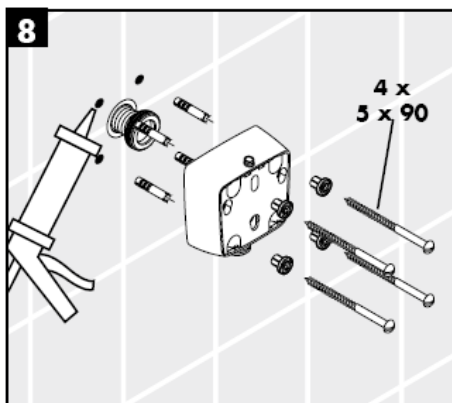
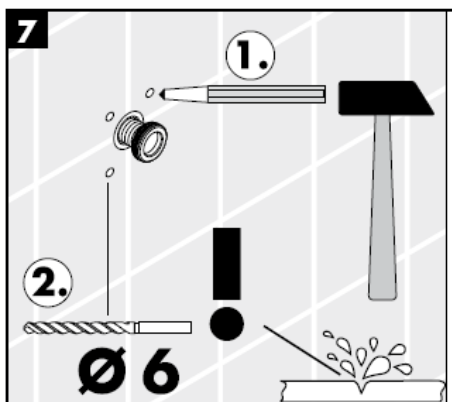
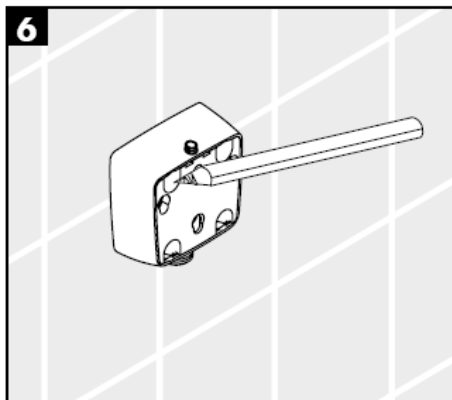

Pomoću ekscentara mogu se podesiti tolerancije provrta.





Allrounder set je multifunkcionalni sistem tuševa. Več prema poziciji držača, može se koristiti bočno ili prskanje iznad glave, odnosno poseban ručni tuš.

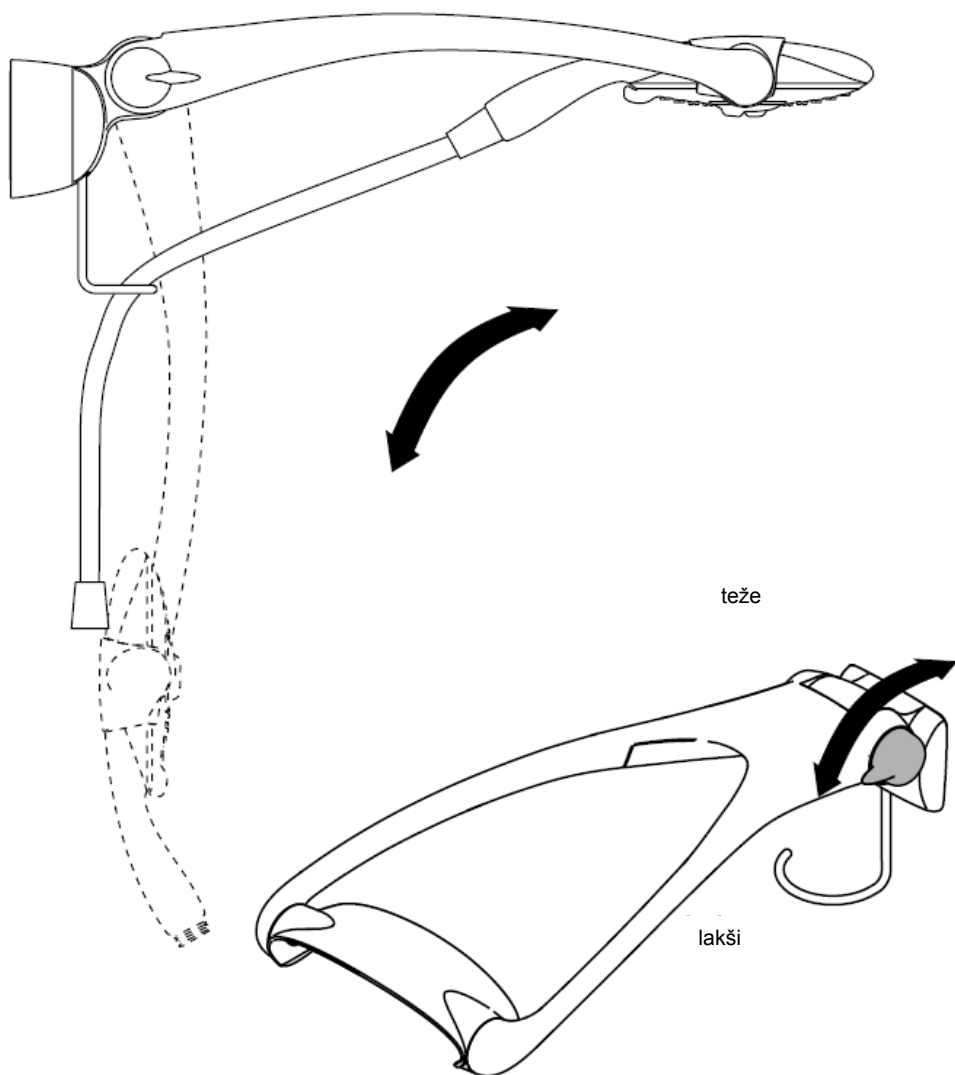

Čišćenje

Rubit® - ručni sistem za čišćenje omogućuje odstranjivanje kamenca s rupica uobličavača mlaza, jednostavnim trljanjem.

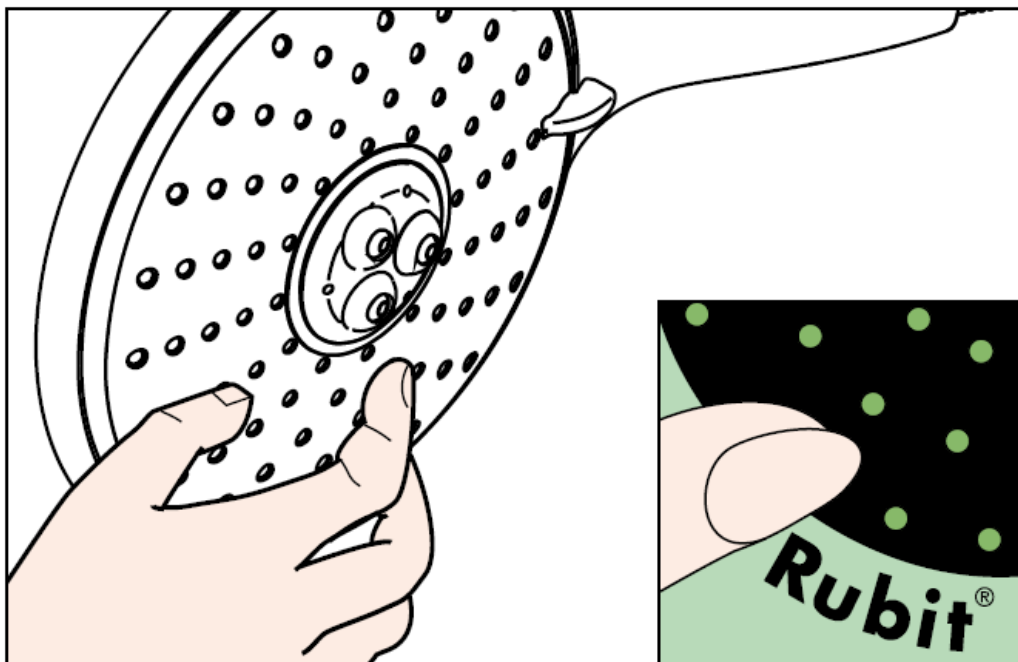

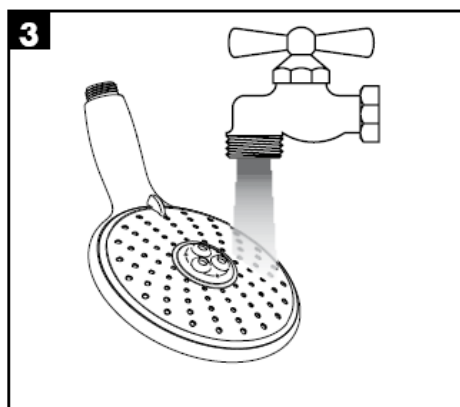
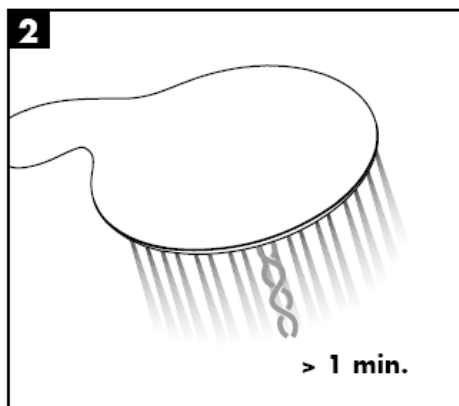
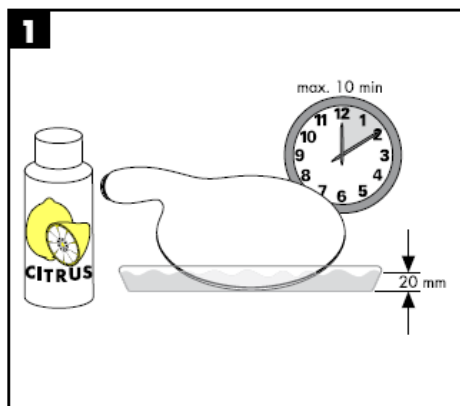

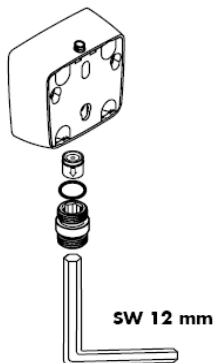

Pažnja!

Nepovratni ventil se mora proveravati jednom godišnje prema standardu DIN 1988.

hansgrohe

Hansgrohe · Postfach 1145 · D-77761 Schiltach · Telefon +49 (0) 78 36/51-1282 · Telefax +49 (0) 7836/511440
E-Mail: info@hansgrohe.com · Internet: www.hansgrohe.com

02/2008
9.06081.04
Srpski

Montasjeveiledning

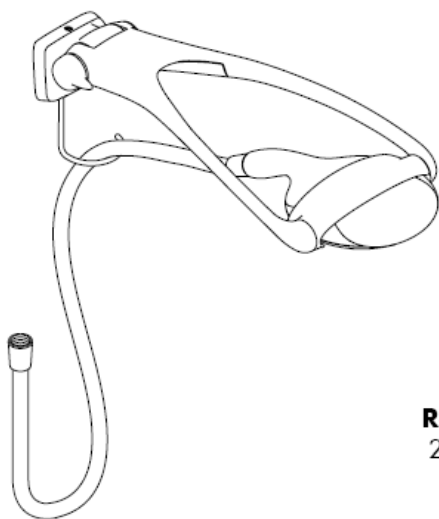

Raindance
28105000

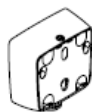

Raindance
28108000

Raindance Allrounder Set
28100000 / 28110000

hansgrohe

Raindance Allrounder Set

28100000 / 28110000

Classification acoustique et débit 28110000: ACS

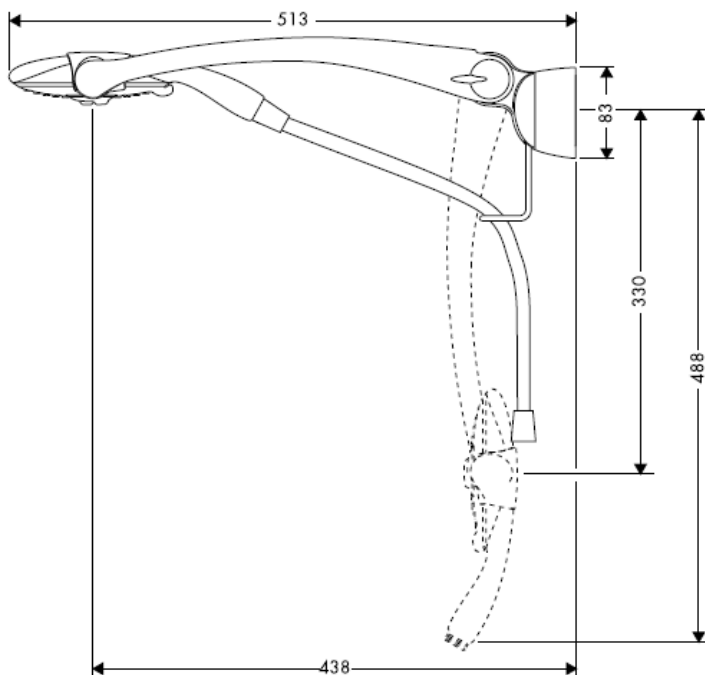

Raindance Eckmontage Set

28105000



Raindance UP-Adapter für Schlauchanschluß

28108000



Raindance Allrounder Set

28100000 / 28110000

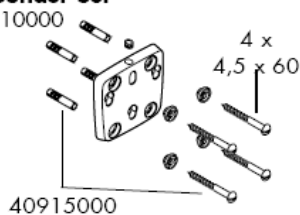

98562000

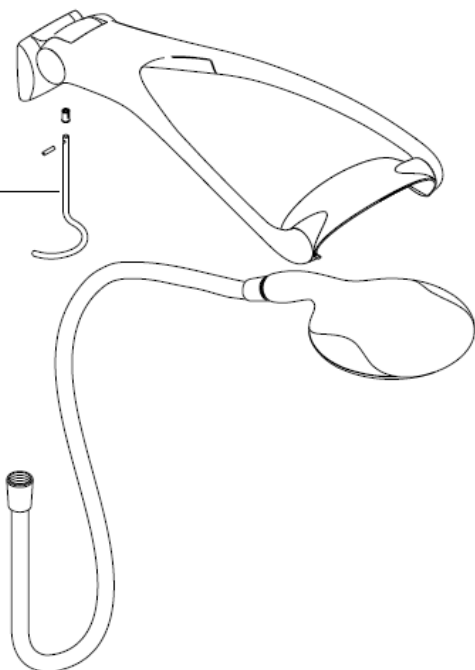

Raindance Eckmontage Set

28105000

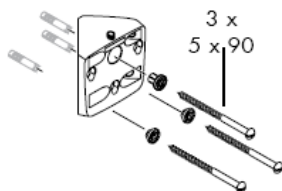

Raindance UP-Adapter für Schlauchanschluss

28108000

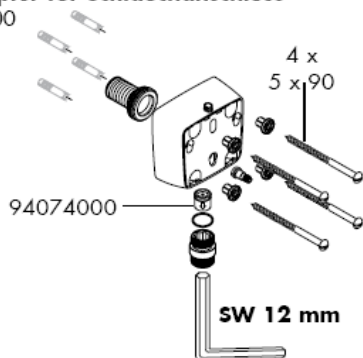

Montasje

Det medleverte filter-elementet skal bygges inn, for å garantere hånddusjens standard-gjennomstrømning og for å forhindre at smuss spyles inn fra ledningsnettet. Ønsker man en større vanngjennomstrømning skal det monteres en silpakning (B) isteden for filterelementet (A). Innspyling av smuss kan påvirke funksjonen negativt og/eller medføre skader på hånddusjens funksjonsdeler. Hansgrohe påtar seg inget ansvar for skader som resulteres av dette.

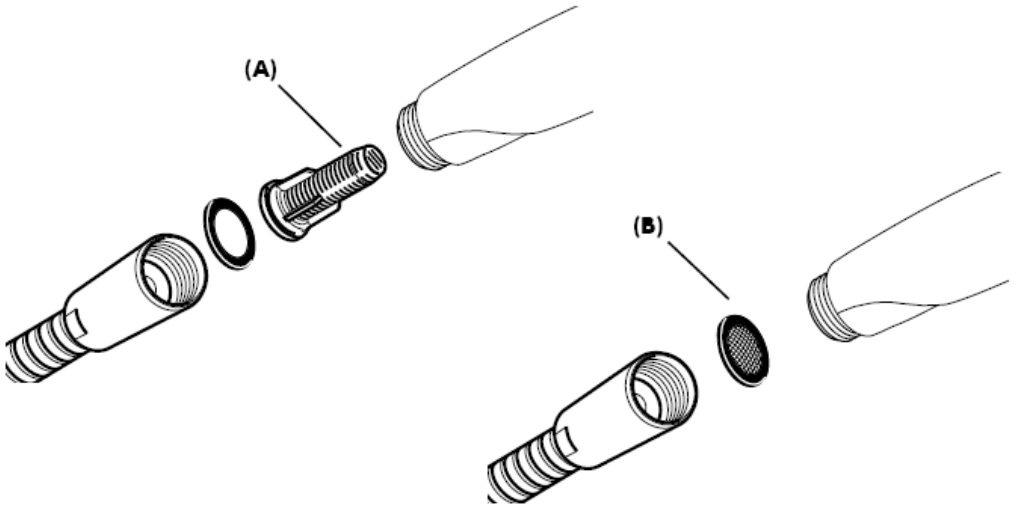

281000000

Med filterinnsats (A)

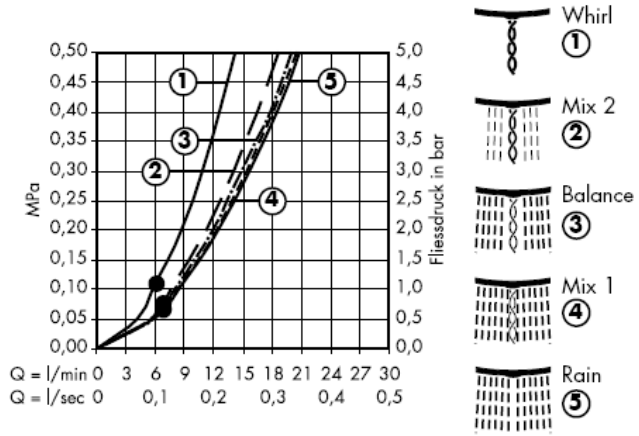

Med silpakning (B)

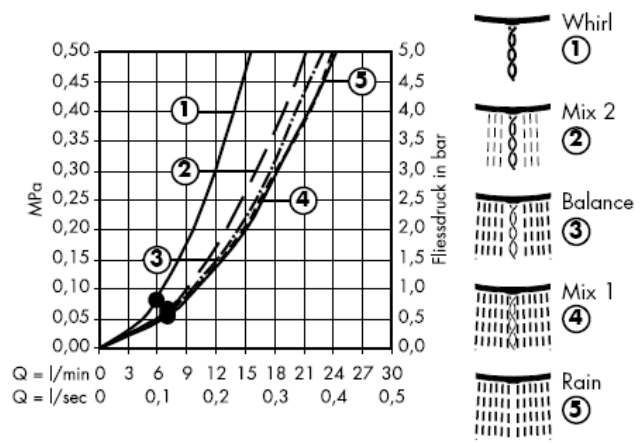

F.o.m. • er funksjonen garantert

Med filterinnsats (A)

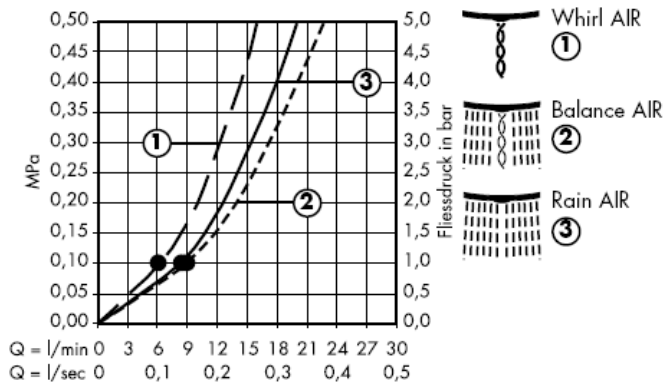

Med silpakning (B)

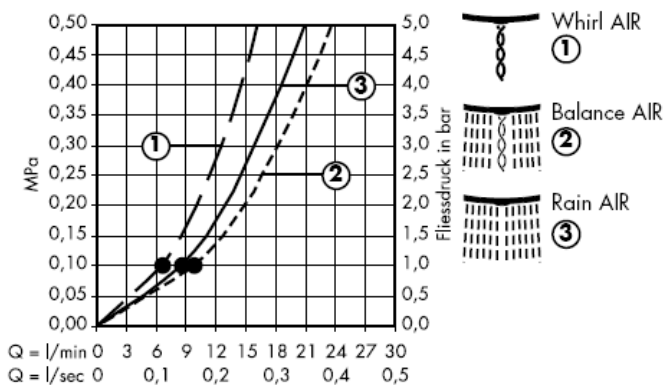

F.o.m. • er funksjonen garantert

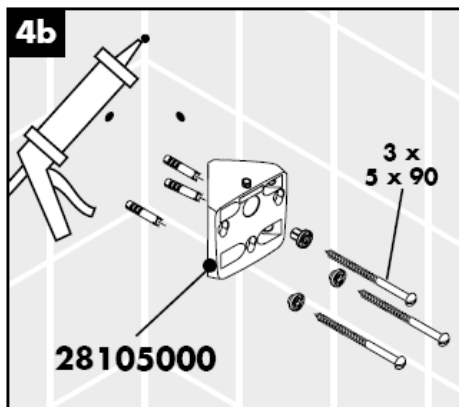
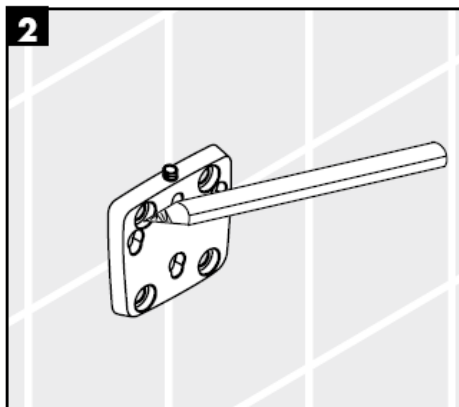

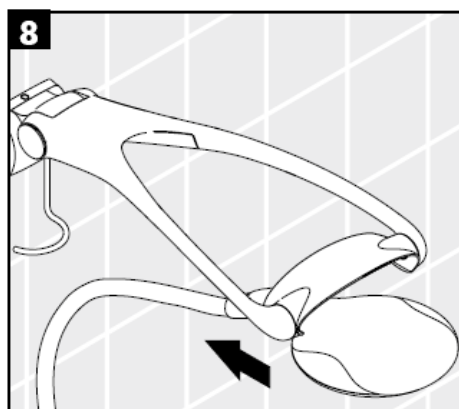
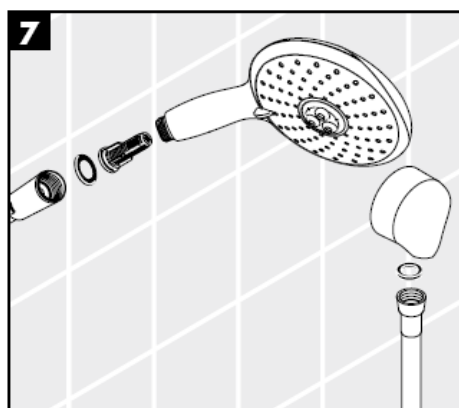
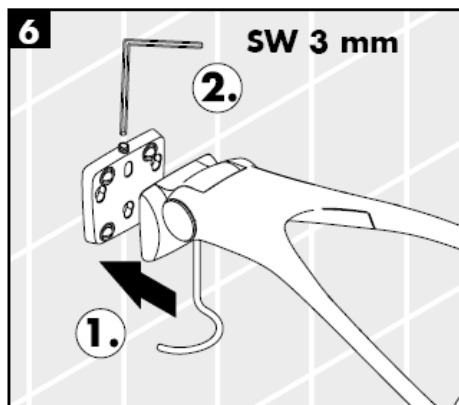

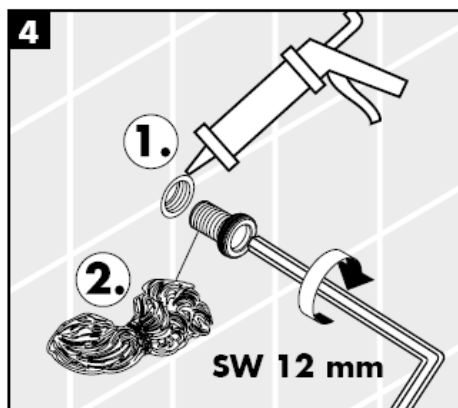
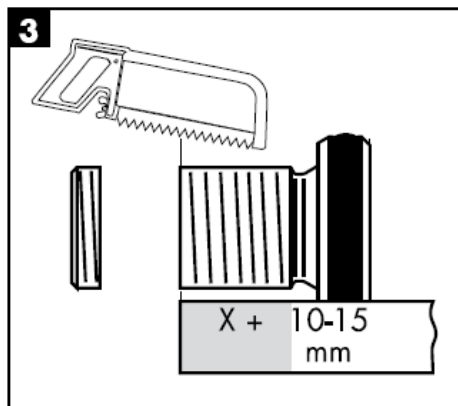
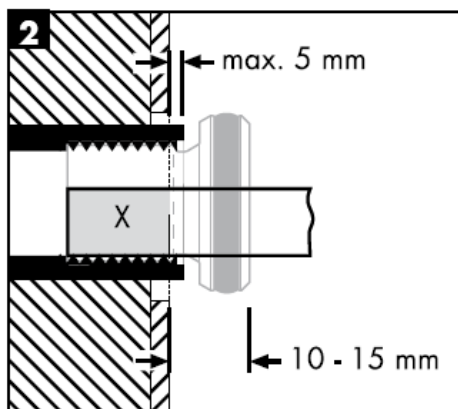
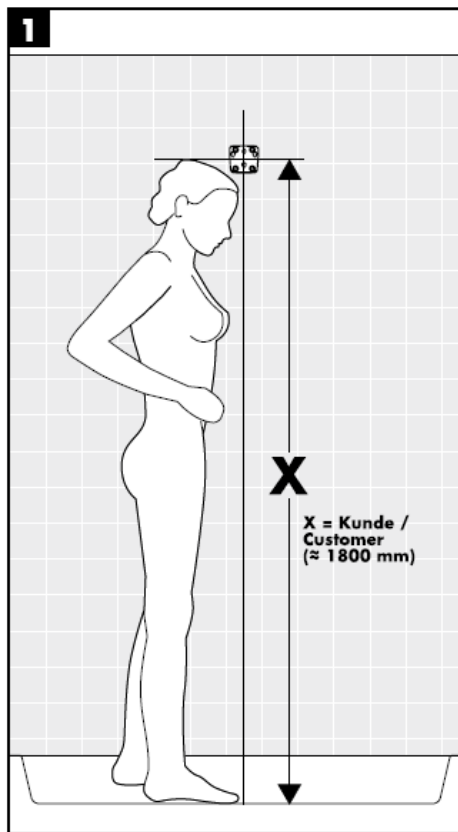

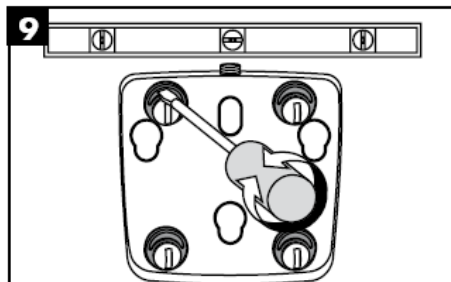
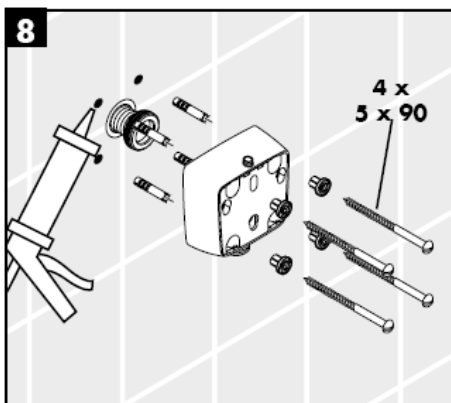
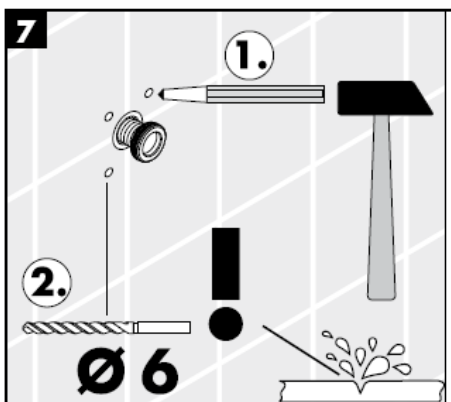
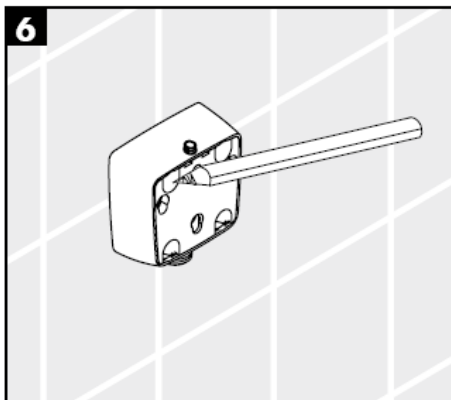

Boretoleranser kan utlignes ved hjelp av eksenterbøssing.





Allrounder settet er et multifunksjonalt dusjsystem. Alt etter stilling av bøylen kan man bruke hode- eller sidefunksjonene hhv. den separate hånddusjen.

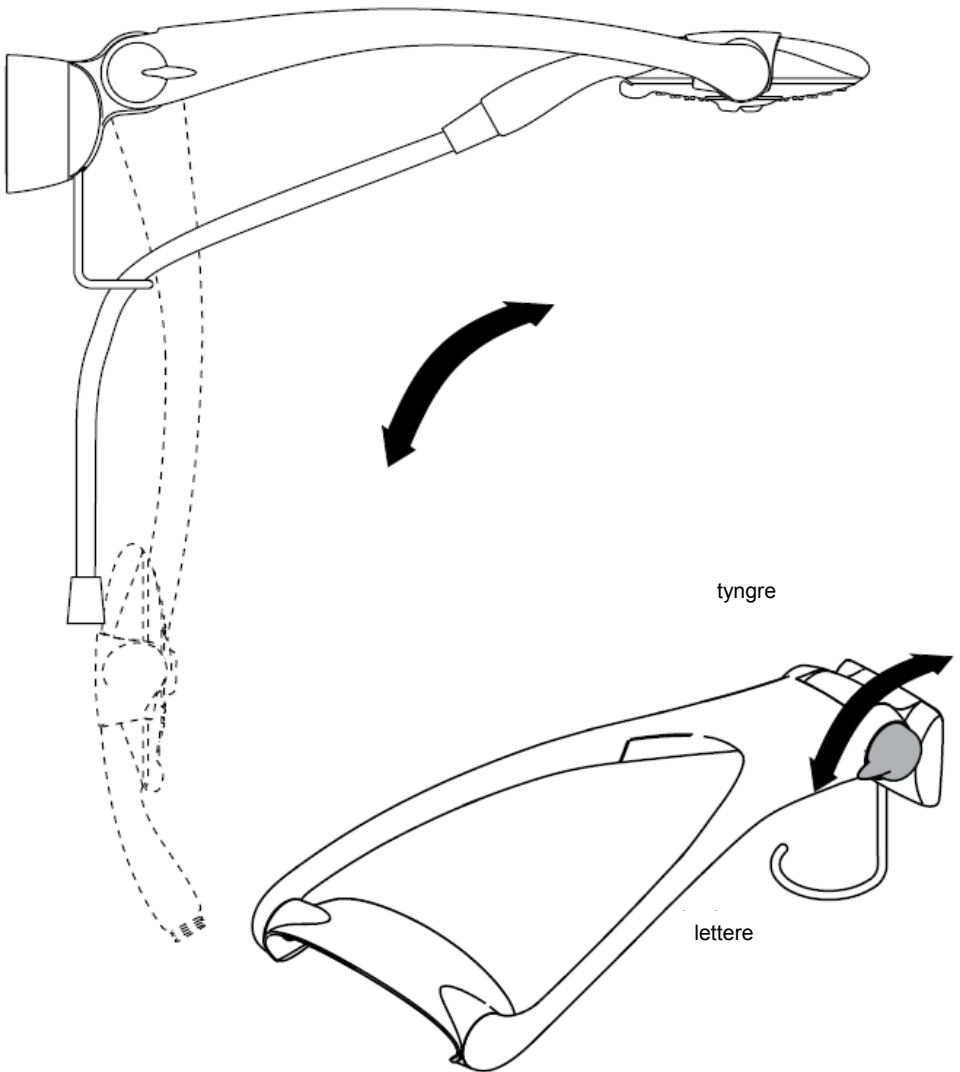

Rengjøring

Ved hjelp av Rubit®, en manuell rengjøringsfunksjon, kan man fjerne kalk fra stråleformere ved enkel gnikking.

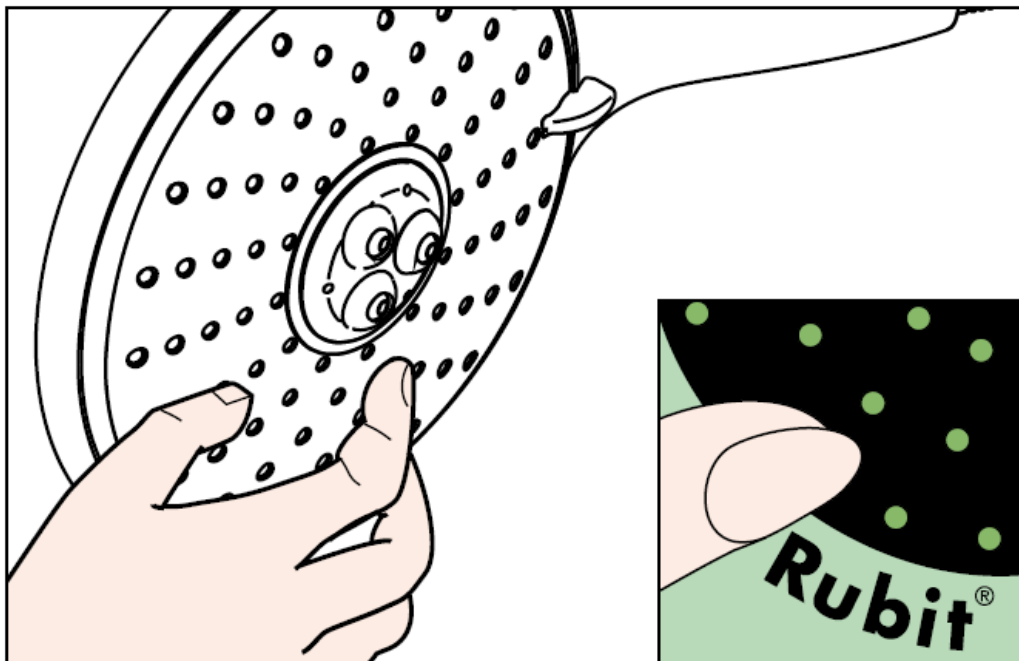

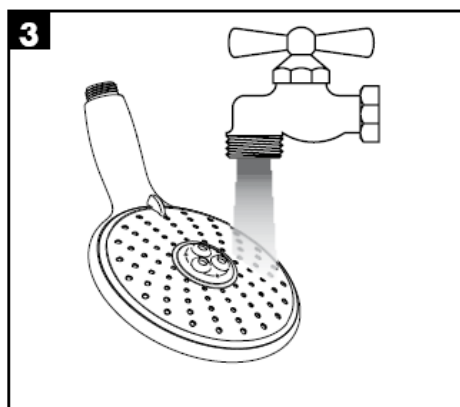
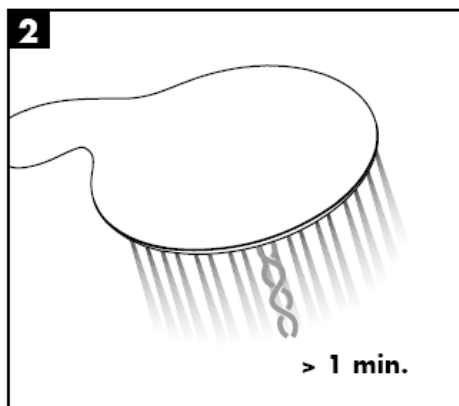
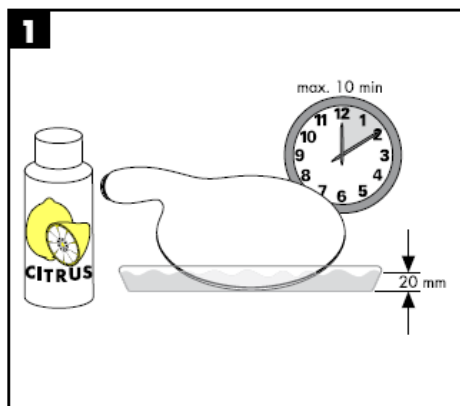

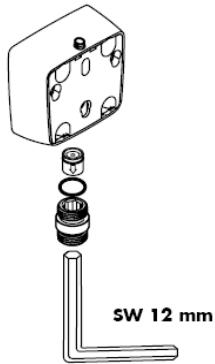

Obs!

I henhold til DIN 1988 skal funksjonen til returløpssperren sjekkes en gang i året.

hansgrohe

Hansgrohe · Postfach 1145 · D-77761 Schiltach · Telefon +49 (0) 78 36/51-1282 · Telefax +49 (0) 7836/511440
E-Mail: info@hansgrohe.com · Internet: www.hansgrohe.com

02/2008
9.06081.04
Norsk

РЪКОВОДСТВО ЗА МОНТАЖ

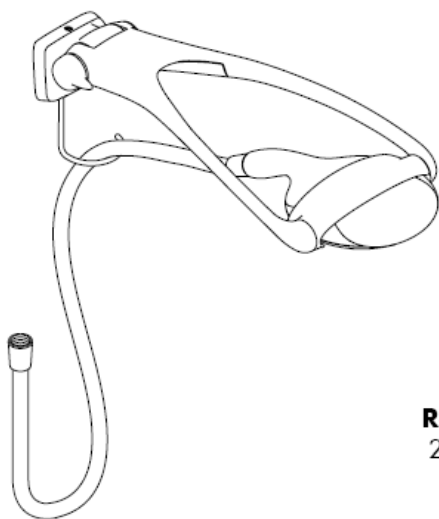

Raindance
28105000

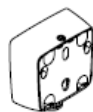

Raindance
28108000

Raindance Allrounder Set
28100000 / 28110000

hansgrohe

Raindance Allrounder Set

28100000 / 28110000

Classification acoustique et débit 28110000: ACS

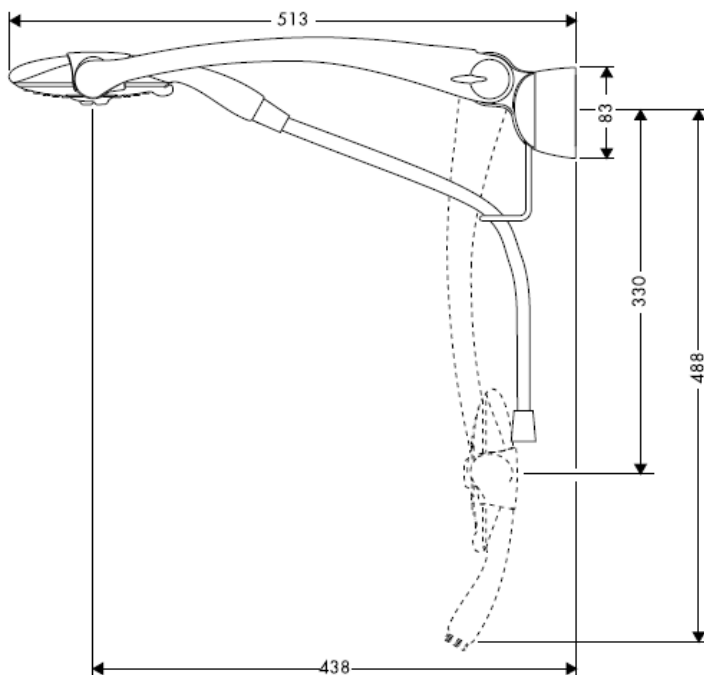

Raindance Eckmontage Set

28105000



Raindance UP-Adapter für Schlauchanschluß

28108000



Raindance Allrounder Set

28100000 / 28110000

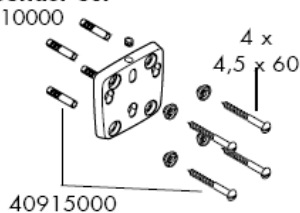

98562000

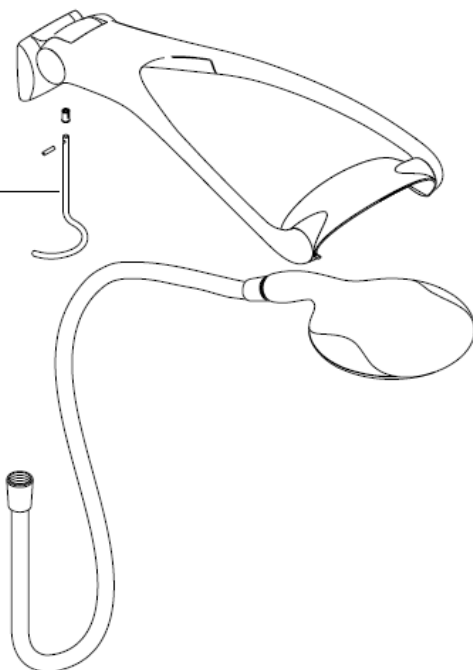

Raindance Eckmontage Set

28105000

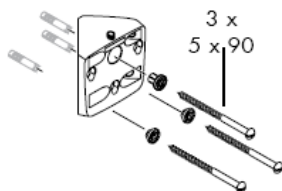

Raindance UP-Adapter für Schlauchanschluss

28108000

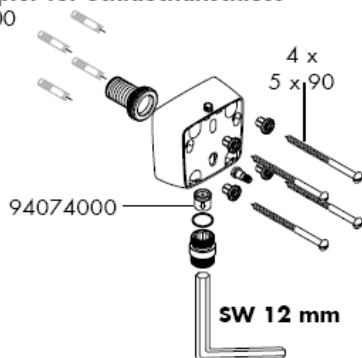

Монтаж

Опакованата към него филтърна вложка (А) трябва да се монтира, за да се осигури нормалния поток към ръчния разпръсквател и да се избегне натрупване на замърсявания от водопроводната мрежа. Ако желаете по-силно протичане на вода, вместо филтърната вложка (А) поставете уплътнението с цедка (В). Натрупването на замърсявания може да наруши функцията и/или да доведе до увреждания на функционалните части на ръчния разпръсквател, Hansgrohe не носи отговорност за получените се по този начин щети.

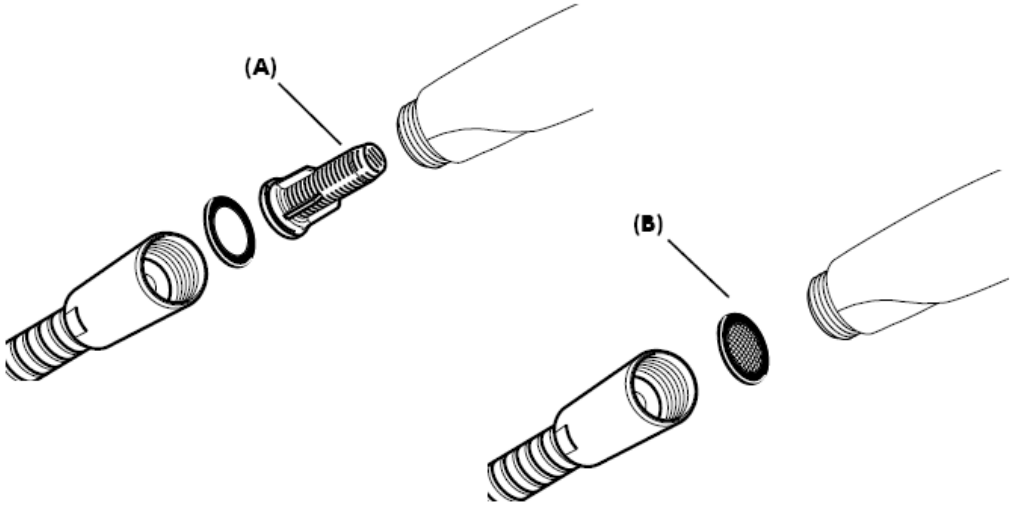

С филтърна вложка (А)

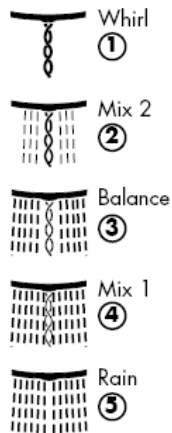
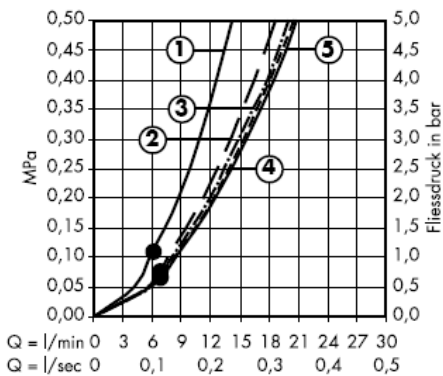

С уплътнение с цедка (B)

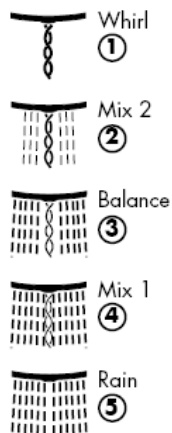
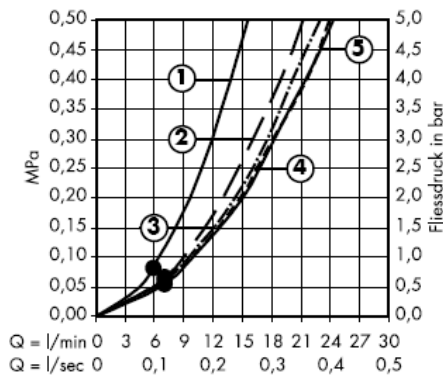

От • функцията е гарантирана.

С филтърна вложка (A)

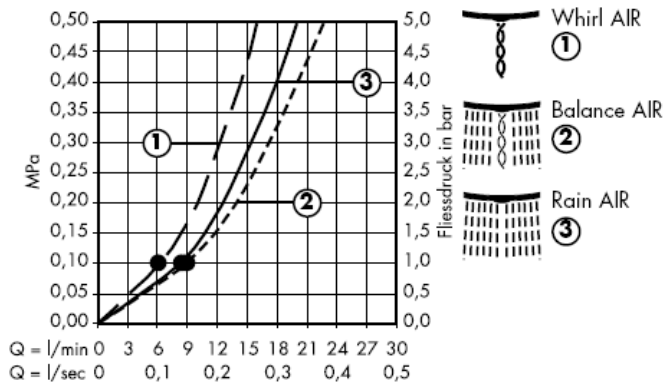

С уплътнение с цедка (B)

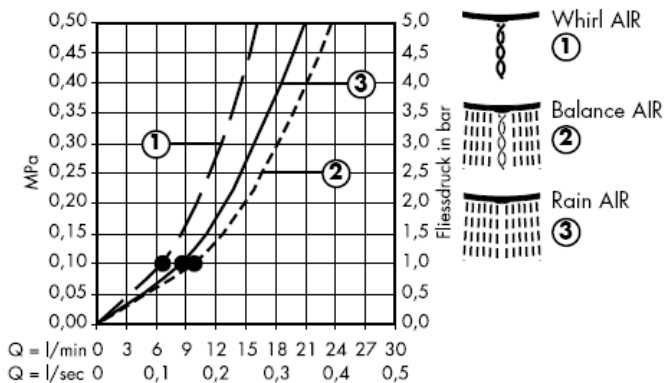

От • функцията е гарантирана.

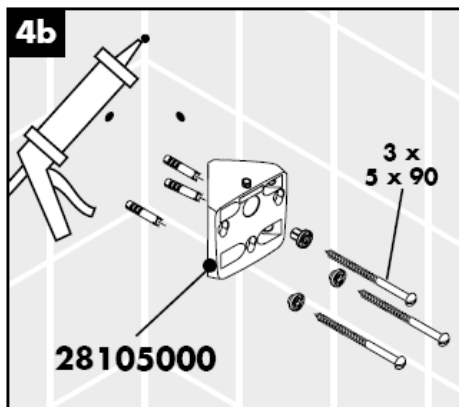
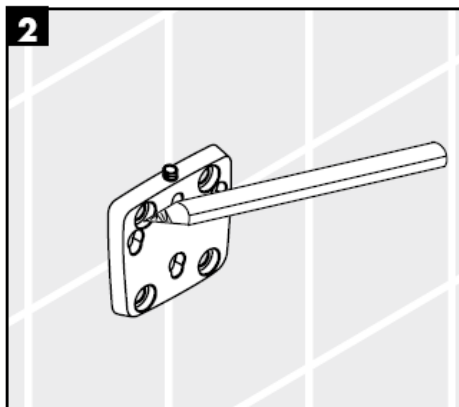

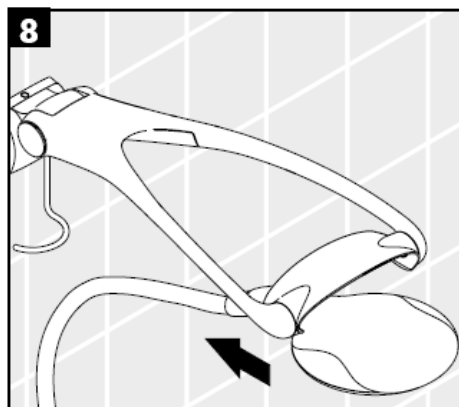
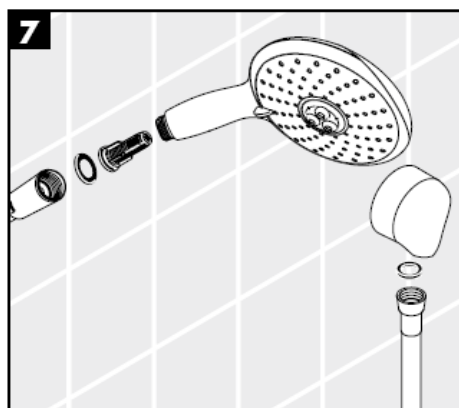
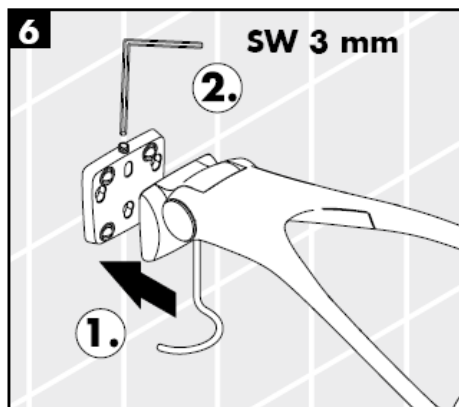

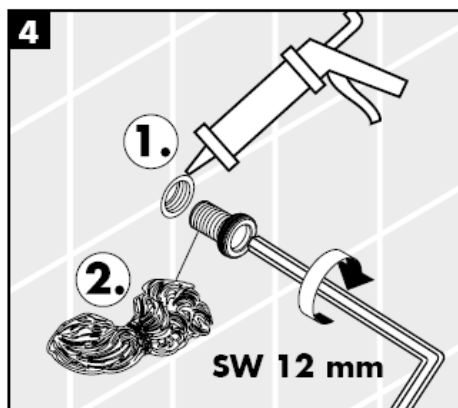
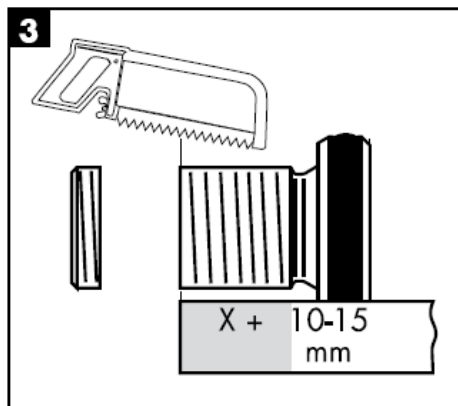
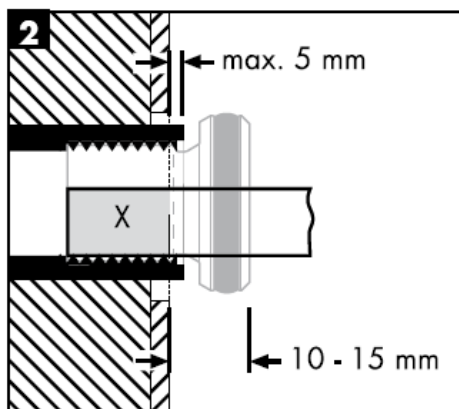
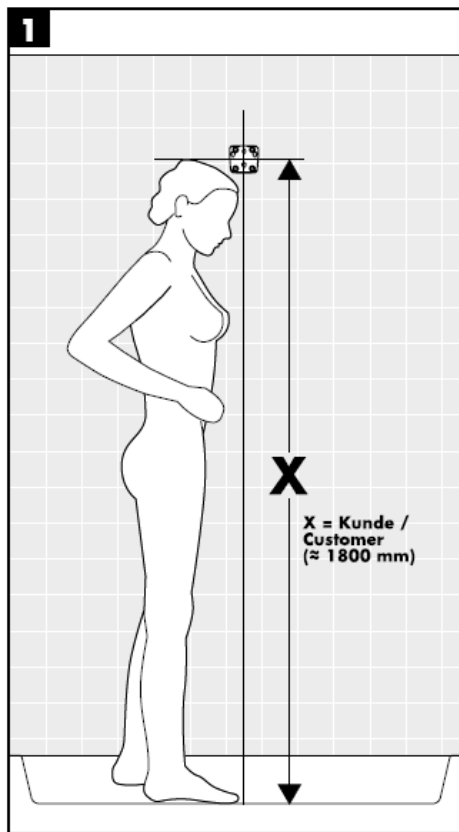

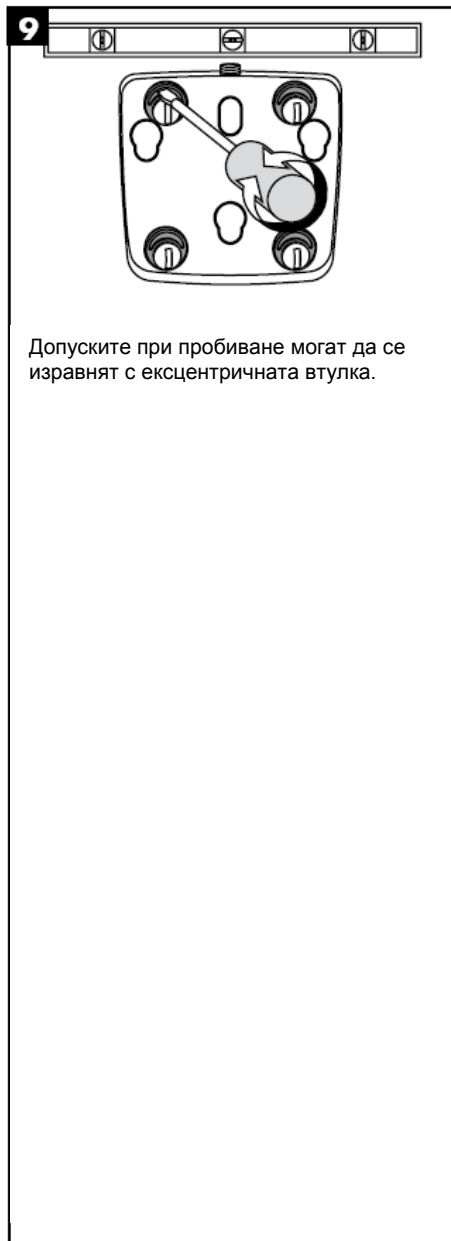
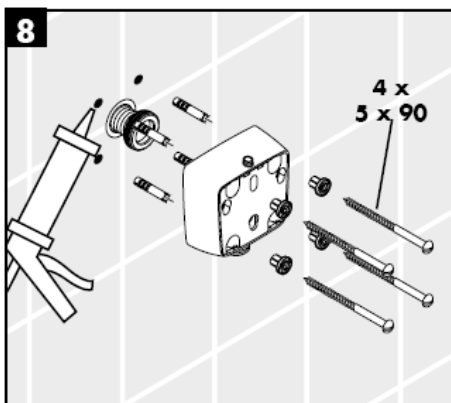
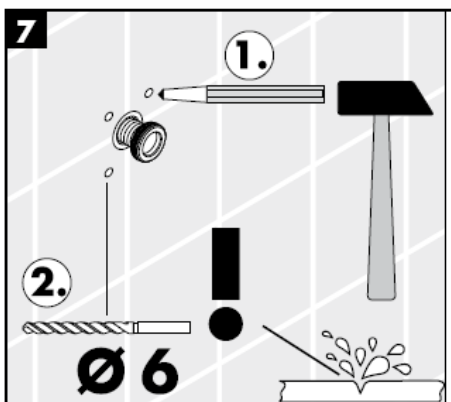
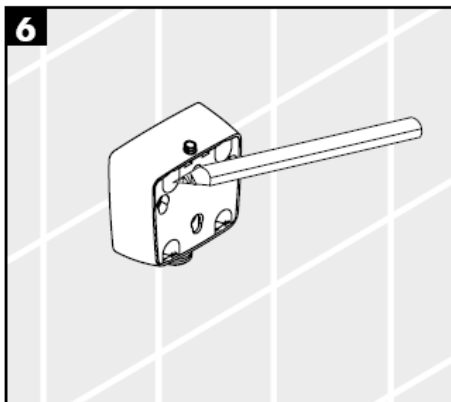

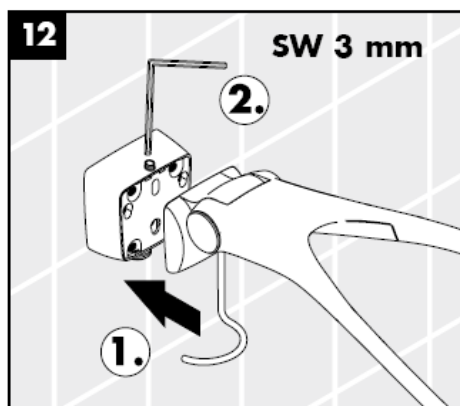
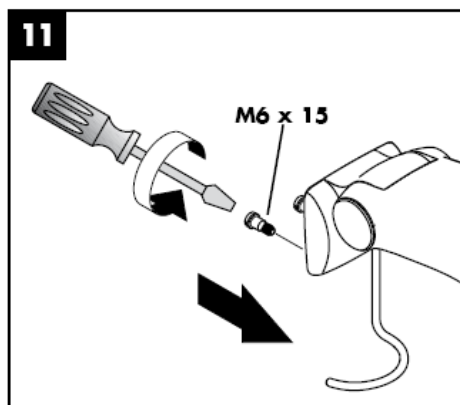
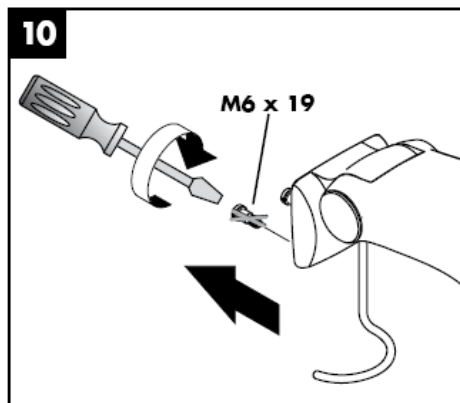

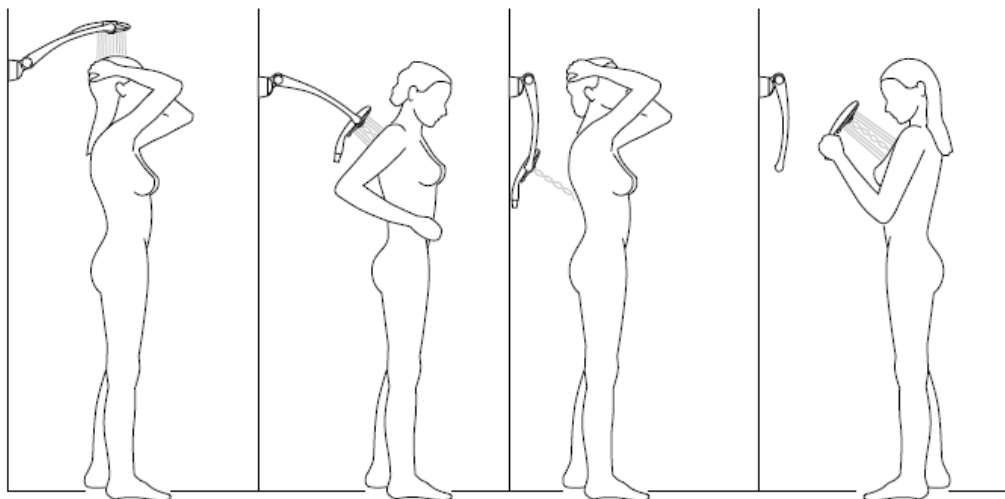

Allrounder Set (универсален набор) е мултифункционална система разпръскватели. Според положението на скобата могат да се използват функциите на разпръсквателя за главата или на страничния разпръсквател респ. на отделния ръчен разпръсквател.

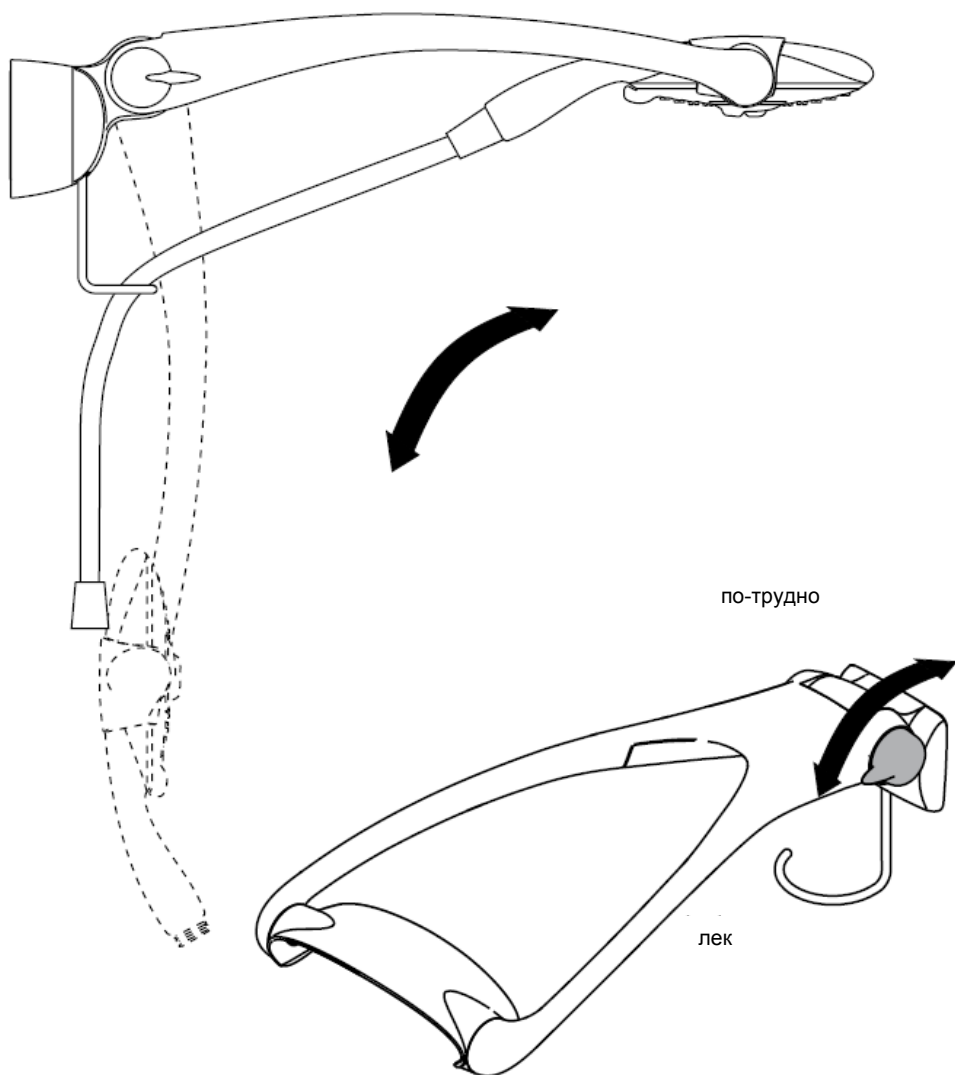

С Rubit®, ръчната функция за почистване, приспособленията за почистване на струята могат да се почистват от варовика с просто разтъркване.

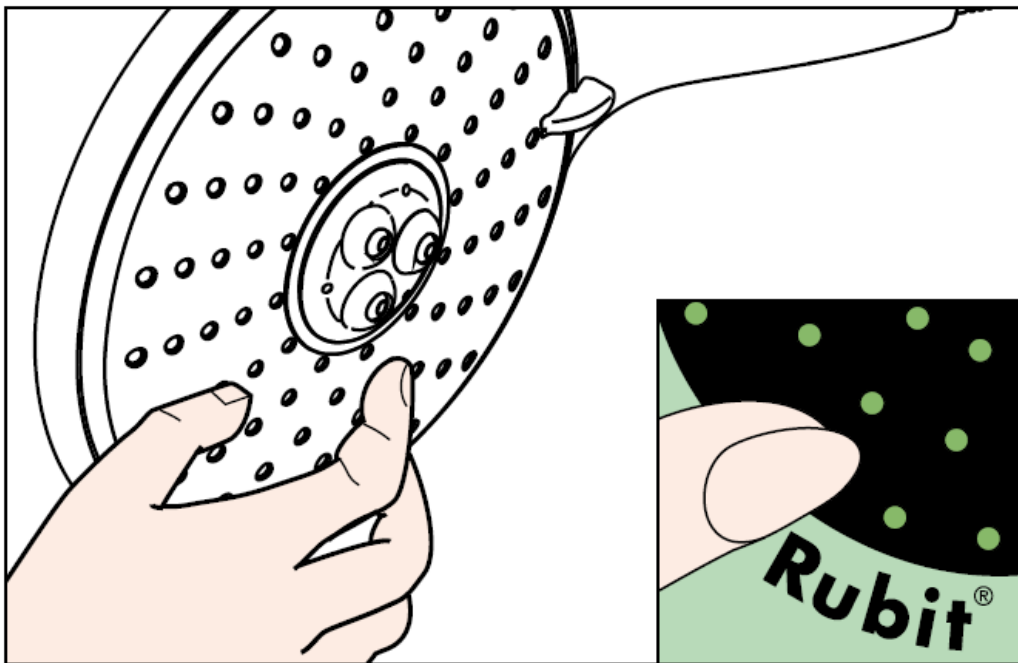

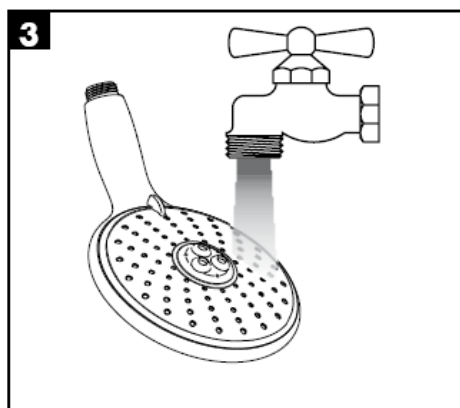
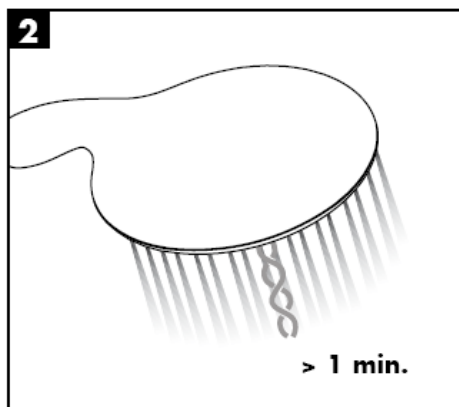
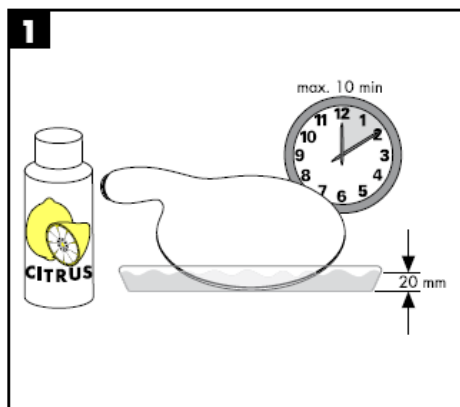

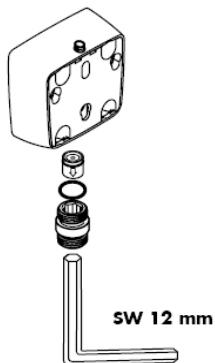

Внимание!

Съгласно DIN 1988 веднъж годишно трябва да се проверява функцията на приспособленията, предотвратяващи обратния поток.

hansgrohe

Hansgrohe · Postfach 1145 · D-77761 Schiltach · Telefon +49 (0) 78 36/51-1282 · Telefax +49 (0) 7836/511440
E-Mail: info@hansgrohe.com · Internet: www.hansgrohe.com

02/2008
9.06081.04
БЪЛГАРСКИ

Udhëzime rreth montimit

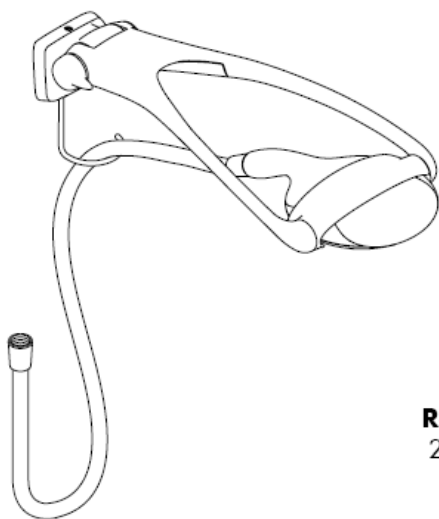

Raindance
28105000

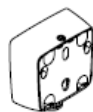

Raindance
28108000

Raindance Allrounder Set
28100000 / 28110000

hansgrohe

Raindance Allrounder Set

28100000 / 28110000

Classification acoustique et débit 28110000: ACS

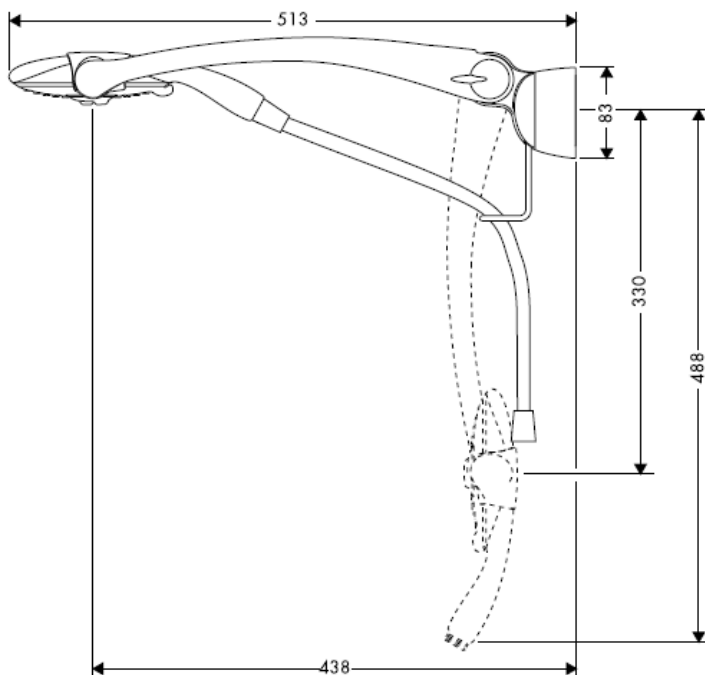

Raindance Eckmontage Set

28105000



Raindance UP-Adapter für Schlauchanschluß

28108000



Raindance Allrounder Set

28100000 / 28110000

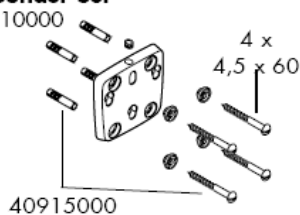

98562000

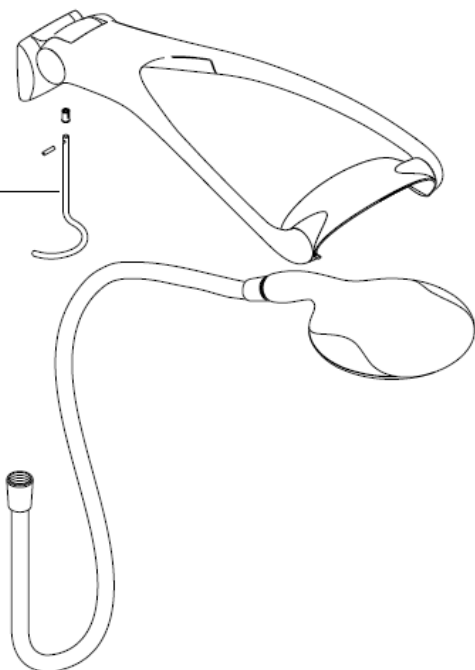

Raindance Eckmontage Set

28105000

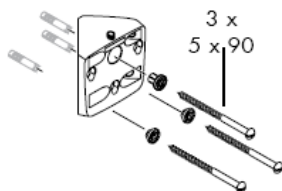

Raindance UP-Adapter für Schlauchanschluss

28108000

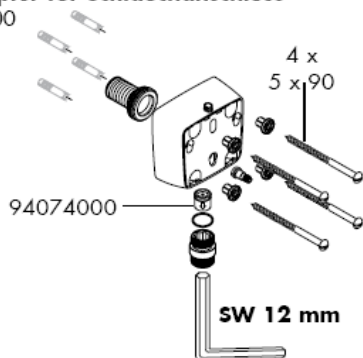

Montimi

Filtri i bashkëngjitur (A) duhet montuar për të garantuar rrjedhjen sipas normave të ujit nga spërkatësja si dhe për të evituar thithjen e ndotjeve nga tubacionet e ujësjellësit. Nëse dëshironi më shumë vëllim uji, atëherë në vend të filtrit (A) duhet të përdorni sitën (B).

Ndotjet mund të dëmtojnë pjesë funksionale të spërkatësës. Hansgrohe nuk merr përgjegjësinë për dëmet e shkaktuara në këtë mënyrë.

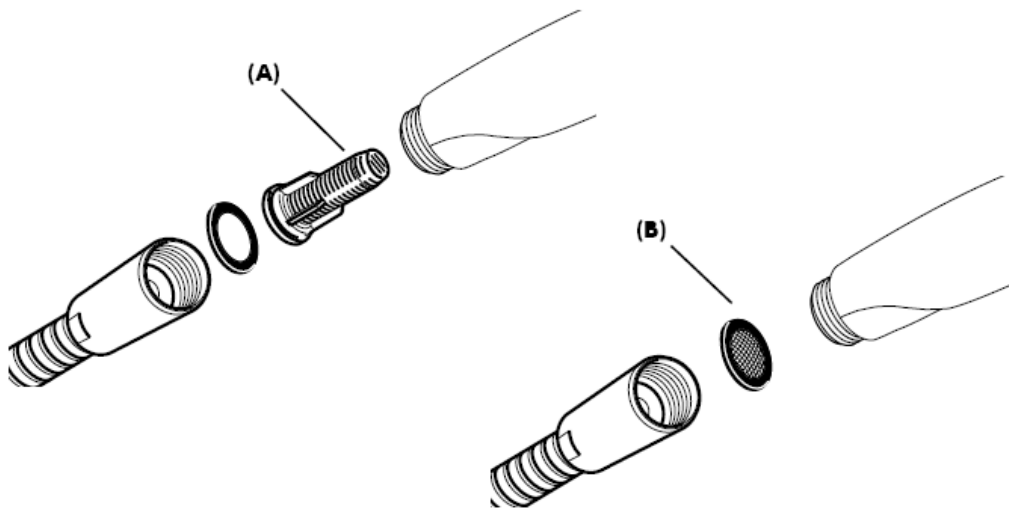

281000000

Me përdorim të filtrit (A)

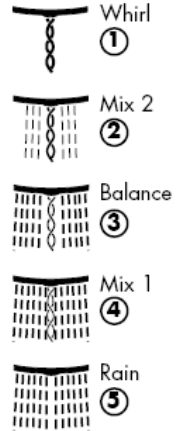
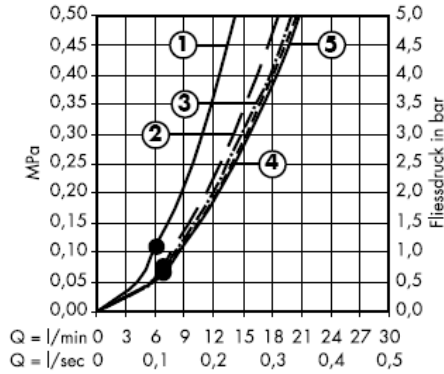

Me izolues të sitës (B)

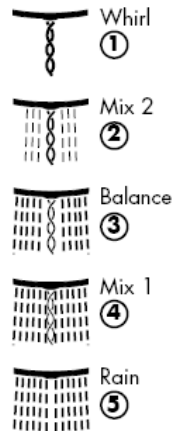
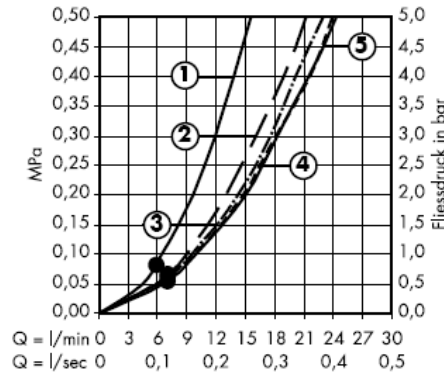

Nga • është i mundur funksioni.

Me përdorim të filtrit (A)

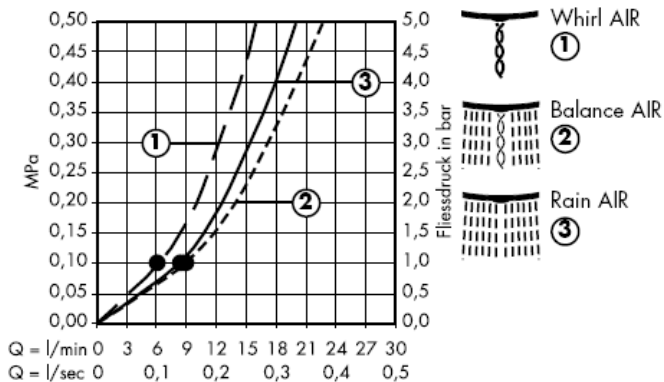

Me izolues të sitës (B)

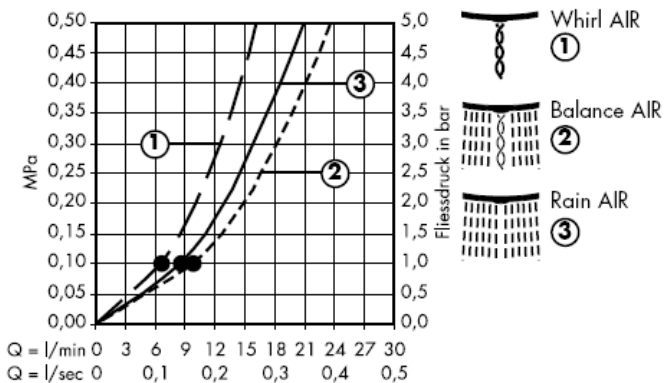

Nga • është i mundur funksioni.

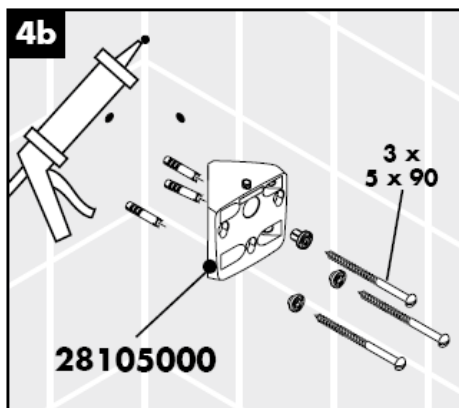
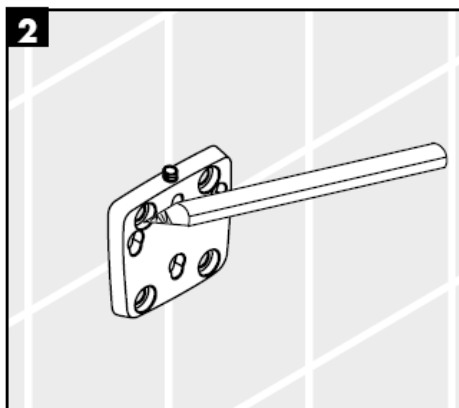

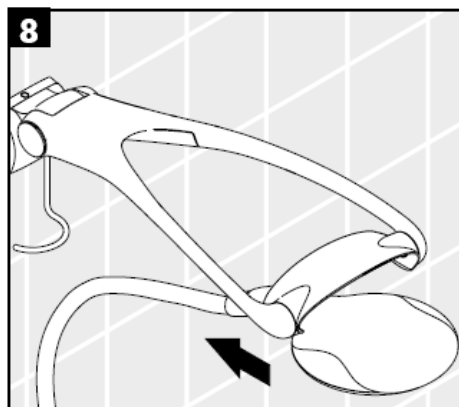
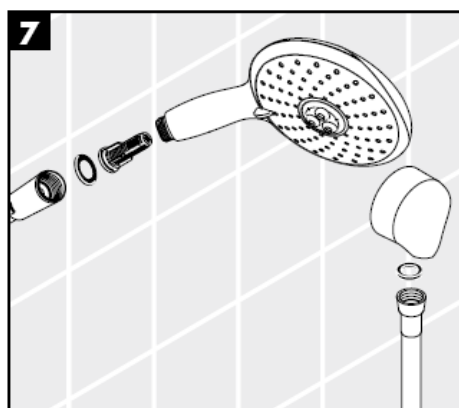
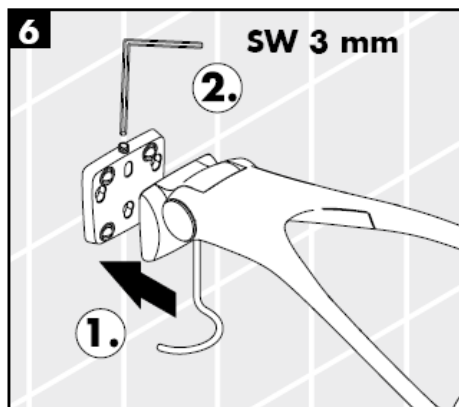
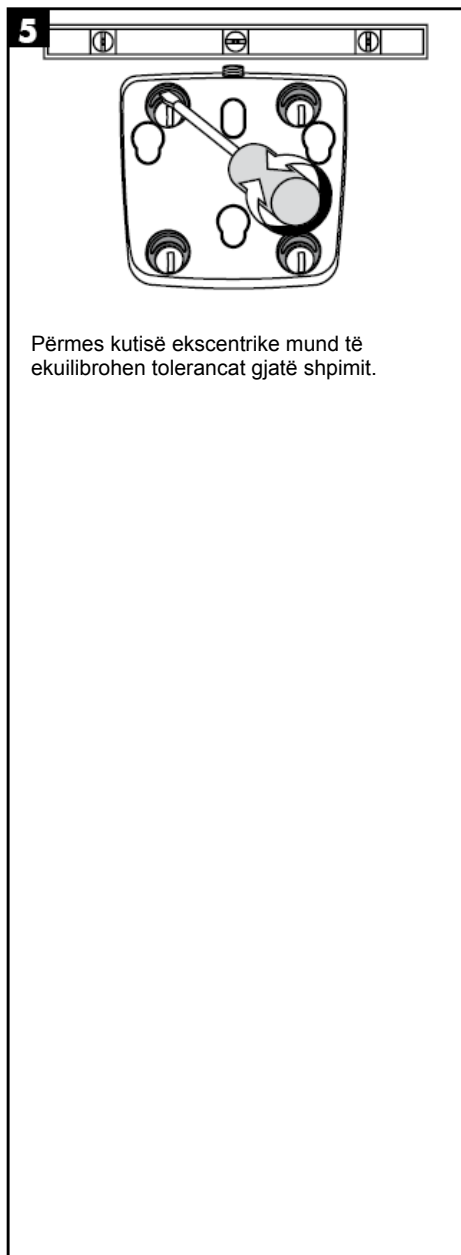

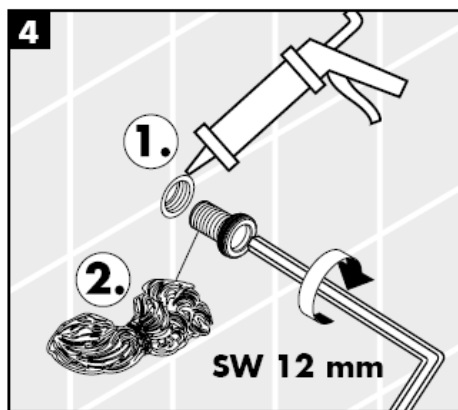
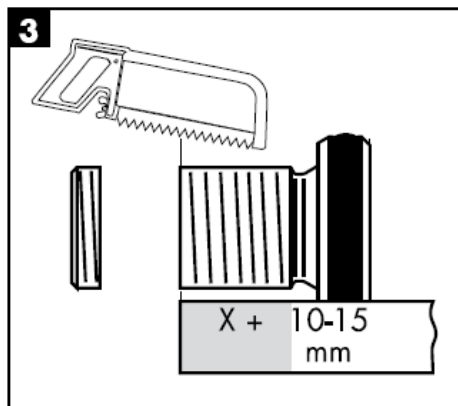
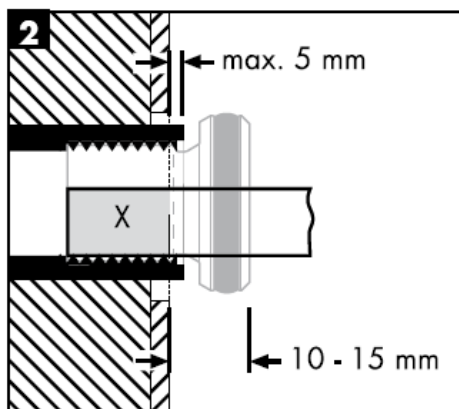
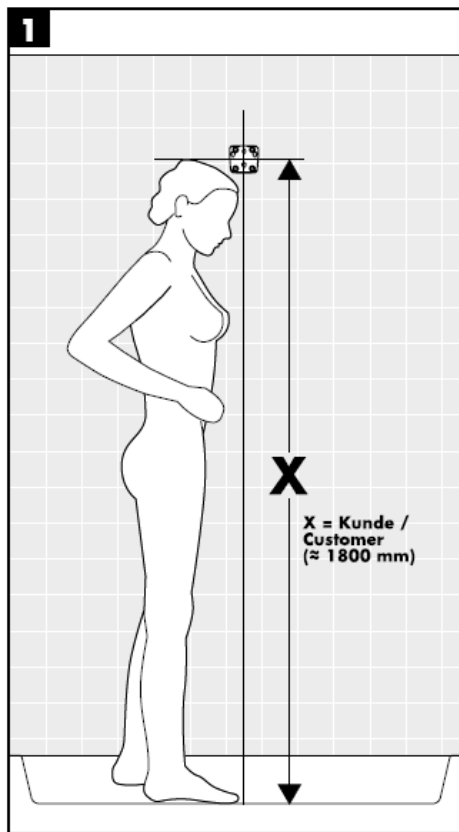

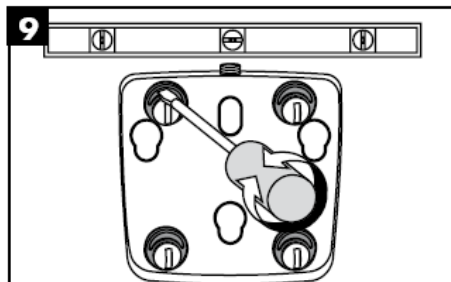
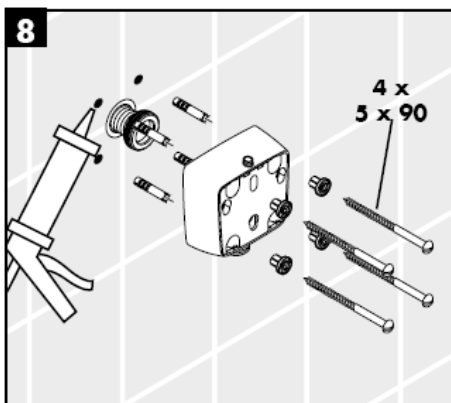
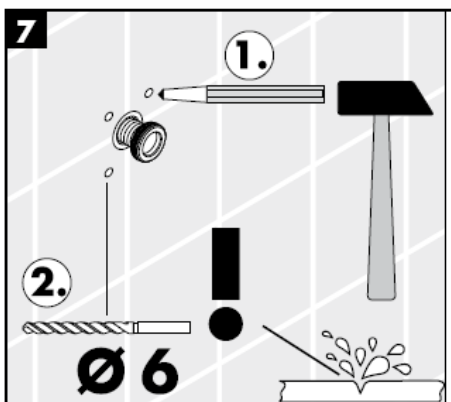
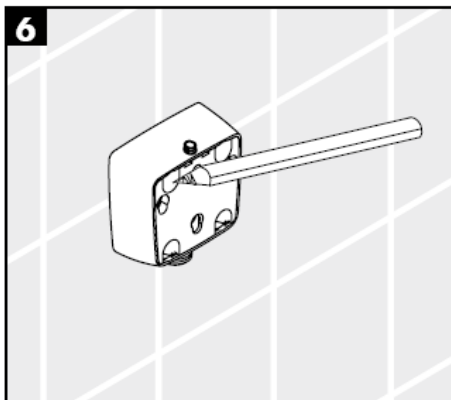

Përmes kutisë ekscentrike mund të ekuilibrohen tolerancat gjatë shpimit.





Kompleti Allrounder është një sistem multifunksional i spërkatëseve. Sipas pozicionit të dorës në formë harku mund të zgjidhen funksionet për spërkatësen e kokës, asaj anësore ose për spërkatësen separatë të dorës.

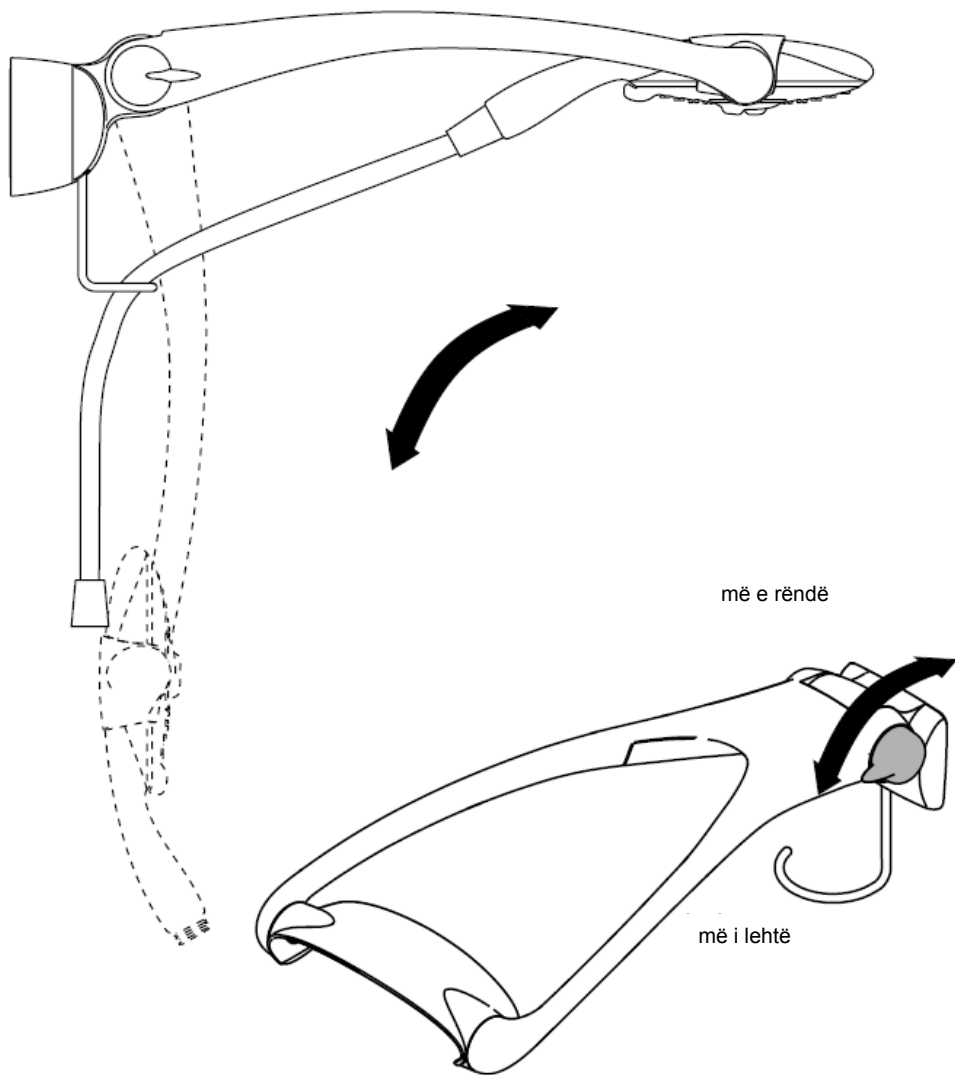

Me Rubit®, funksionin manual të pastrimit mund të hiqet kalku me fërkim të thjeshtë nga formuesit e currilit.

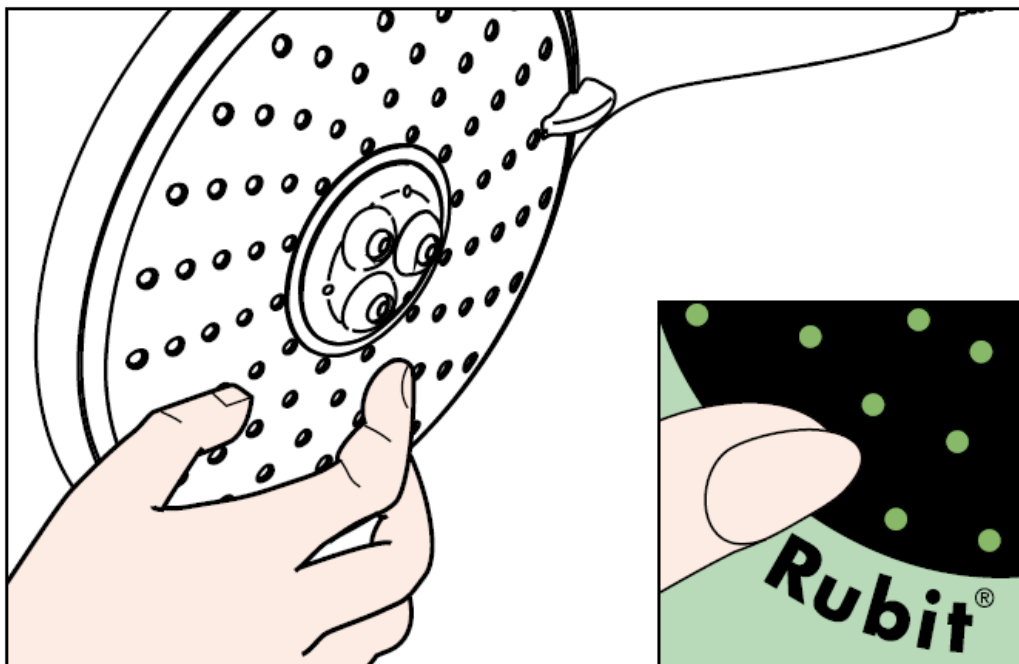

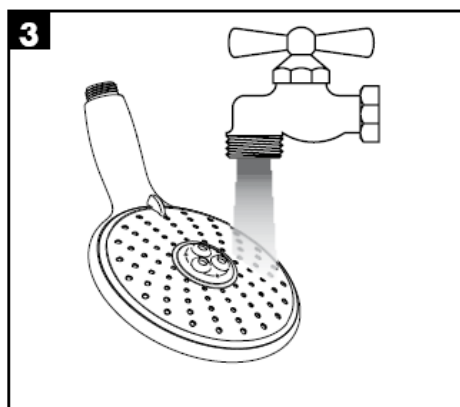
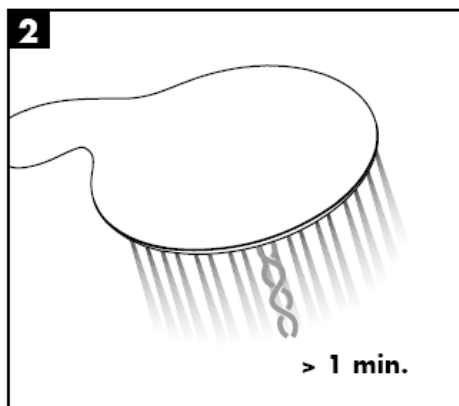
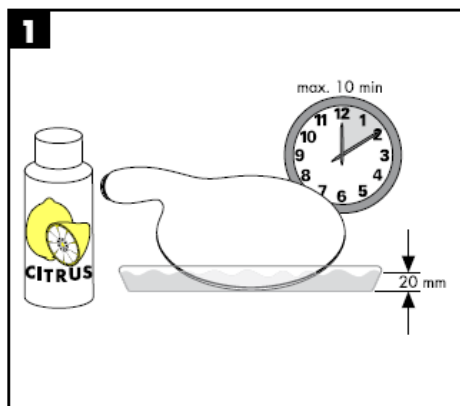

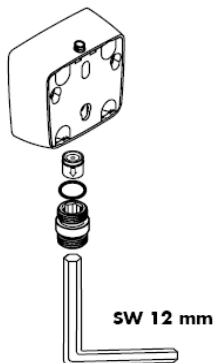

Kujdes!

Penguesit e rrjedhjes në drejtim të kundërt në bazë të normës DIN 1988 duhen kontrolluar njëherë në vit.

hansgrohe

Hansgrohe · Postfach 1145 · D-77761 Schiltach · Telefon +49 (0) 78 36/51-1282 · Telefax +49 (0) 7836/511440
E-Mail: info@hansgrohe.com · Internet: www.hansgrohe.com

02/2008
9.06081.04
Shqib