

- D** Montage
- E** Montaje
- F** Montage
- GB** Mounting
- I** Montaggio
- NL** Montage

Collection EDITION 300

Modell 30201

KEUCO

DIE MARKE FÜRS BAD

KEUCO GmbH & Co.KG
 Postfach 1365, D-58653 Hemer
 Telefon : 02372/904-0
 Telefax : 02372/904-236
 Internet: <http://www.Keuco.de>

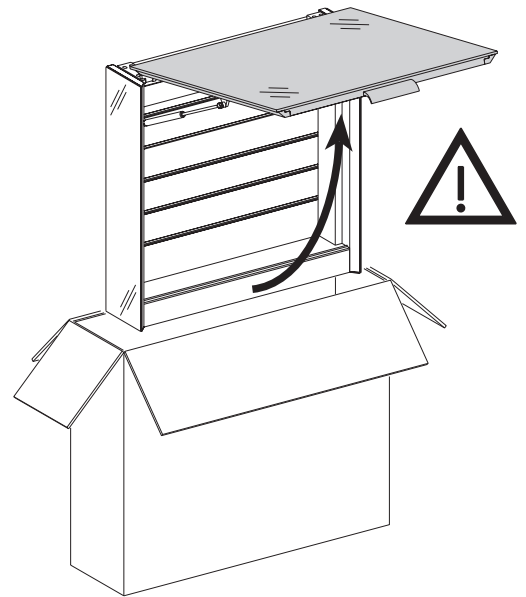

GB

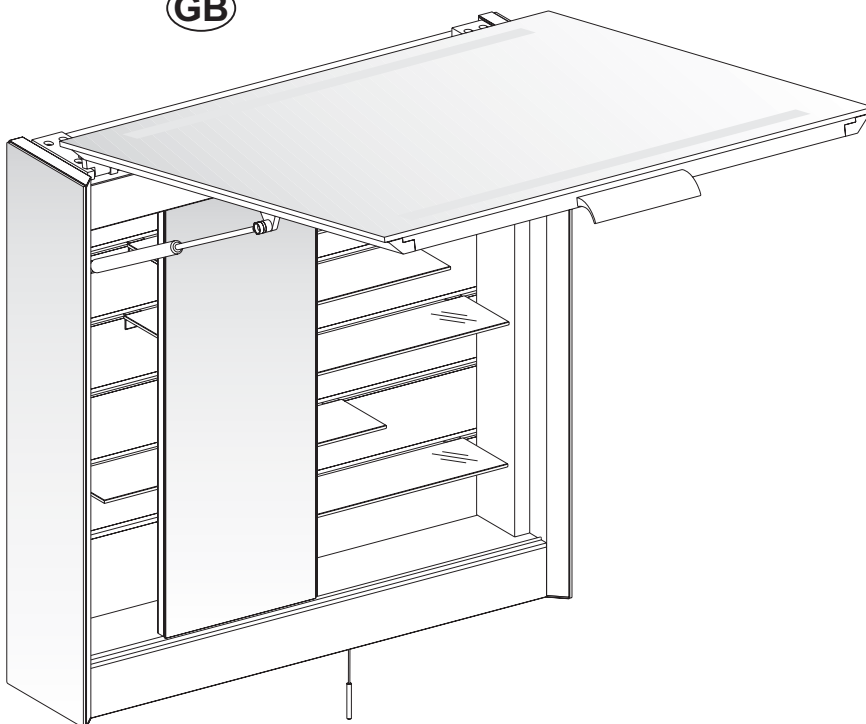

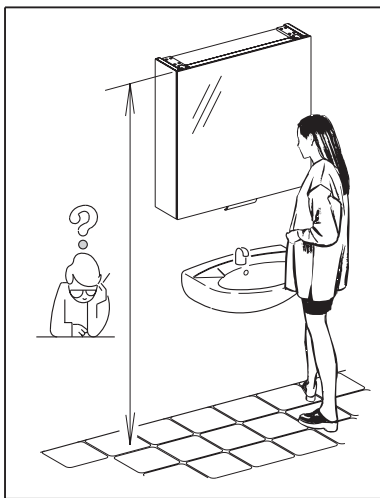
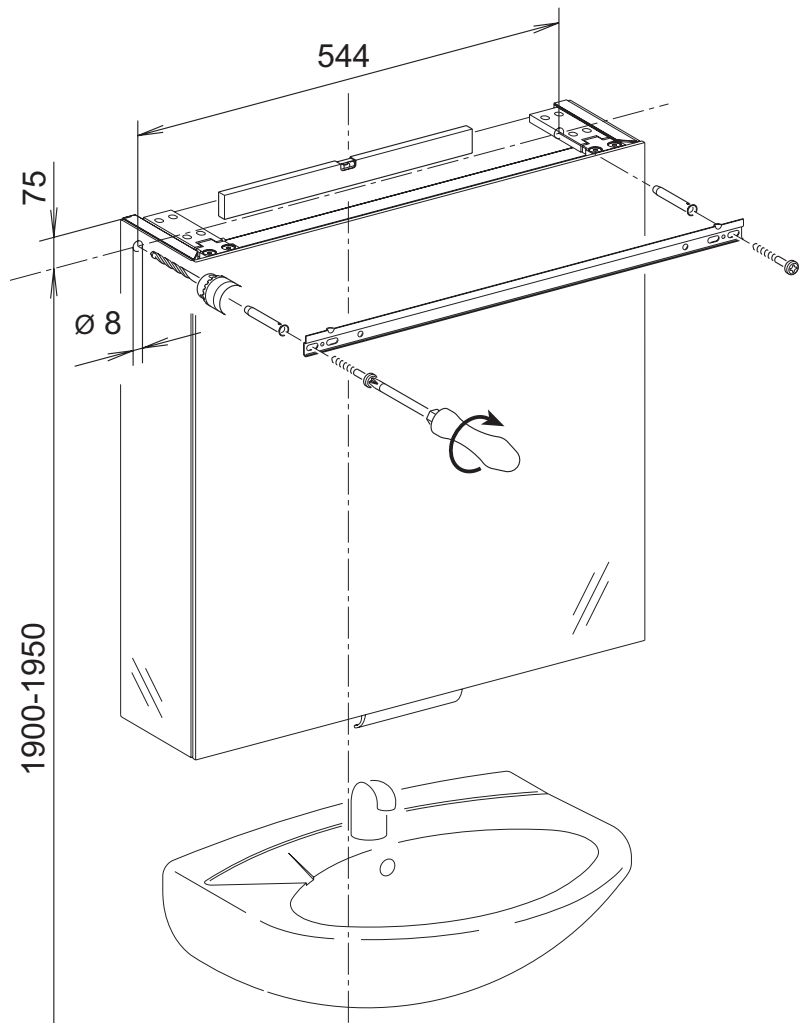
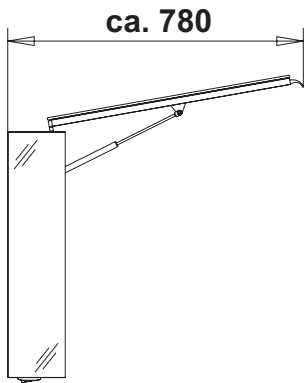
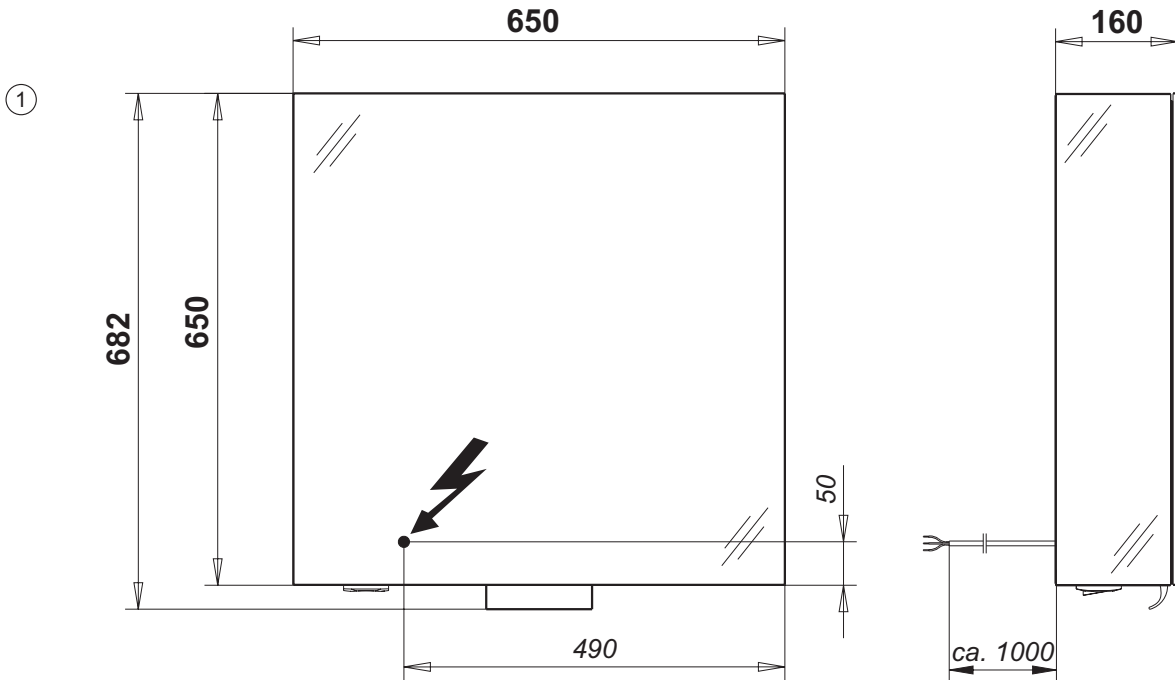

D Montagehinweis

Montage darf nur durch Fachmann erfolgen entsprechend VDE 0100 Teil 0701

GB Mounting Instructions

The Installation of our product should only be carried out by an "Approved Domestic Installer".

KEUCO strongly recommends that all its bathroom cabinets containing a 230 V supply should be protected by an RCD switch with a 30 mA protected circuit.

Our shaver supply unit complies with BS/EN 61558.

F Instruction de Montage

Montage et branchement par un professionnel

NL Montageaanwijzing

Montage geschied door geschoolde vaklui.

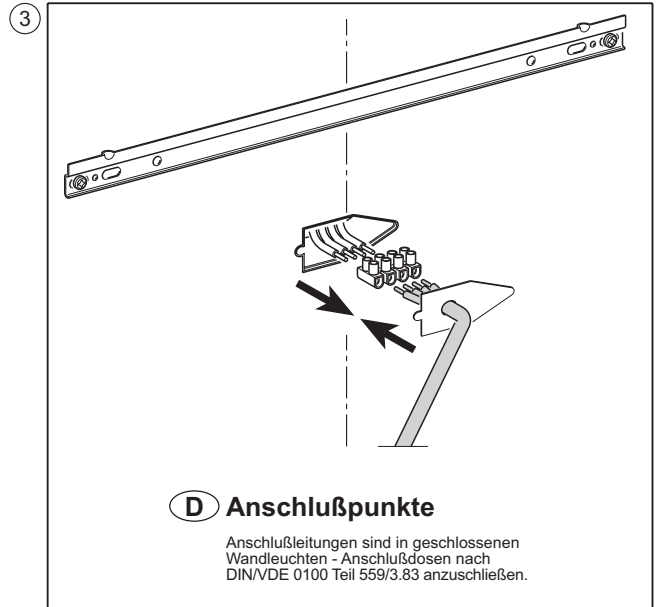
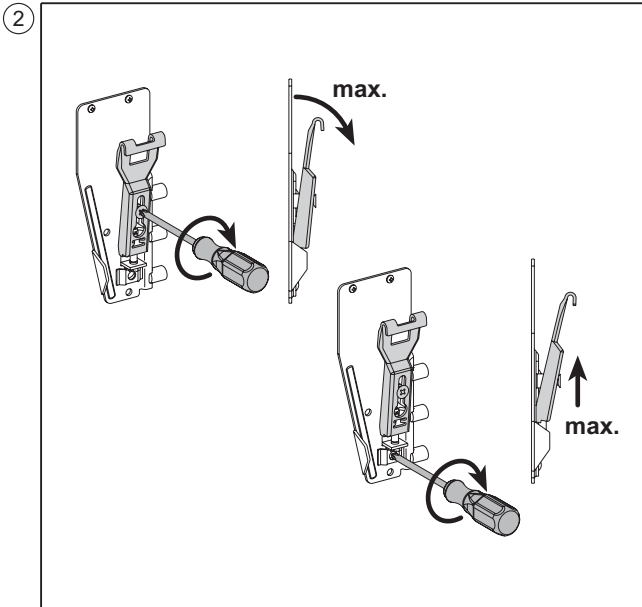

- D** Schaltplan
- F** Diagramme de connexion
- NL** Schakel plan

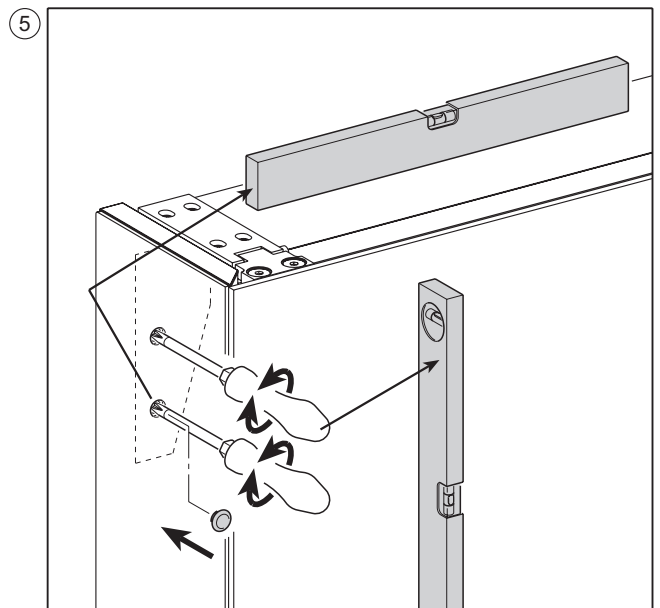
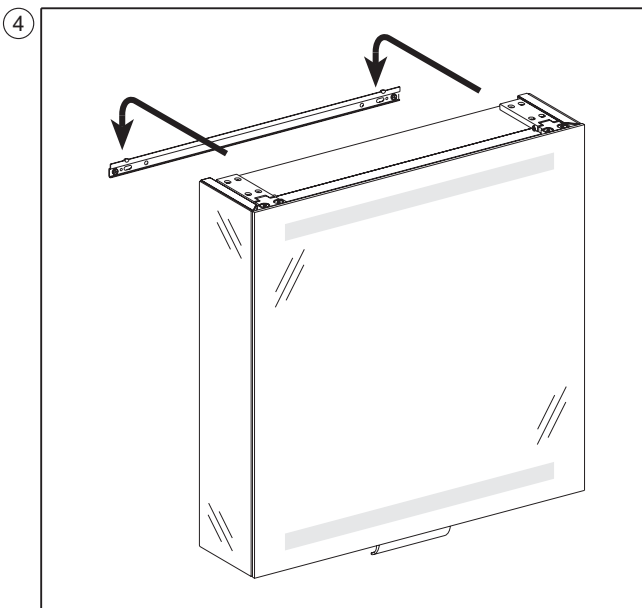
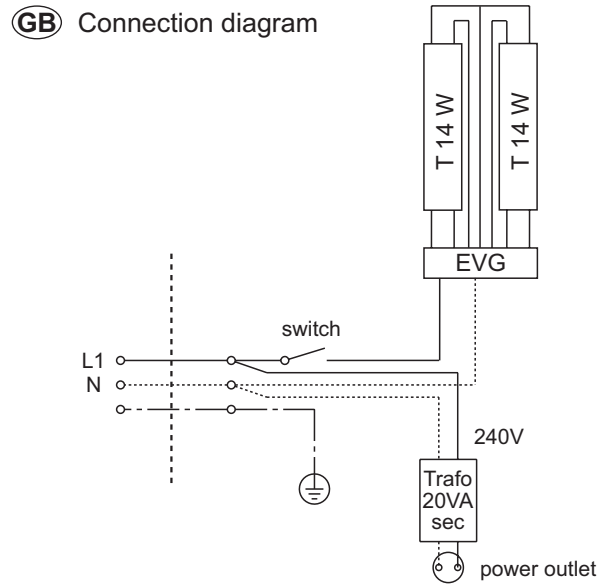
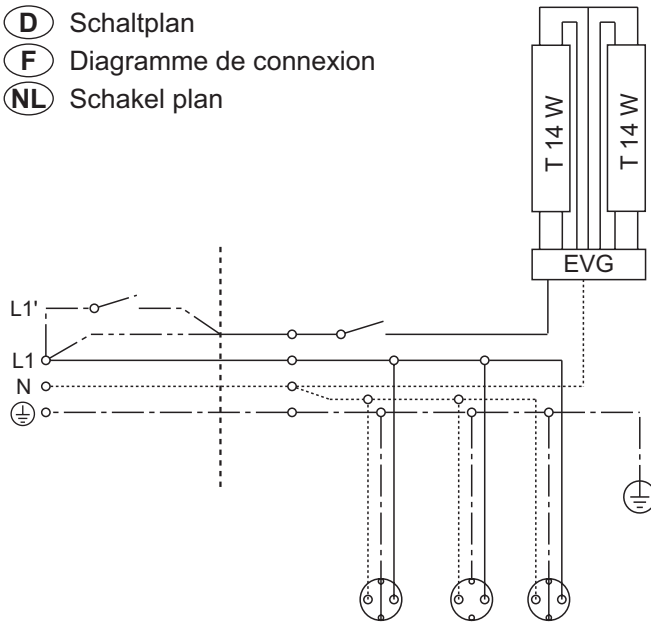

6

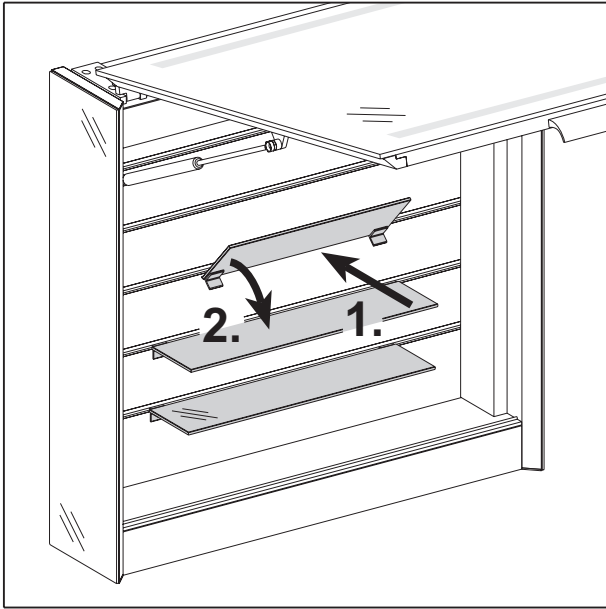

7

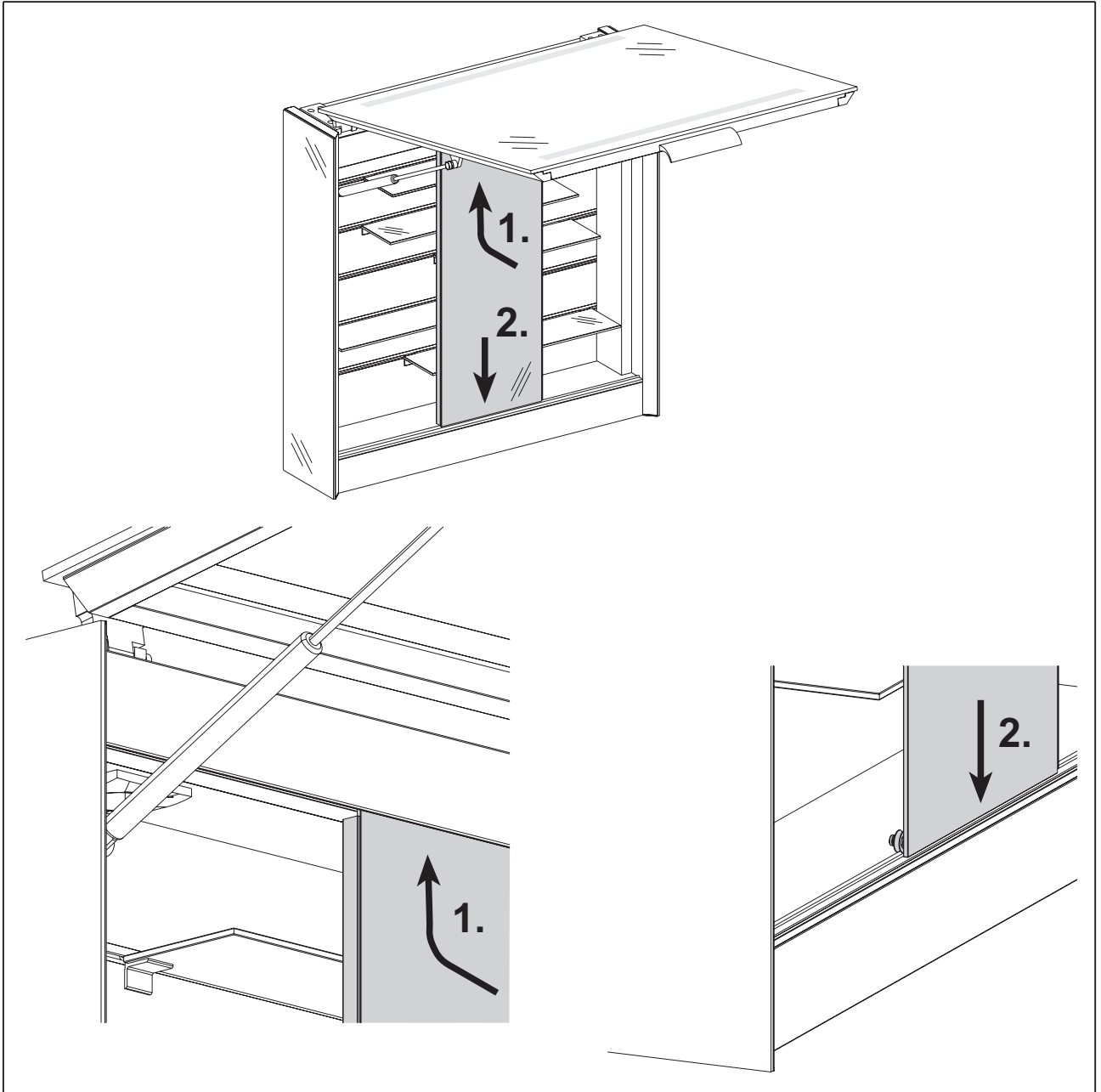

i

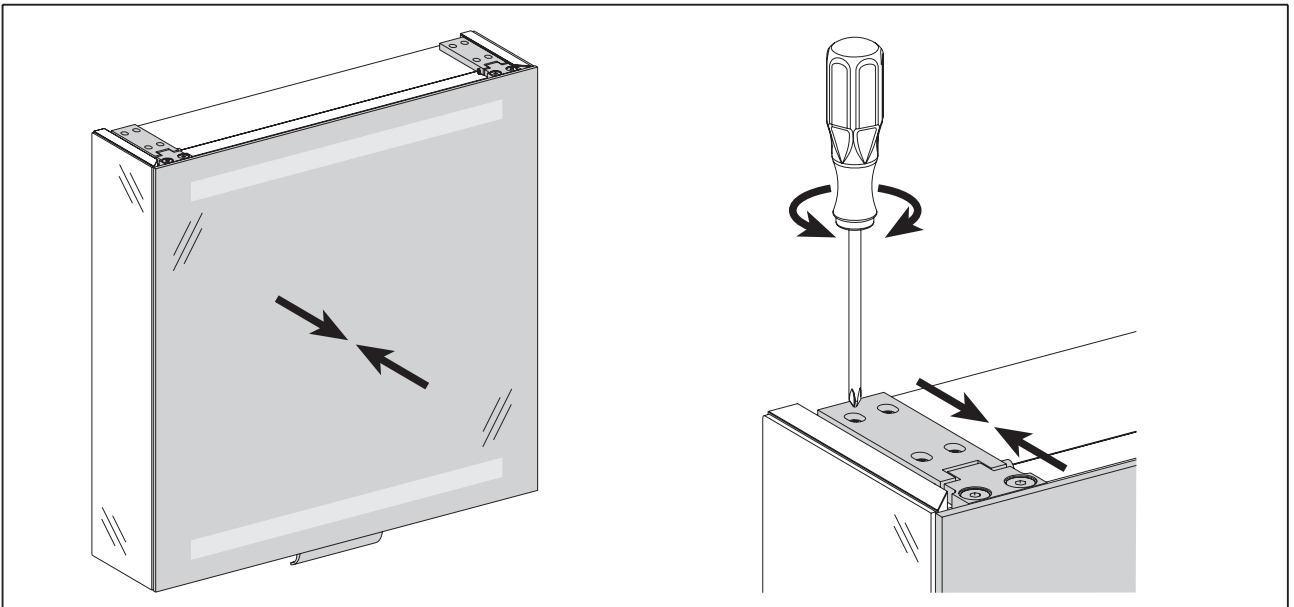

i

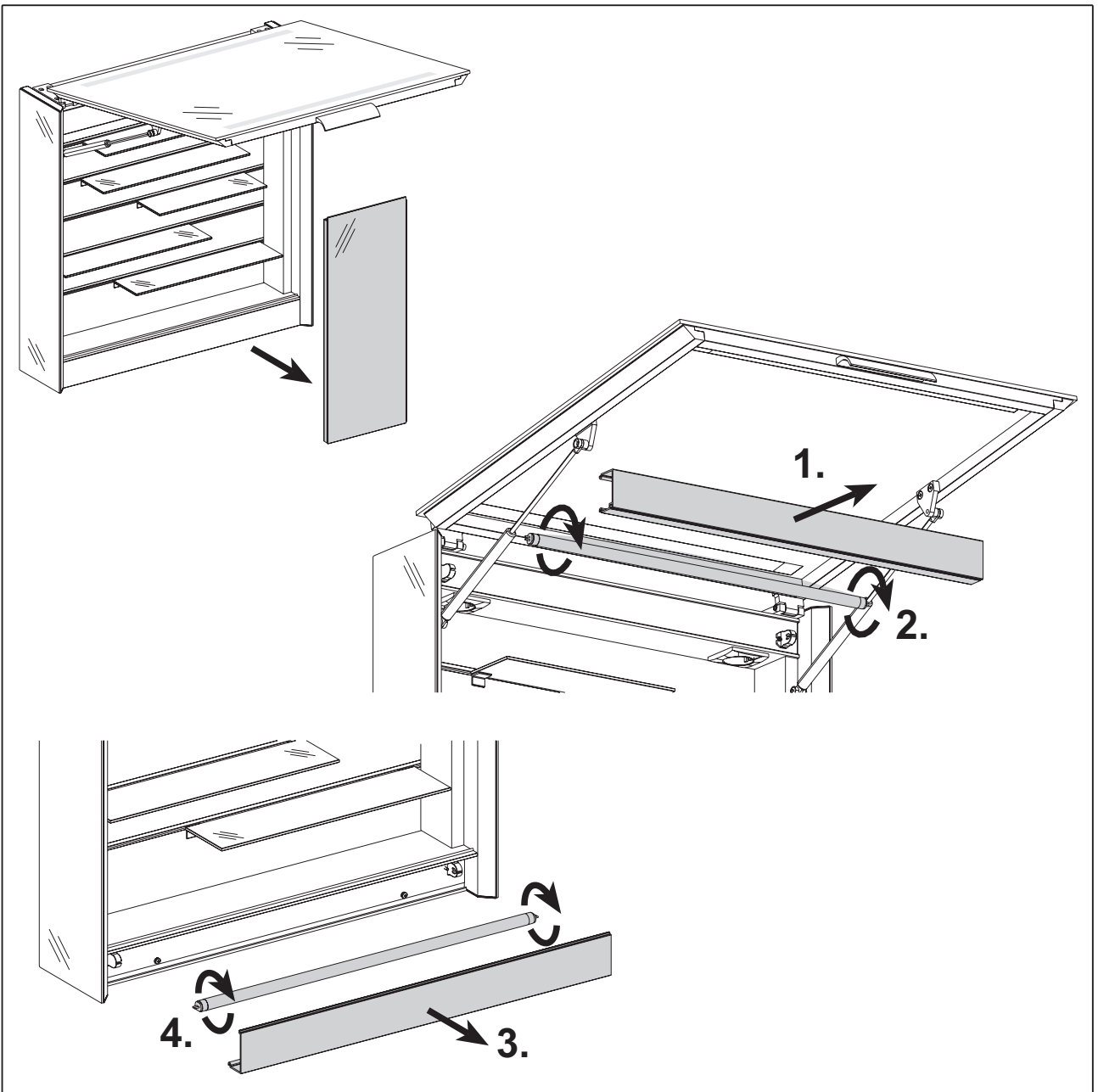

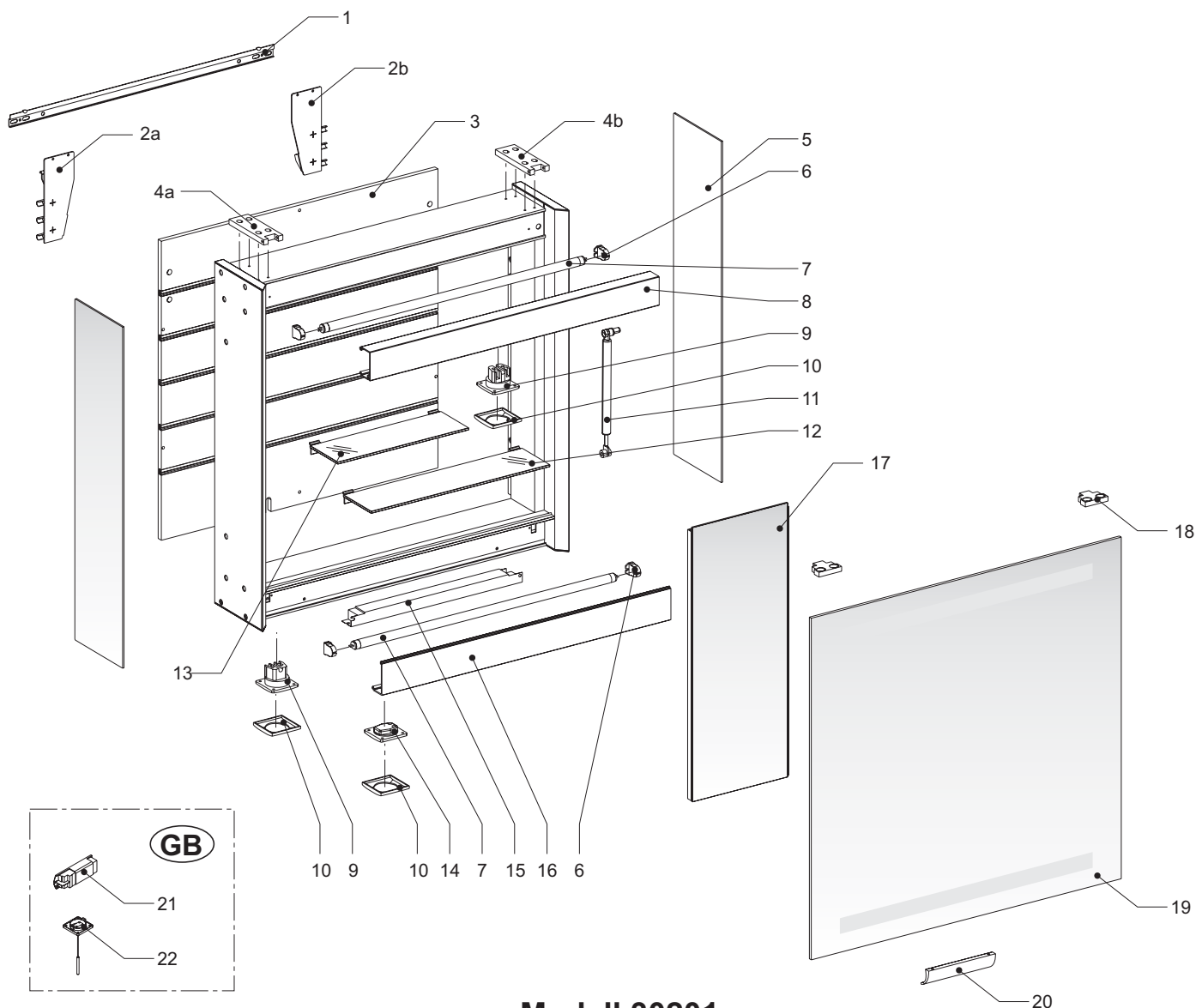

Modell 30201

Nr.	Anzahl	Bezeichnung		Artikel-Nr.
1	1	Aufhängeleiste	570 mm	307180
2a	1	Schrankschrauber SH-5301 links		306326
2b	1	Schrankschrauber SH-5301 rechts		306327
3	1	Rückwand mit Trägerprofil	590 x 569 x 10 mm	308619
4a	1	Scharnierlager links		309195
4b	1	Scharnierlager rechts		309194
5	2	Seitenspiegel	151 x 649 x 3 mm	308626
6	4	Fassung G5		309246
7	2	Leuchtstofflampe TL5 14 Watt	Ø16 x 549 mm	308985
8	1	Leuchtenblende oben	605,5 mm	308605
9	3	Steckdose, grau		308654
10	4	Rahmen 1-fach, grau		308655
11	2	Gasfeder 150N		221255
12	3	Glasablage mit Halter	375 x 90 x 6 mm	30290179300
13	2	Glasablage mit Halter	275 x 90 x 6 mm	30290179200
14	1	Ausschalter, grau		308657
15	1	Elektronisches Vorschaltgerät		308394
16	1	Leuchtenblende unten	605,5 mm	308603
17	1	Schiebetür	200 x 522 mm	406082
18	2	Scharnier		309193
19	1	Schwenktür mit Griff	650 x 650 mm	406141
20	1	Griff	140 mm	59430-01
21	1	Trenntrafo für GB-Ausführung		306566
22	1	Zugschalter für GB-Ausführung		406417